

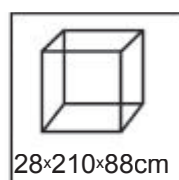

No. 424 - Sea Horse

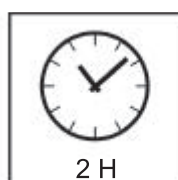

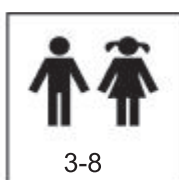

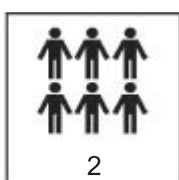
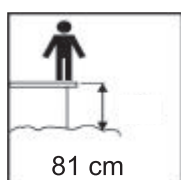
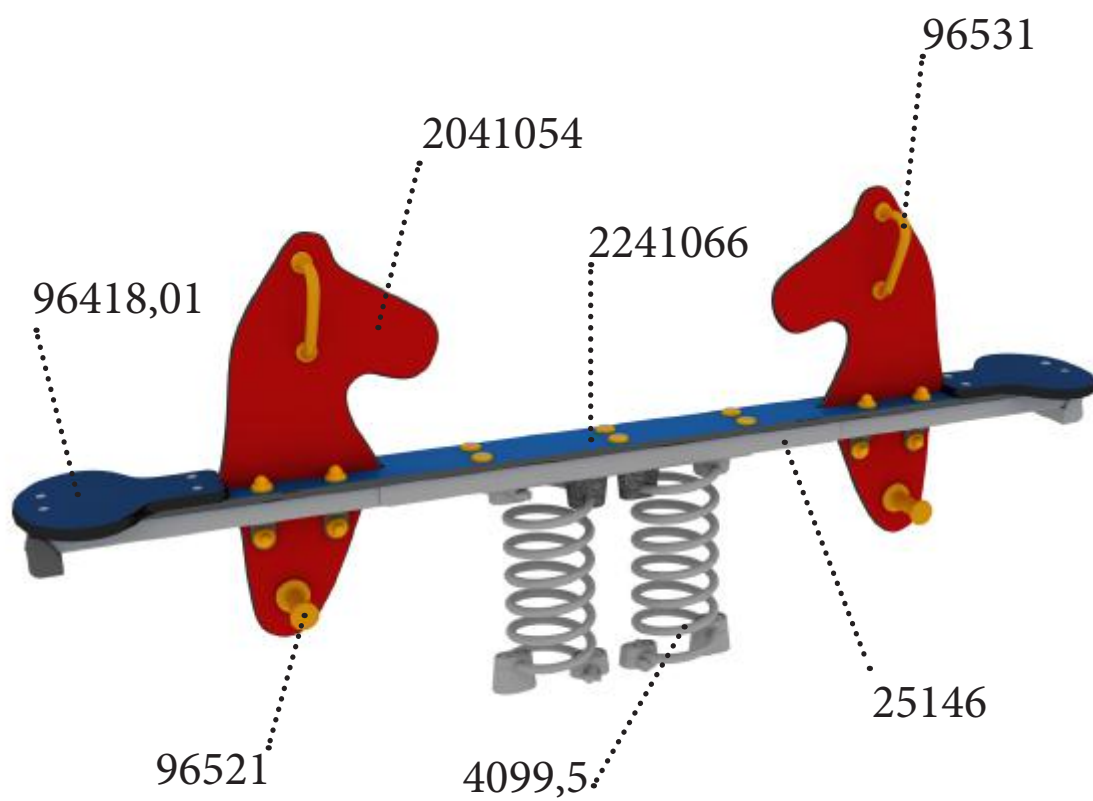

Faldunderlag: I overensstemmelse med EN 1177

Safety surface: In accordance with EN 1177

Fallschutzbelag: Gemäß EN 1177



Zone D'impact d'après norme EN 1177

Fundamento de caída según norma EN 1177

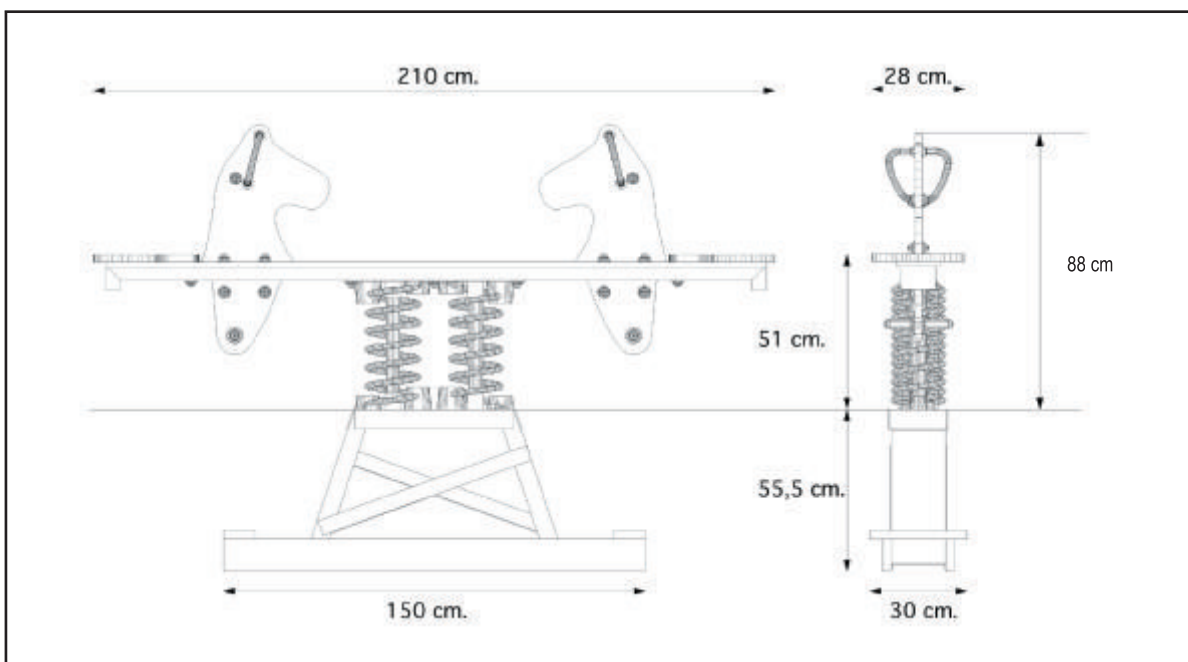
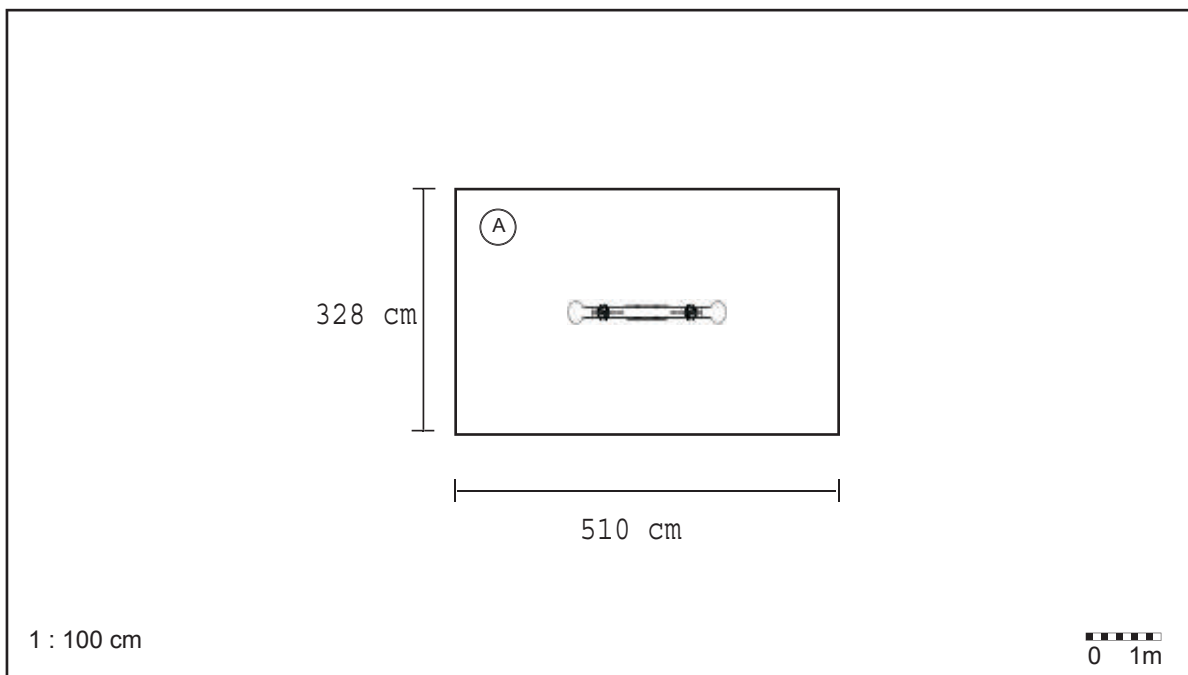
		
(A)	81 cm	16,73 m ²

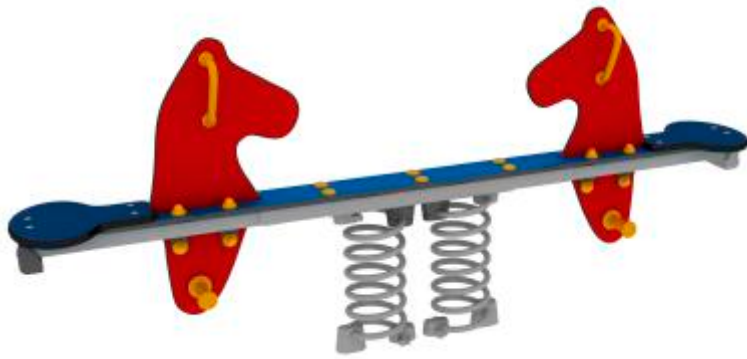



6 Pcs.		GT
2 Pcs.		1475 mm
2 Pcs.		285x90x15 mm
2 Pcs.		730x90x15 mm

