

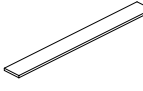

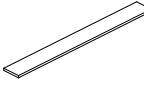

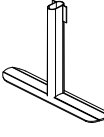





① 709059	PCS	② 709060	PCS
	2		1
1520x155x20		1520x155x20	
③ 905234	PCS	④ 905223	PCS
	2		1
		1334x415x73	
⑤ 909850	PCS	⑥ 909256	PCS
	8		16
M8x25		Ø17/8.5	
⑦ 980160	PCS	⑧ 901093	PCS
	8		18
M8		M6x30	8
⑨ 980158	PCS	⑩ 980157	PCS
	18		18
Ø12/6.4	9	M6	
		⑪ 702341	PCS
			1
		90x50	



060141M	① 709059	PCS	HPL PARTS COLOR OPTIONS:	
		2	-701 (BLUE) -702 (YELLOW) -703 (LIME) -704 (DARK GREY) -705 (LIGHT GREY) -706 (RED) -707 (GREEN) -708 (FUCHSIA)	
	1520x155x20			
	② 709060	PCS		
	1			
1520x155x20				
③ 905234	PCS	METAL PARTS COLOR OPTIONS:		
	2	-205 (GRAPHIT GREY) -207 (BLACK) -209 (GREEN) -299 (SPECIAL COLOUR)		
④ 905223	PCS			
	1			
1334x415x73				

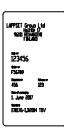
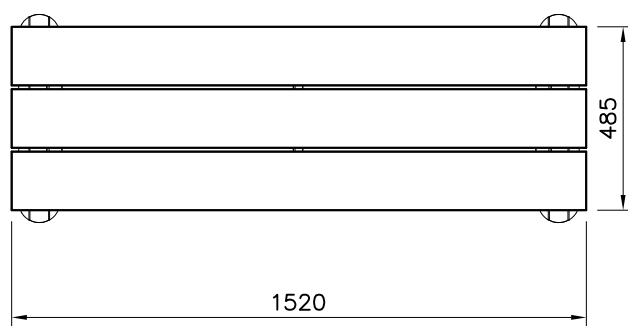
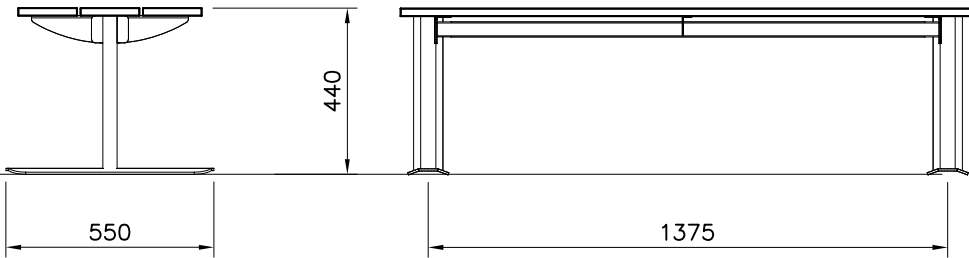
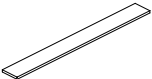

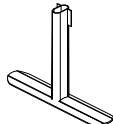
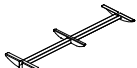
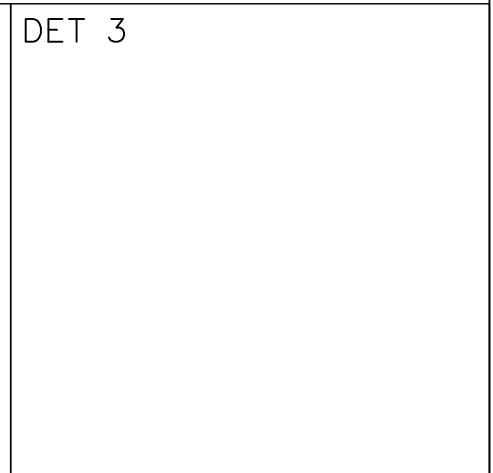
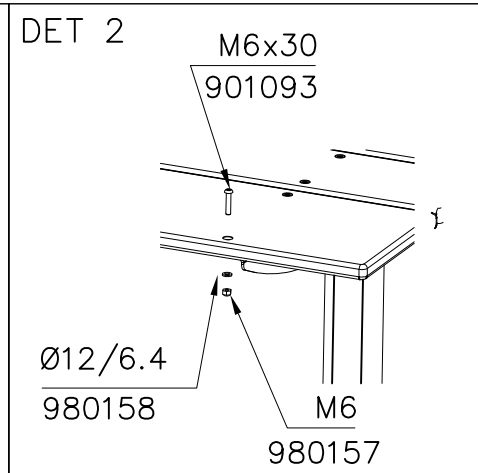
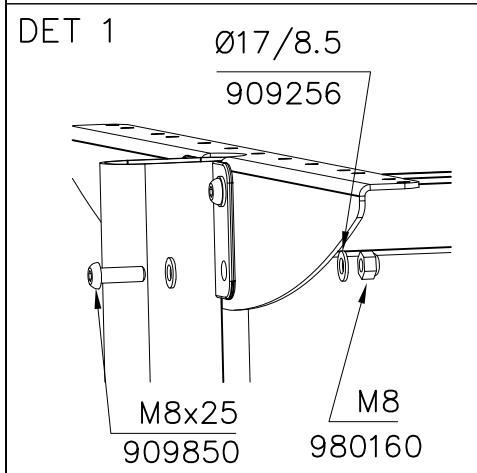

**Tuotekyltti tulee tuotteen mukana yhdellä seuraavista tavoista:**

**1) Metallinen tuotekyltti ja kiinnitysruuvit**

- Kiinnitä tuotekyltti ruuveilla tolppaan noin 2 metrin korkeuteen kuvan 2 mukaisesti.

**2) Tuotekylttitarra**

- Puhdista maalattu metalli- tai vaneripinta pölystä ja kosteudesta. Liimaa tarra kuvan 3 mukaisesti.
- Huom. Älä kiinnitä tarraa karheapintaiseen laminaattiin tai maalattuun puuhun.

**Vår produktmärkning levereras på ett av följande sätt:**

**1) Produktskylt i metall**

- Fäst skylten med de medföljande skruvarna

**2) Självhäftande produktetikett**

- Rengördenpulverlackerademetallytanellerlaminatytansåattdenblirfrifrånsmutsochfukt.Fästetikettenenligtfig.3.
- Obs! Fäst ej etiketten på detaljer med skrovlig yta eller på målat trä.

**Product label is delivered by one of following ways:**

**1) Metal product label and screws**

- Fasten the label with screws.

**2) Label sticker**

- Cleanthepaintedmetalorplywoodsurfacefromdirtandmoisture.Fastenthestickerasshowninthefigure3.
- Note. Do not attach the sticker to rough surfaced laminate or painted wood.

**La plaque d'informations produit est livrée sous l'une de ces 3 formes :**

**1) Plaque métallique et vis**

- Fixez la plaque à l'aide des vis.

**2) Etiquette autocollante**

- Avant de coller l'étiquette, nettoyez le composant métallique peint ou la plaque de contreplaqué, de toute saleté. La surface doit être sèche (voir image 3).
- Attention, ne pas coller l'étiquette sur une surface lamellé-collée irrégulière ou sur du bois peint.

**Die Auslieferung des Produktaufklebers erfolgt auf eine dieser Arten:**

**1) Produkt-Schild aus Metall incl. Schrauben**

- Die Befestigung des Schildes erfolgt mittels der Schrauben.

**2) Aufkleber**

- EntfernenSiezunächstSchmutzundFeuchtigkeitvomlackiertenMetallbzw.vonderHolzoberflächeundbringenSiedenAufkleber wie im Bild oben rechts beschrieben auf den gesäuberten Untergrund auf.
- Beachten Sie: Bringen Sie den Aufkleber nicht auf raues laminiertes oder lackiertes Holz an.