

LEDON®

No. 1467 - Ground

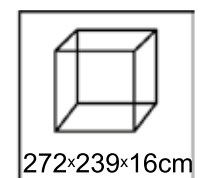

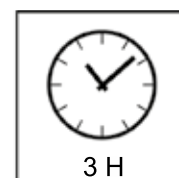
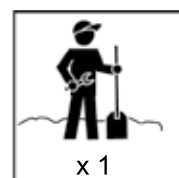
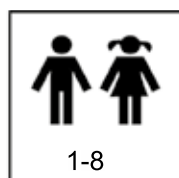
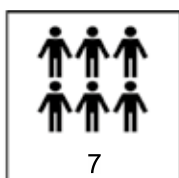
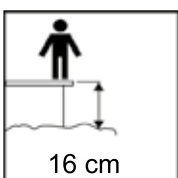
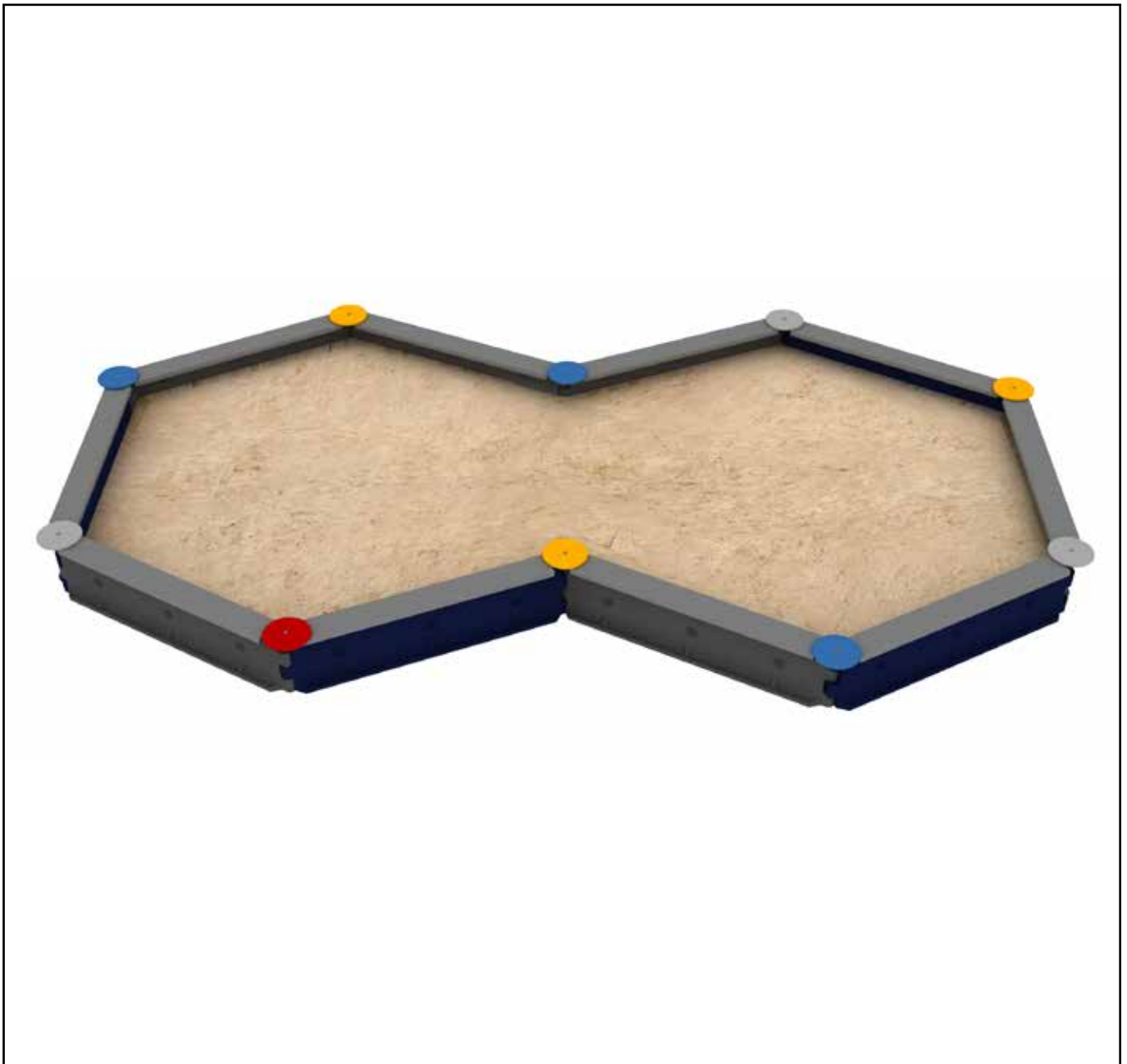
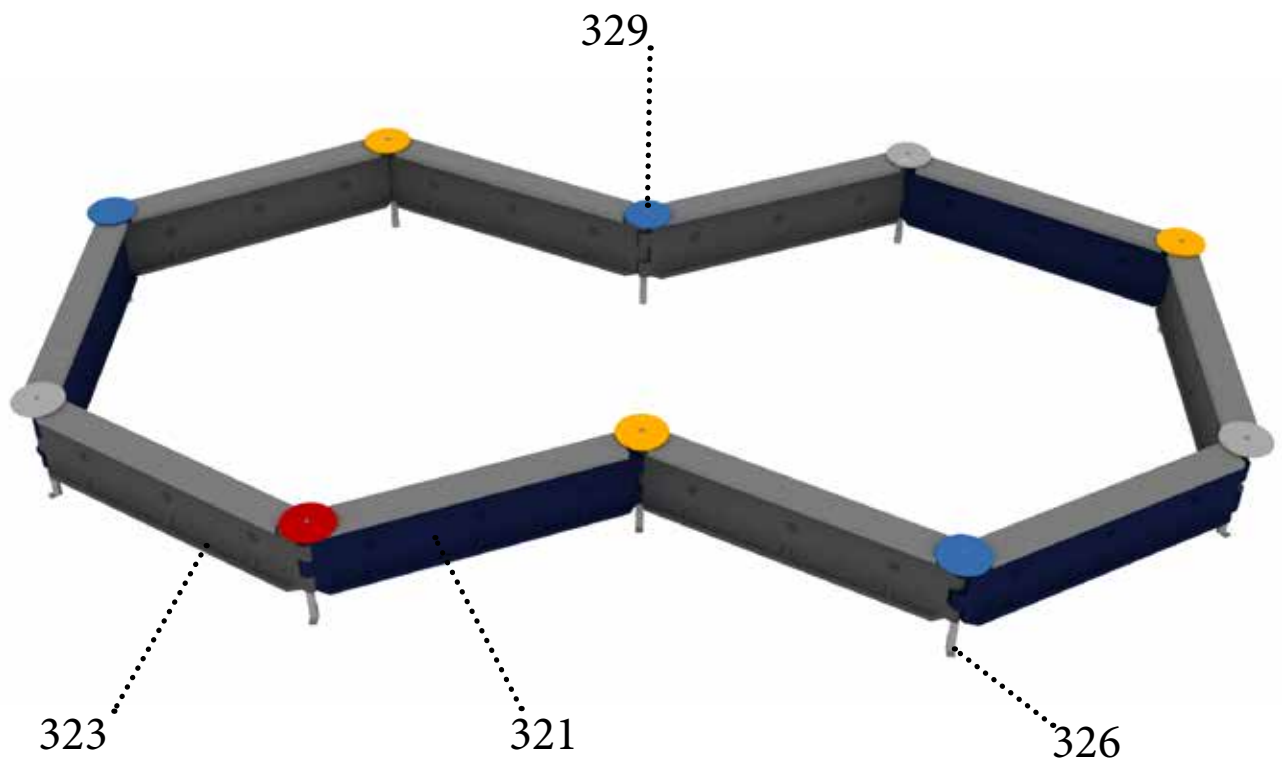

Faldunderlag: I overensstemmelse med EN 1177

Safety surface: In accordance with EN 1177

Fallschutzbelag: Gemäß EN 1177

Zone D'impact d'après norme EN 1177

Fundamento de caída según norma EN 1177

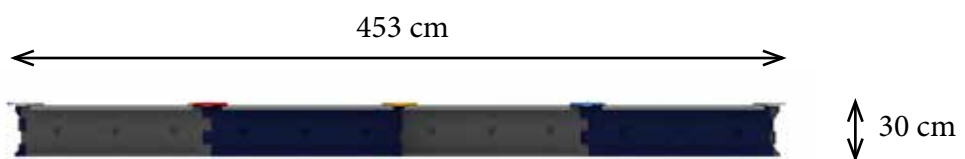
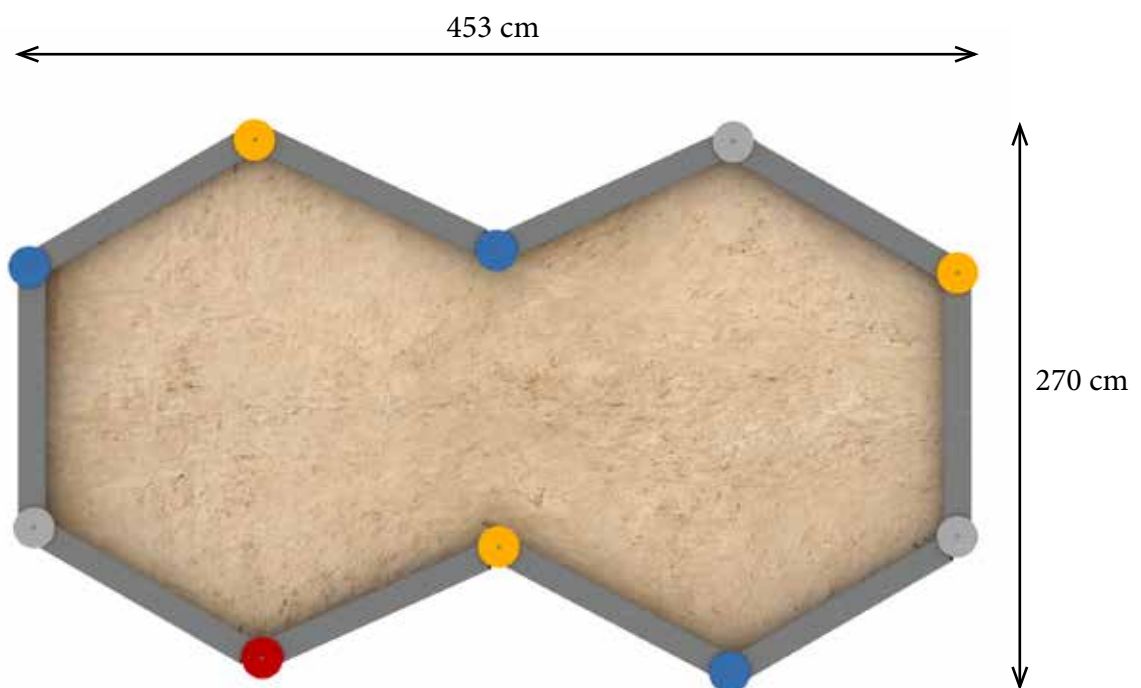
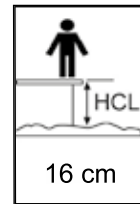

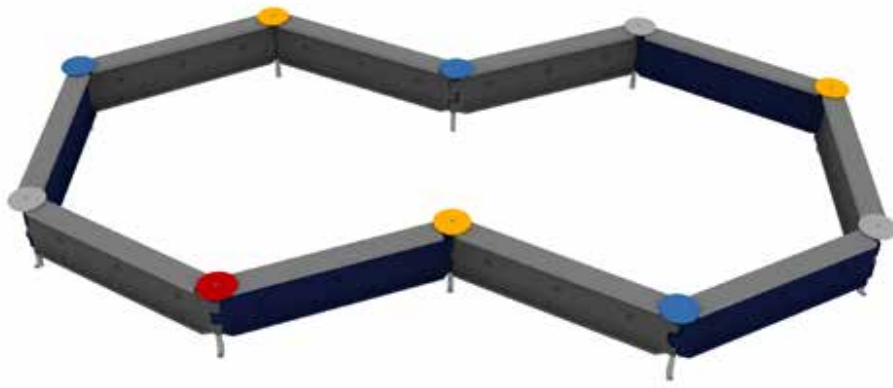

Fig. 1

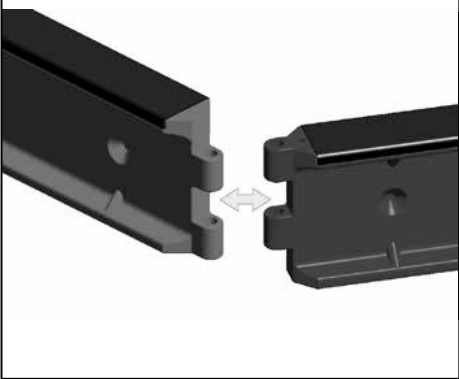

Fig. 2

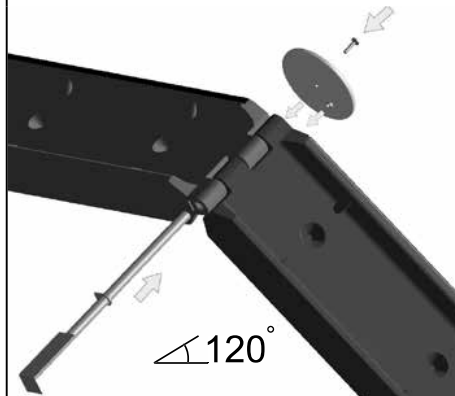

Fig. 3

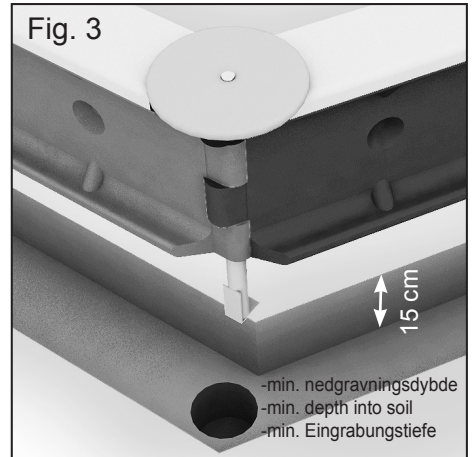

Fig. 4

