



Mini Brandbil / Politibil

Mini Firetruck / Polickeyar

304010 / 303010 (Concrete)

Montageanvisning • Assembly instructions • Montageanleitung
Instrucciones de montaje • Instrucciones de montaje

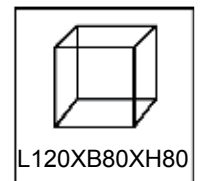
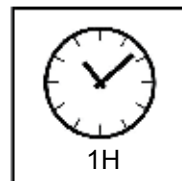
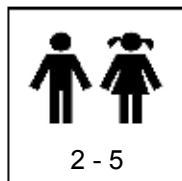
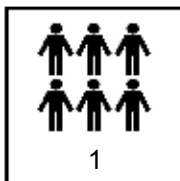
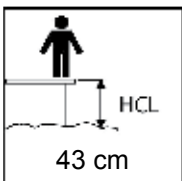

Indholdsfortegnelse

Ⓚ	Gode råd og vink	3
	Komponentorientering	4
	Montage 1	5
	Finish	6
Ⓜ	Contents	
	Some good advice and tips	3
	Components overview	4
	Assembly 1	5
	Finish	6
Ⓛ	Inhaltsverzeichnis	
	Ein paar gute Ratschläge und Tipps	3
	Bauteileübersicht	4
	Montage 1	5
	Finish	6
Ⓧ	Sommaire	
	Quelques bons conseils et astuces	3
	Vue d'ensemble des composants	4
	Assemblage 1	5
	Fin du montage	6
Ⓨ	Inhaltsverzeichnis	
	Algunos consejos buenos	3
	Descripción de componentes	4
	Asamblea 1	5
	Finalizar	6

Gode råd og vink

- ⒹⓀ 1. Tag komponenterne af pallen og læg dem på jorden
2. Check efter komponentlisten om alle er med
3. Vær omhyggelig med afstande generelt
4. Pak én komponent ud af gangen og gør denne færdig
5. Vær omhyggelig med brug af vatterpas
6. Faldunderlag etableres til allersidst sammen med påsætning af mærkning med producent
- ⒼⓅ **Some good advice and tips**
1. Take all components from the pallet and place them on the ground
2. Compare with components list – is everything there?
3. Be at all times precise when measuring
4. Unpack one component at a time and assemble it
5. Usage of a water-level will increase precision
6. Fall protection is the very last thing to be installed – along with the producer's label
- Ⓓⓔ **Ein paar gute Ratschläge und Tipps**
1. Alle Bauteile von der Palette nehmen und auf den Boden legen.
2. Anhand der Bauteilleiste überprüfen, ob alle Teile vorhanden sind
3. Beim Abmessen generell präzise arbeiten
4. Ein Bauteil nach dem anderen auspacken und montieren
5. Die Benutzung einer Wasserwaage erleichtert die Montage
6. Die Fallschutzunterlage wird erst ganz zum Schluss verlegt – dann, wenn das Produzentenetikett angebracht wird
- ⒻⓇ **Quelques bons conseils et astuces**
1. Prendre tous les composants de la palette et les positionner sur le sol
2. Comparer avec la liste des composants - avons-nous tous les éléments ?
3. Toutes les mesures doivent être effectuées avec précision
4. Déballez un élément à la fois et assemblez le
5. L'utilisation d'un niveau à eau améliore la précision du montage
6. Le sol de réception est la dernière chose à installer selon les prescriptions requises par le fabricant
- ⒺⓈ **Ein paar gute Ratschläge und Tipps**
1. Tome todos los componentes de la plataforma y colocarlos en el suelo
2. Comparar con la lista de componentes – ¿esta todo?
3. Sea preciso con las medidas y en medir.
4. Desembalar un componente a la vez y monta lo
5. El uso de un nivel es necesario. Si no se complica la vida en montar lo ultimo.
6. Losetas/ Goma el la zona de caída es lo último que se instalen - junto con la platina del fabricante.

Komponentorientering • Components overview • Bauteileübersicht Liste des composants • Lista de components

73129 / 73126

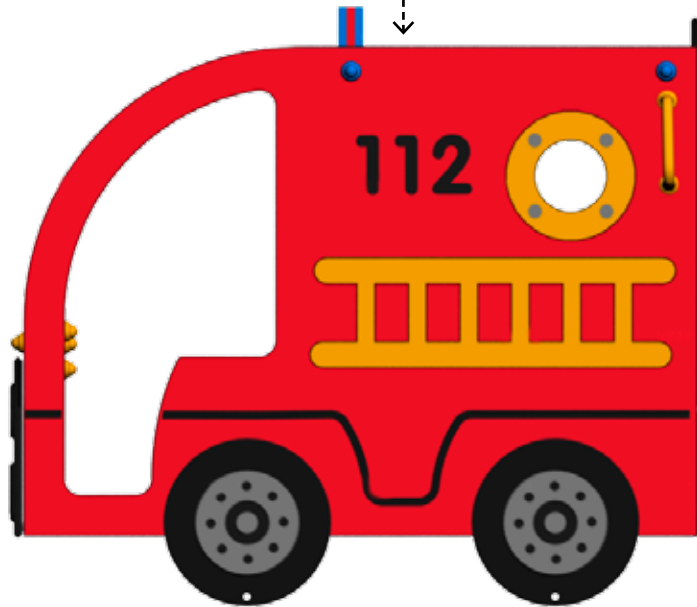

2 x
37031 / 37032



Note:

Color depends on the product.

4 x
10 x 30

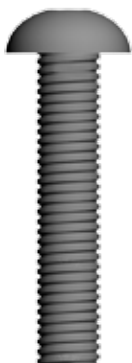

4 x
8 x 30



4 x
Ø8

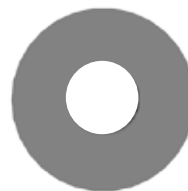

4 x
Ø8



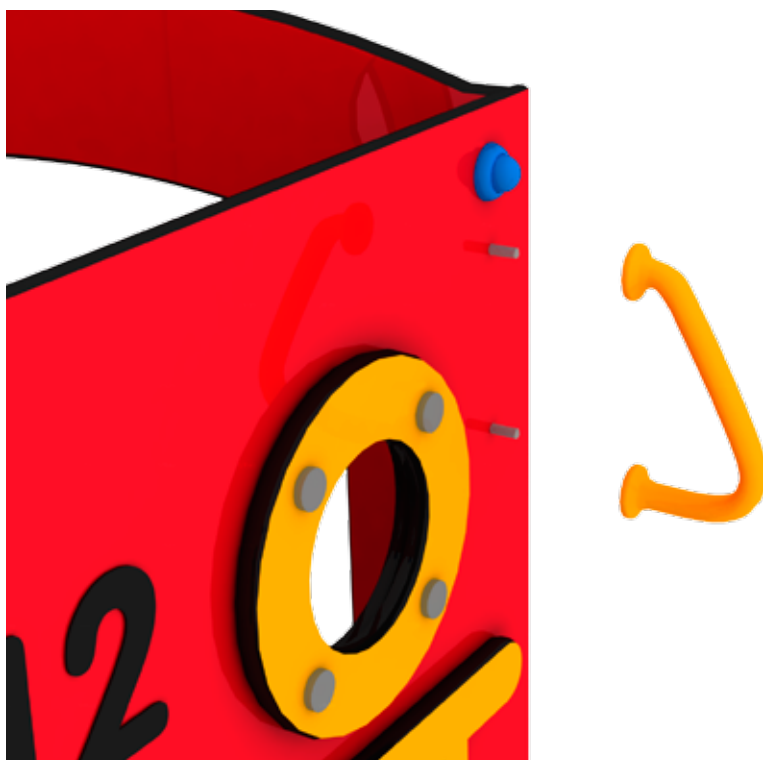
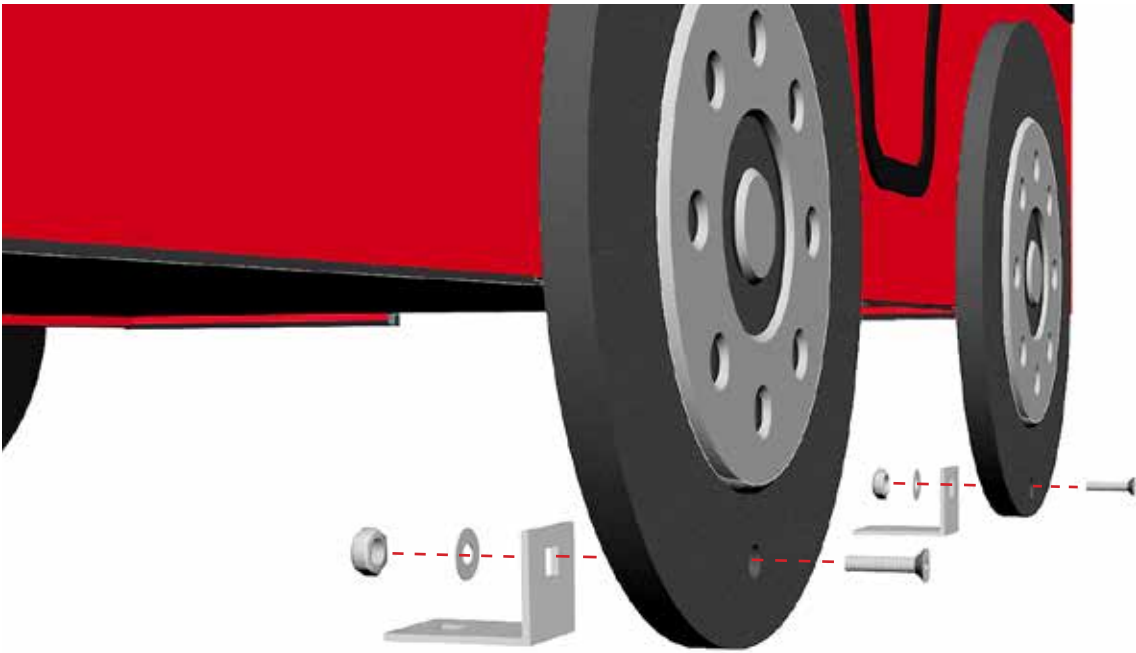

Finish • Finish • Finish 1 • Fin du montage • Finalizar

