

Mounting instructions for water play „aqua“

Item No. 511510401



Diagram 1: Overall view of the play equipment

Mounting instructions for water play „aqua“

Item No. 511510401

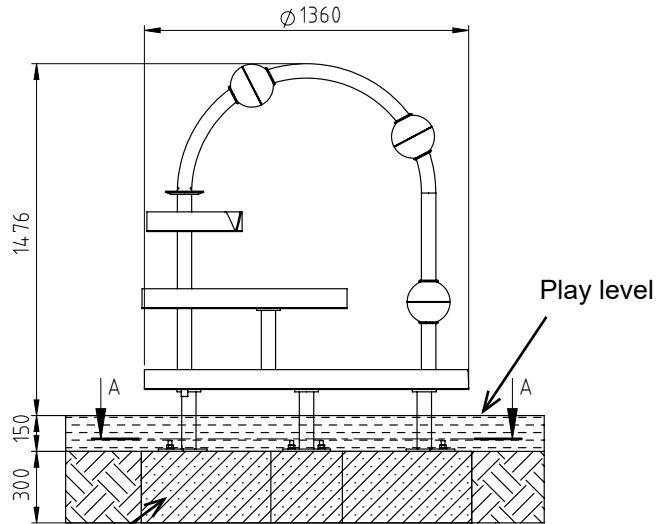

Concrete foundation

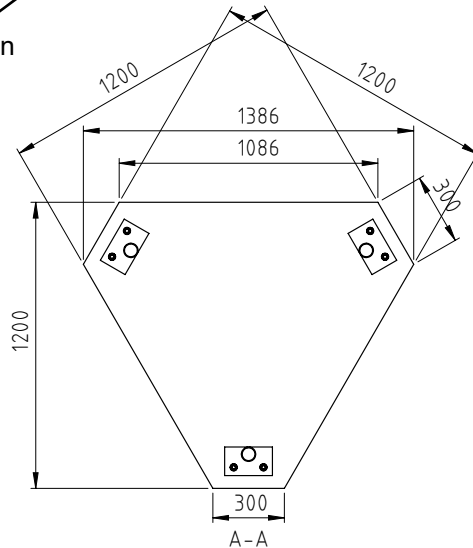

Legende





-  stoßdämpfender Boden
shock-absorbing floor
-  beliebiger Boden
optional floor
-  Beton
concrete
-  gewachsenes Erdreich
natural ground

Diagram 2: Foundation plan

1. **Note:** It is possible to play the play equipment „aqua“ with water or sand. The customer has to care for the water supply, the implementing and the maintenance. The play equipment „aqua“ must not be used in a closed water circulation.
2. Select the location of the play equipment taking into account the required minimum space (see diagram 3).
3. Carry out excavation work for the foundation as shown in diagram 2. After excavation compress the foundation floor.
Note: The water play is installed at play level. Pay attention to items marked „play level“ of play equipment!

Reinforcement plan: Concrete foundation with reinforcement

Main foundation: BSt 500S

Stirrups Ø 8 mm lengthwise and cross

Concrete cover $h' = 3$ cm

Concrete quality class C 20/25 - C 25/30

4. Set up the concrete foundation acc. to diagram 2 with central, horizontal reinforcement.
5. After a setting period of 10 - 14 days, depending on weather conditions and foundation size, fill up and compress the holes between foundation and the foundation hole with excavation.
6. Clean the foundation surface and place the play equipment on it. Screw the play equipment onto the foundation using the included heavy-duty dowels.
7. Create topsoil over the area of the minimum space.
Recommended surface material: optional
Note: The ground should be smooth and free of edges.
8. Do not allow children to use the equipment before the installation has been finished.

Mounting instructions for water play „aqua“

Item No. 511510401

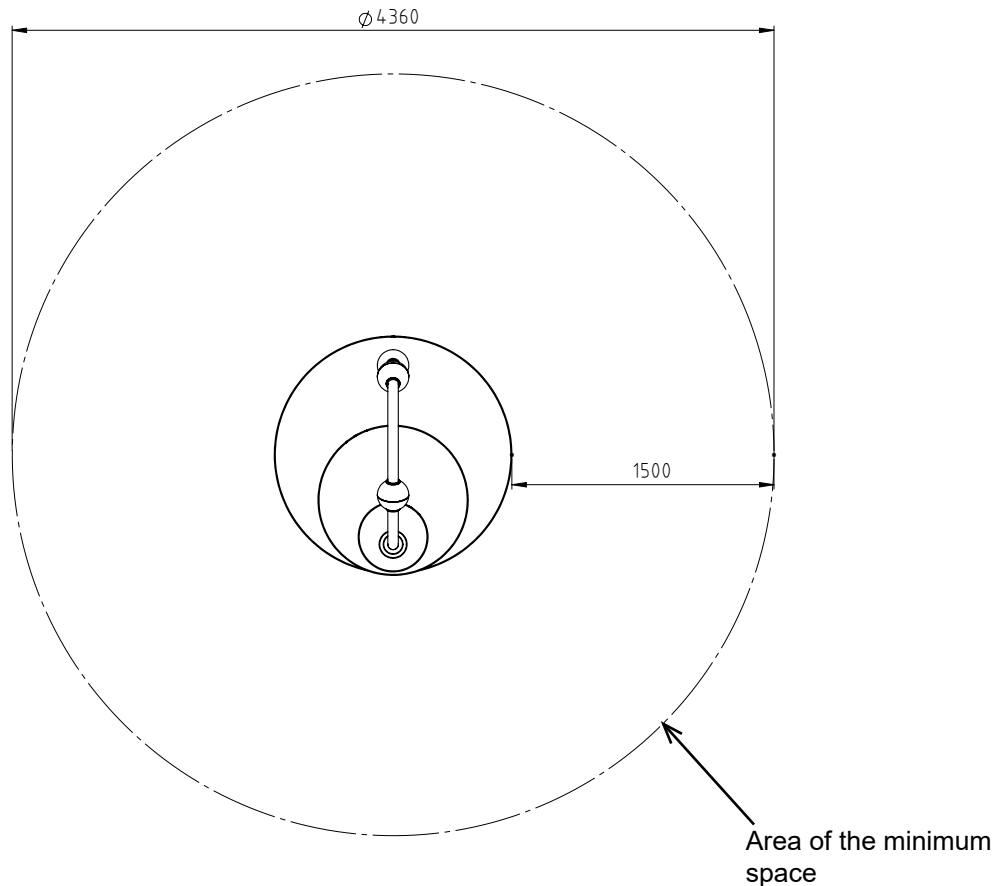

Diagram 3: Top view

Attention: If the play equipment has been incompletely installed or partly dismantled when carrying out maintenance and repair work, this may lead to particular risks of injury for the user. For this reason, make clearly visible that the equipment shall not be used in such cases.

NOTE: Play equipment, which contain components made of stainless steel should not come with „normal“ steel parts in contact. Those steel parts may rub off and leave small steel particles in combination with moisture brown rust stains. If such corrosion occur on stainless steel parts, they are fine with an abrasive (240 grit) to remove.

Please take care when transporting and setting up the fact that the components are made of stainless steel with no „normal“ steel parts in contact.

In order to preserve a good visual appearance of your stilum playground equipment over a long period one should take care of maintenance of the stainless surface even despite of their corrosion resistance.

Especially areas, which can not be reached by rainfall should be frequently cleaned from dirt and deposits due to air pollution and dirt caused by the atmosphere. Light soiling can easily be removed by using a high pressure cleaner.

For persistent deposits use a clean cloth moistened with a special liquid cleaner (e.g. on phosphoric acid) and rinse off with clear water after a short application time. During cleaning with mild abrasive components, only wipe over stainless steel surface in polishing direction.

For heavily soiled surfaces, polishes can be used (e.g. for cleaning chrome on cars) or for greasy and oily dirt alcoholic cleaning agents and solvents (e.g. ethyl alcohol, isopropyl alcohol or acetone).

However, it should be noted that the dissolved soiling is not spread over the surface again.

Do not use any chlorid or hydrochloric containing cleaning products nor scouring powder, bleaching - or silver polish cleaner. Cleaning intervals depend on type and degree of soiling as well as on demands made on optical characteristics.

Therefore cleaning is advisable at intervals of six to twelve months – whereby in the case of strong soiling it is appropriate to clean the playground equipment at intervals of three to six months.