

product line **EXTRA**

LIGHTHOUSE 1

with tube



Product is offered either with fiberglass or stainless steel tube Ø460mm

PRODUCT COMPOSITION

SBR+EPDM rubber granules, aliphatic PU binder, vandal-resistant fiberglass shell, PU climbing holds, stainless steel (opt. fiberglass) tube

COLOR COMBINATION

standard: white, rose (other combination on request)

COLOR STABILITY

UV stable

RECOMMENDED SAFETY SURFACE

safety rubber surface in the area of 1930mm around the product (according to EN1177)

PRODUCT SAFETY

certified according to EN1176
complies with ASTM F1487 and CAN/CSA Z614

INSTALLATION

the product is installed onto a concrete foundation

PACKAGING





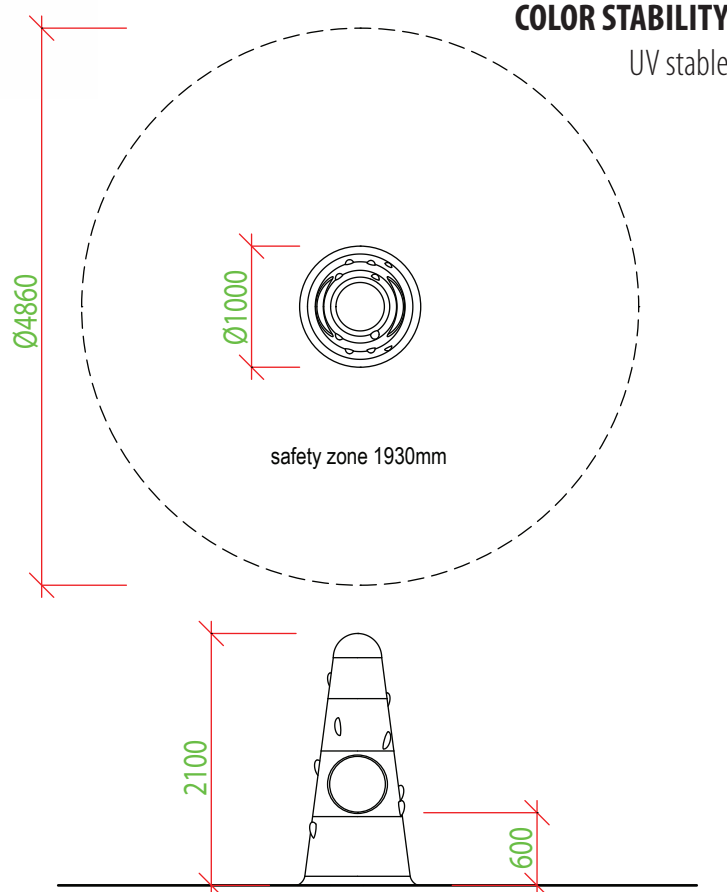

wrapped in plastic and delivered on a pallet 1200 x 1200mm

STORAGE

in original packaging on a pallet
in temperatures between - 40° C and 50° C



Our products are handmade, please allow dimensional tolerance up to 40 mm

 110 kg weight	 2100 mm critical fall height	 2 h assembly time	 4 - 14 yrs users' age	 3 max. number of users	 Ø 1000 mm h=2100 mm dimensions
--	--	---	---	--	--

3D PROGRAM, s.r.o.

Objízdná 1911
765 02 Otrokovice
Czech Republic



MADE IN EU

www.3dprogram.eu
info@3dprogram.eu
+420 602 500 045 +420 577 700 718

