

PL	INSTRUKCJA MONTAŻU	Nazwa	Tablica Milo Kwiatek	Nr kat.	3680
ENG	ASSEMBLY INSTRUCTIONS	Product	Milo Flower Board	Cat. no.	
DEU	MONTAGEANLEITUNG	Name		Art.-Nr.	

3680



Wiek użytkowników Age of users Altersgruppe	Ilość użytkowników Number of users Anzahl der Benutzer	Przeznaczenie urządzenia Purpose of device Bestimmung des Spielgerätes	Zgodność z normą In accordance with the standard Geltende Norm
1-6	2	do zabawy na zewnątrz for outdoor playing zum draußen Spielen	PN-EN 1176-1:2017
NOVUM Sp. z o.o. ul. Gnieźnińska 2a, 12-100 Szczytno		e-mail: kontakt@novum4kids.pl e-mail: export@novum4kids.com	www.novum4kids.pl www.novum4kids.com

UWAGA / WARNING / ACHTUNG:

PL Jeżeli w zestawie występuje zjeżdżalnia, zestaw należy posadowić w taki sposób, aby ślizg zjeżdżalni znajdował się od strony północnej, czyli od strony nienasłonecznionej, aby zapobiegać nadmiernemu nagrzewaniu się ślizgu.

ENG If there is a slide in the set, it should be installed from the north, poorly sunny side to avoid possible hazards (burns) through direct skin contact.

DEU Wenn eine Spielplatzanlage eine Rutsche enthält, sollte diese Anlage so platziert werden, dass die Rutsche sich auf der Nordseite befindet, dh. auf der schattigen Seite, um übermäßige Erwärmung der Rutschbahn zu vermeiden.

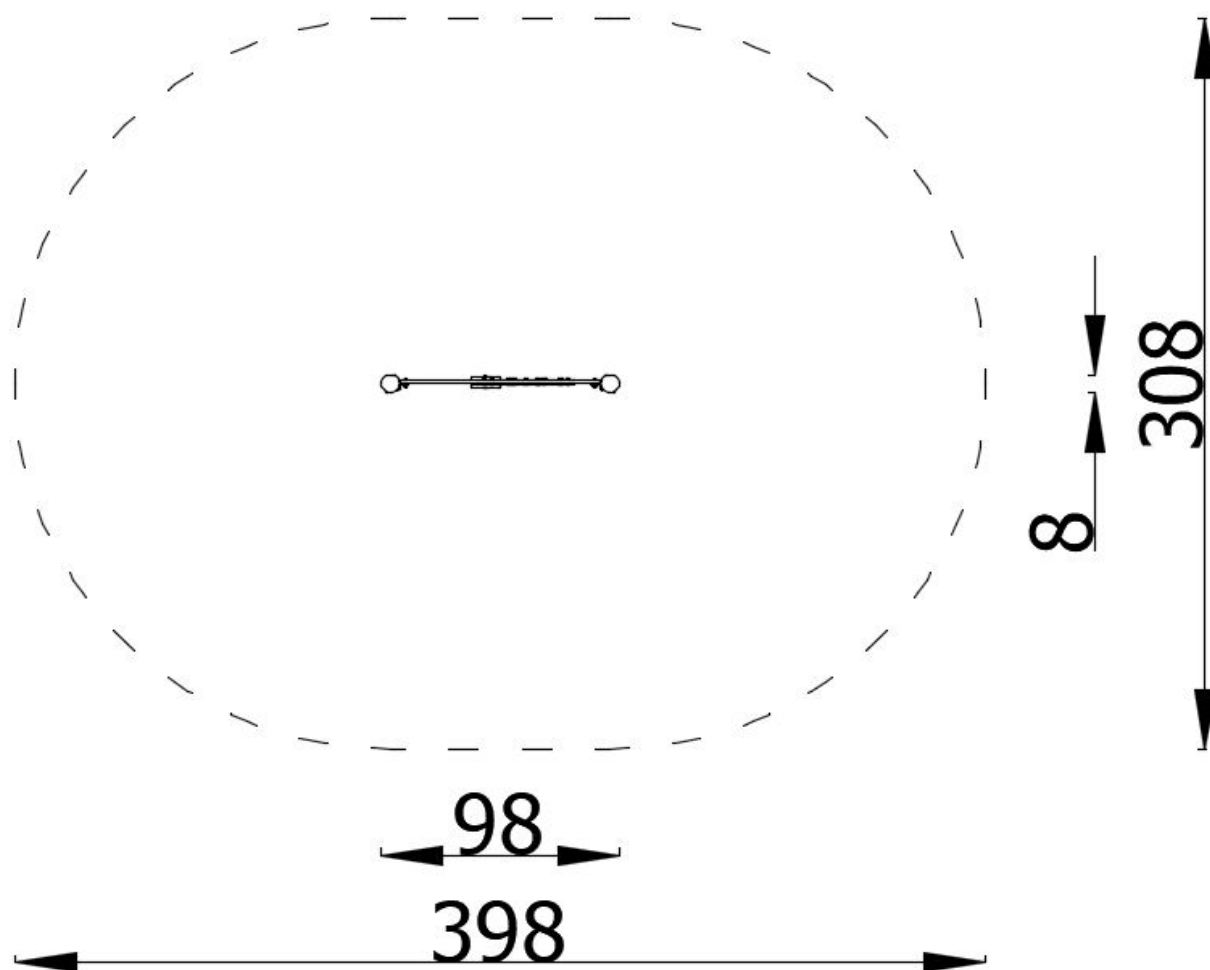

Montaż zgodnie z planem zagospodarowania terenu.
 Installation in accordance with the land development plan.
 Montage gemäß dem Flächennutzungsplan

Bezpieczna nawierzchnia / Safe surface / Safe Oberfläche

Strefa Zone Zone	Max. wysokość upadku Max. fall height Max. Fallhöhe	Pole powierzchni Surface area Fläche	Obwód strefy bezpiecz. Perimeter security zone Umkreis der Fallschutzfläche
A	0,00 m	10,50 m ²	12,00 m
B	-	-	
C	-	-	

Nawierzchnia / Safe surface / Fallschutzbelag

3680

	Materiał Material Material	Min. wysokość warstwy Min. layer thicknesses Min. Schichtöhe	
h<0,6 m	Beton / Concrete / Beton Nawierzchnia bitumiczna / Bituminous surfacing / Bituminöse Oberfläche		
h≤1 m	Gleba / Topsoil / Boden Darń / Turf / Grasnarbe		
h≤2 m	Kora / Bark / Borke	20÷80 mm	300
	Wióry / Wood chips / Holzhackschnitzel	5÷30 mm	
	Piasek / Sand / Sand Żwir / Gravel / Kies	0,25÷8 mm	
h≤3 m	Kora / Bark / Borke	20÷80 mm	400
	Wióry / Wood chips / Holzhackschnitzel	5÷30 mm	
	Piasek / Sand / Sand Żwir / Gravel / Kies	0,25÷8 mm	
h≤3 m	Nawierzchnia syntetyczna / Synthetic granulates / Synthetische Oberfläche	wg danych producenta acc. to the manufacturer's data nach Angaben des Herstellers	

Posadowienie / Foundation / Gründung

3680

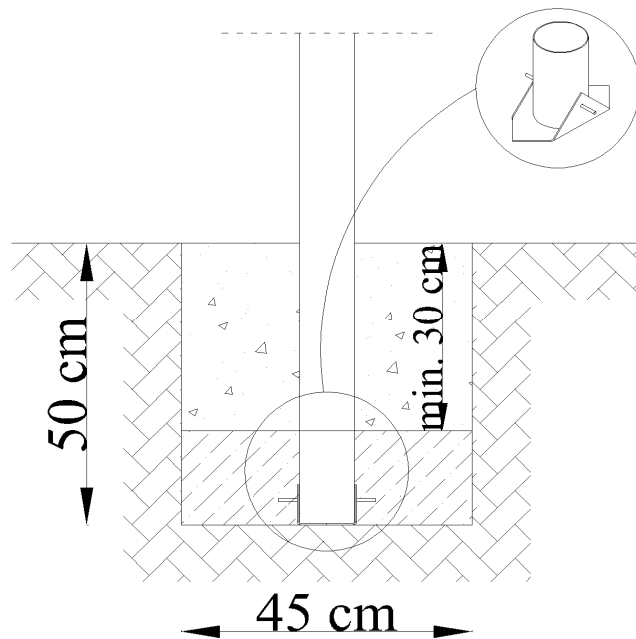

Beton / Concrete / Beton: **C16/20** - **0,06 m³**

W celu kontroli fundamentów należy usunąć nawierzchnię bezpieczną / piasek / żwir etc.
 In order to control the foundations, remove the safe surface (sand, gravel, etc.)
 Um die Fundamente zu überprüfen, entfernen Sie den Fallschutzbelag: Sand/ Kies etc.

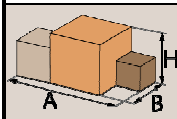
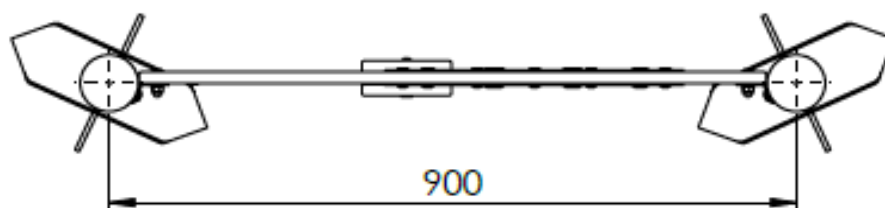
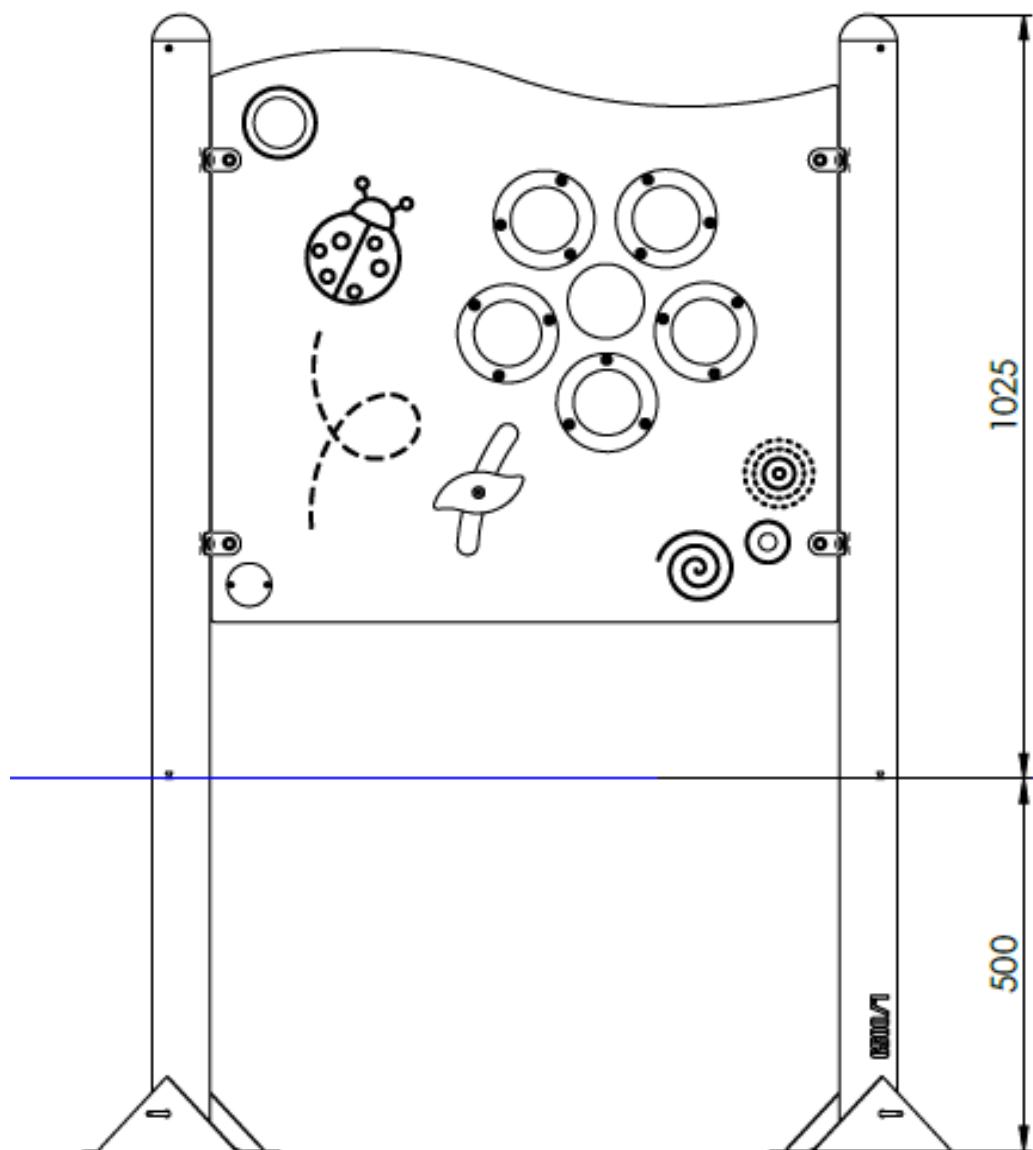

0,98x0,08x1,03
(AxBxH) [m]



23 kg

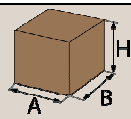

0,2x0,2x1,6
(AxBxH) [m]



9,8 kg

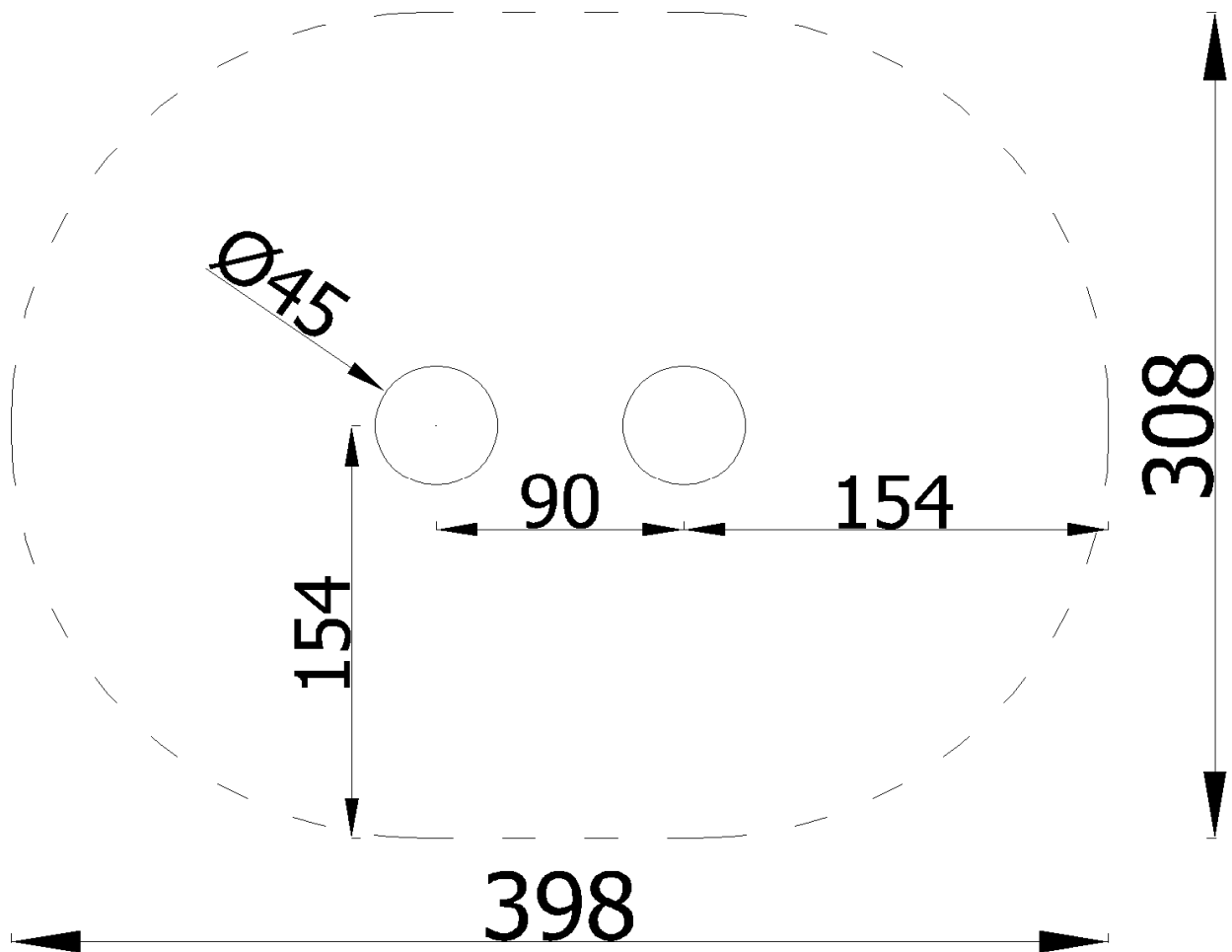

1. Skręcić panel ze słupami.
2. Umieścić tablicę w wykopkach i zabetonować.
3. Z urządzenia można korzystać min. 28 dni po zabetonowaniu.

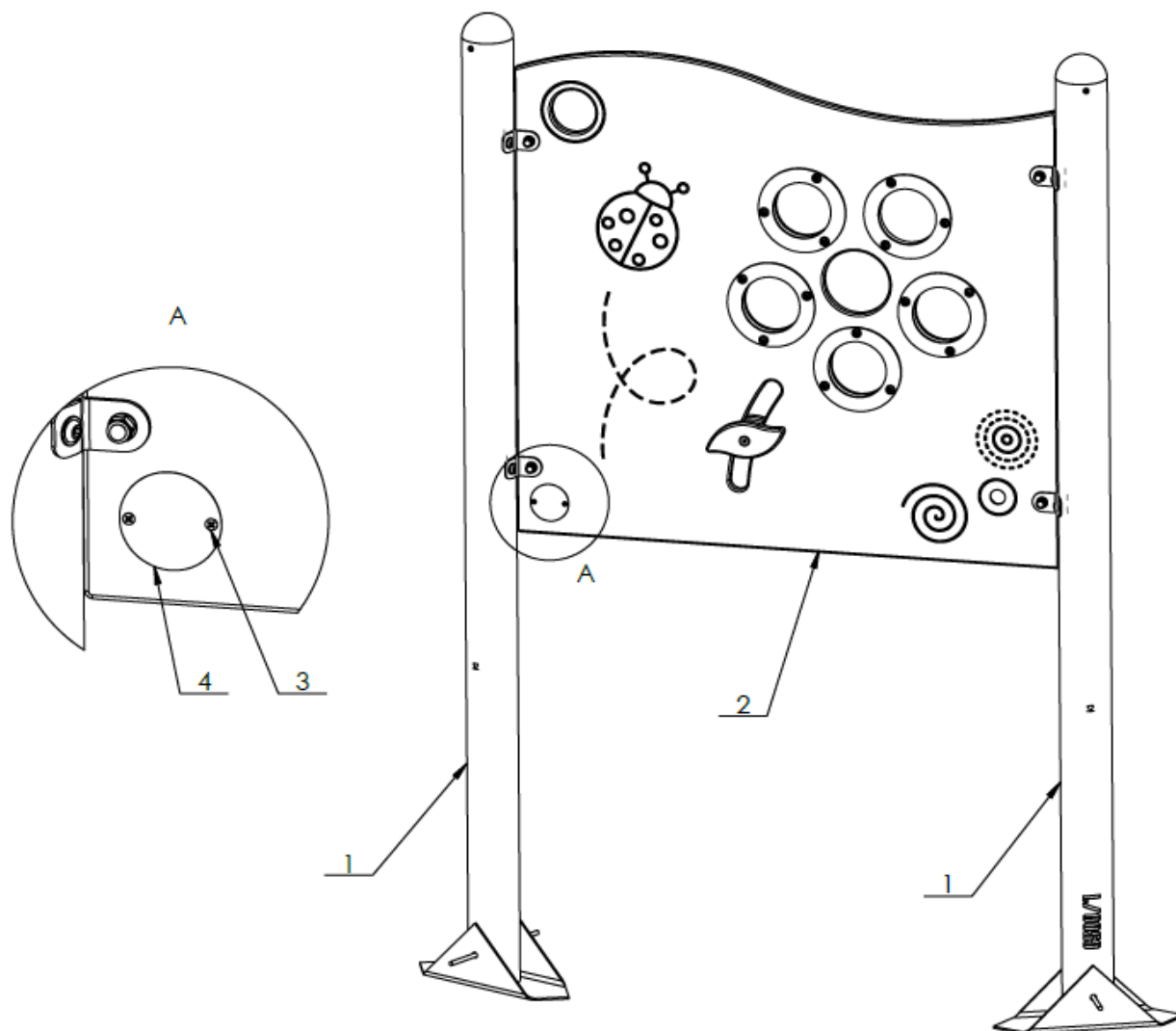



Części zamienne dostępne u producenta.
Stosować klej do gwintów w połączeniach śrubowych.

Spare parts available from the manufacturer.
Use thread glue in screw connections.

Ersatzteile beim Hersteller erhältlich.
Gewindekleber für Schraubverbindungen verwenden.

4	8918_006	1
3	DIN7997_3,5x12_A2	2
2	69402	1
1	6500_001	2
Lp. No.	Nr części Art. Nr. Part No.	Ilość Quantity Anzahl

															
								5 m	30 m						
															
2,5 m				60 cm	100 cm										
															
				7 mm								13 mm	17 mm	19 mm	24 mm
															
13 mm	17 mm	19 mm	24 mm	4 mm	5 mm	6 mm	8 mm	T40				T45			
															

ISO7089_8_A2	4
DIN986_M8_A2	4
ISO7380_2_M8x16_A2	4
ISO7380_2_M8x30_A2	4
B_69000_002	4
69402_001	1
Drawing/Norm	Quantity

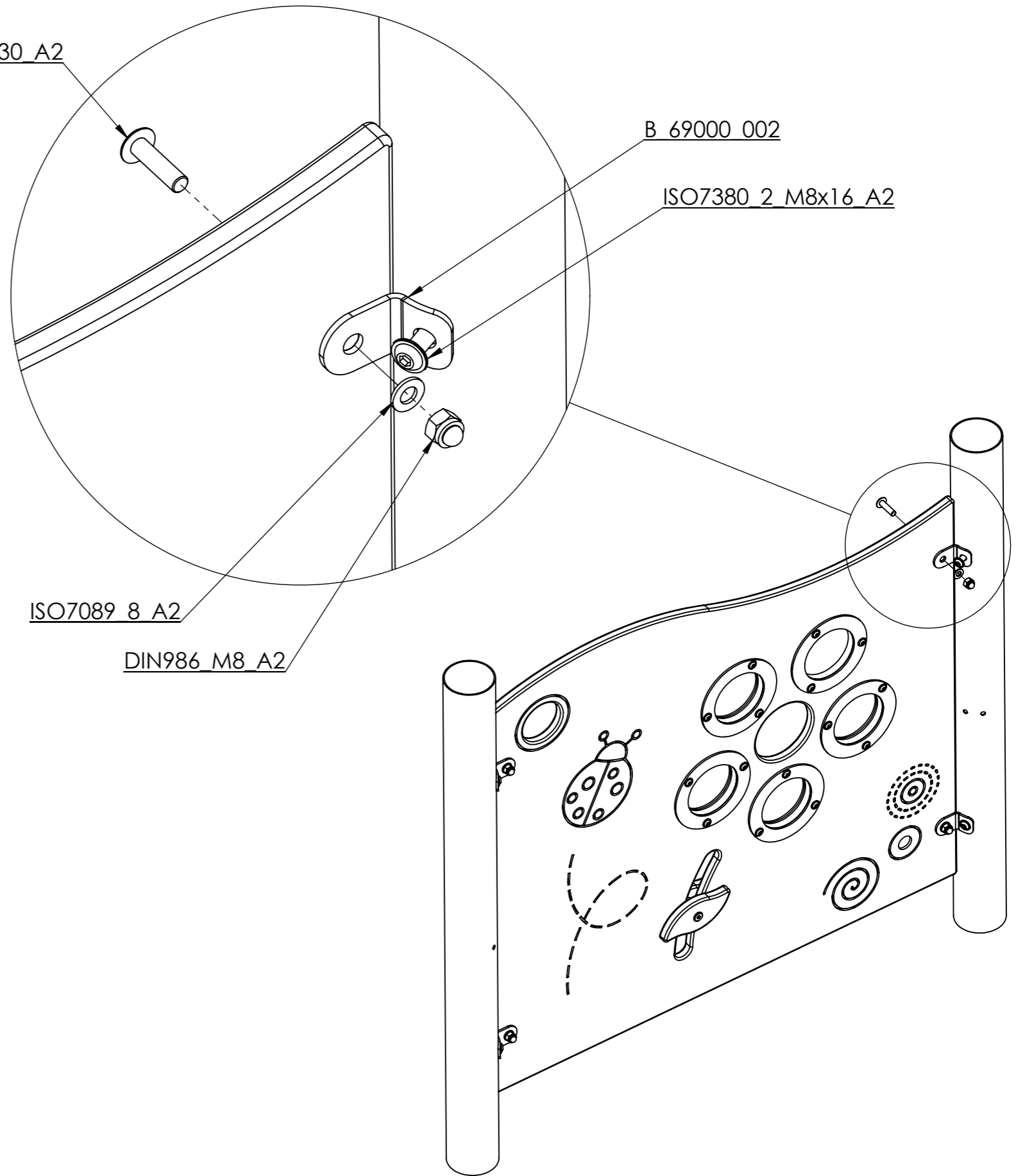
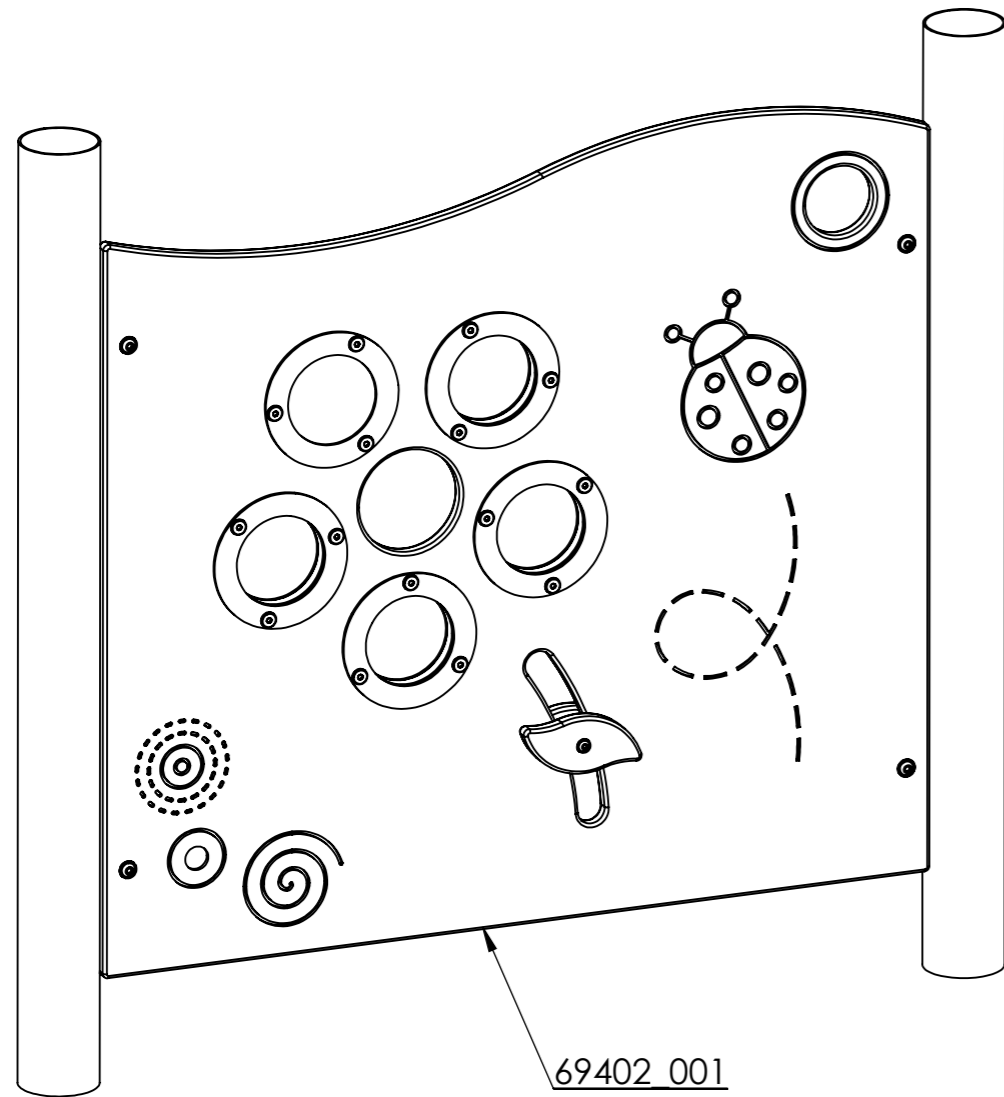

8905_503_A2	2
8912_118	1
8850_002	1
B_8802_026	1
R_6500_001	1
Drawing/Norm number	Quantity

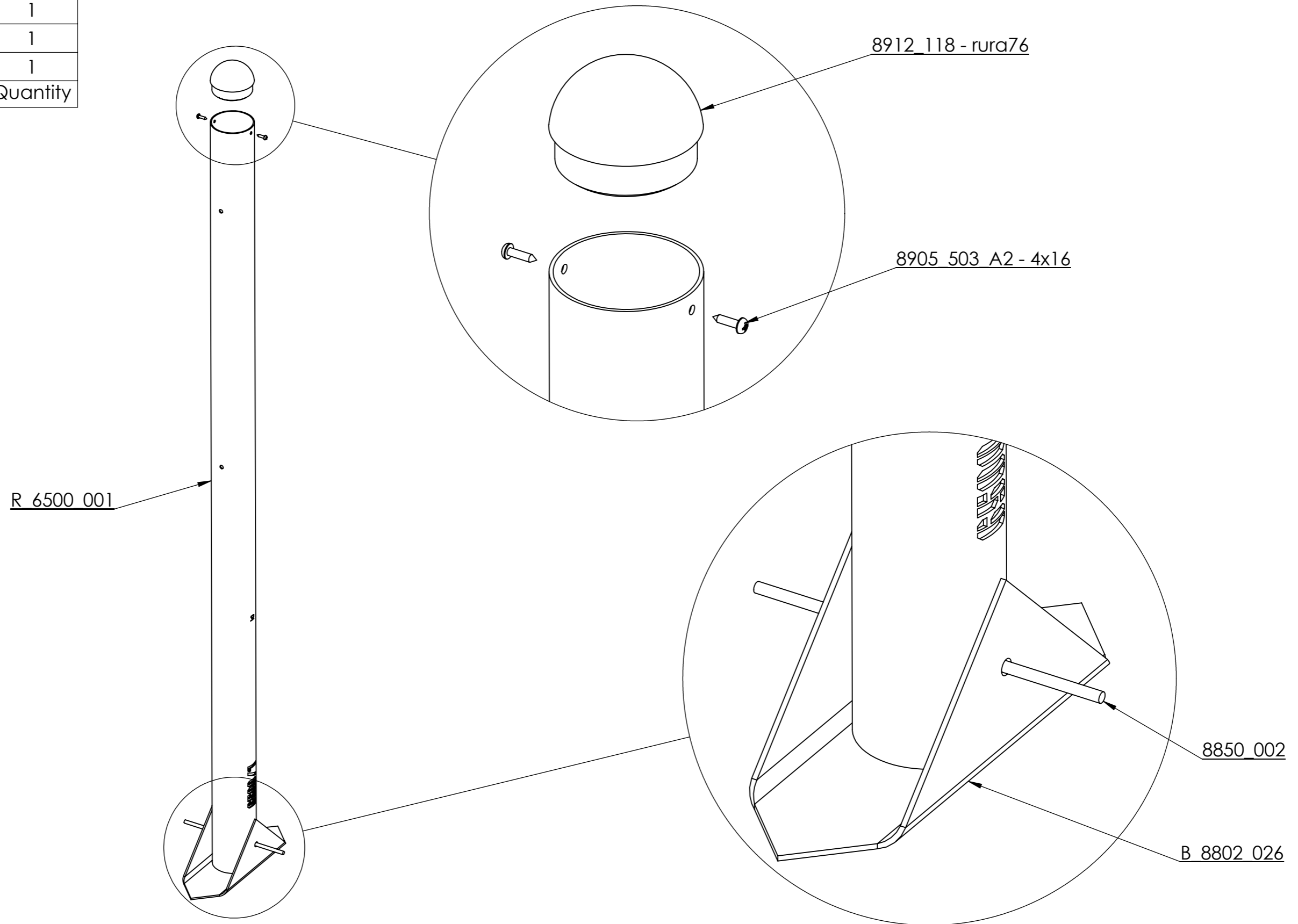

Cat. no.
6500_001