

642090

Multi-seesaw, Galionen

Assembly instructions • Montageanleitung • Montagevejledning



100 cm



1 - 12



2



7 H



312 x 115 x 100 cm

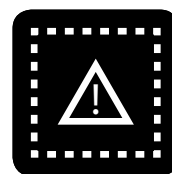

512 x 315 cm

Ⓚ	Gode råd og vink	3
	Pladshensyn og faldunderlag	4
	Komponentorientering	5
	Gravedybde	6
	Fjeder montage	7
	Vippe montage	8
	Finish.	14
Ⓜ	Some good advice and tips	3
	Clearance and safety surfaces	4
	Components overview	5
	Digging depth	6
	Spring assembly	7
	Seesaw assembly	8
	Finish.	14
Ⓓ	Ein paar gute Ratschläge und Tipps	3
	Platzbedarf und Fallschutzunterlage	4
	Bauteileübersicht	5
	Grabtiefe	6
	Feder montage	7
	Vippe montage 3	8
	Finish.	14

- ⒹⓀ 1. Tag komponenterne af pallen og læg dem på jorden
2. Check efter komponentlisten om alle er med
3. Vær omhyggelig med afstande generelt
4. Pak én komponent ud af gangen og gør denne færdig
5. Vær omhyggelig med brug af vatterpas
6. Faldunderlag etableres til allersidst sammen med påsætning af mærkning med producent

ⒹⓅ Some good advice and tips

1. Take all components from the pallet and place them on the ground
2. Compare with components list – is everything there?
3. Be at all times precise when measuring
4. Unpack one component at a time and assemble it
5. Usage of a water-level will increase precision
6. Fall protection is the very last thing to be installed – along with the producer's label

Ⓓⓔ Ein paar gute Ratschläge und Tipps

1. Alle Bauteile von der Palette nehmen und auf den Boden legen.
2. Anhand der Bauteileliste überprüfen, ob alle Teile vorhanden sind
3. Beim Abmessen generell präzise arbeiten
4. Ein Bauteil nach dem anderen auspacken und montieren
5. Die Benutzung einer Wasserwaage erleichtert die Montage
6. Die Fallschutzunterlage wird erst ganz zum Schluss verlegt – dann, wenn das Produzentenetikett angebracht wird

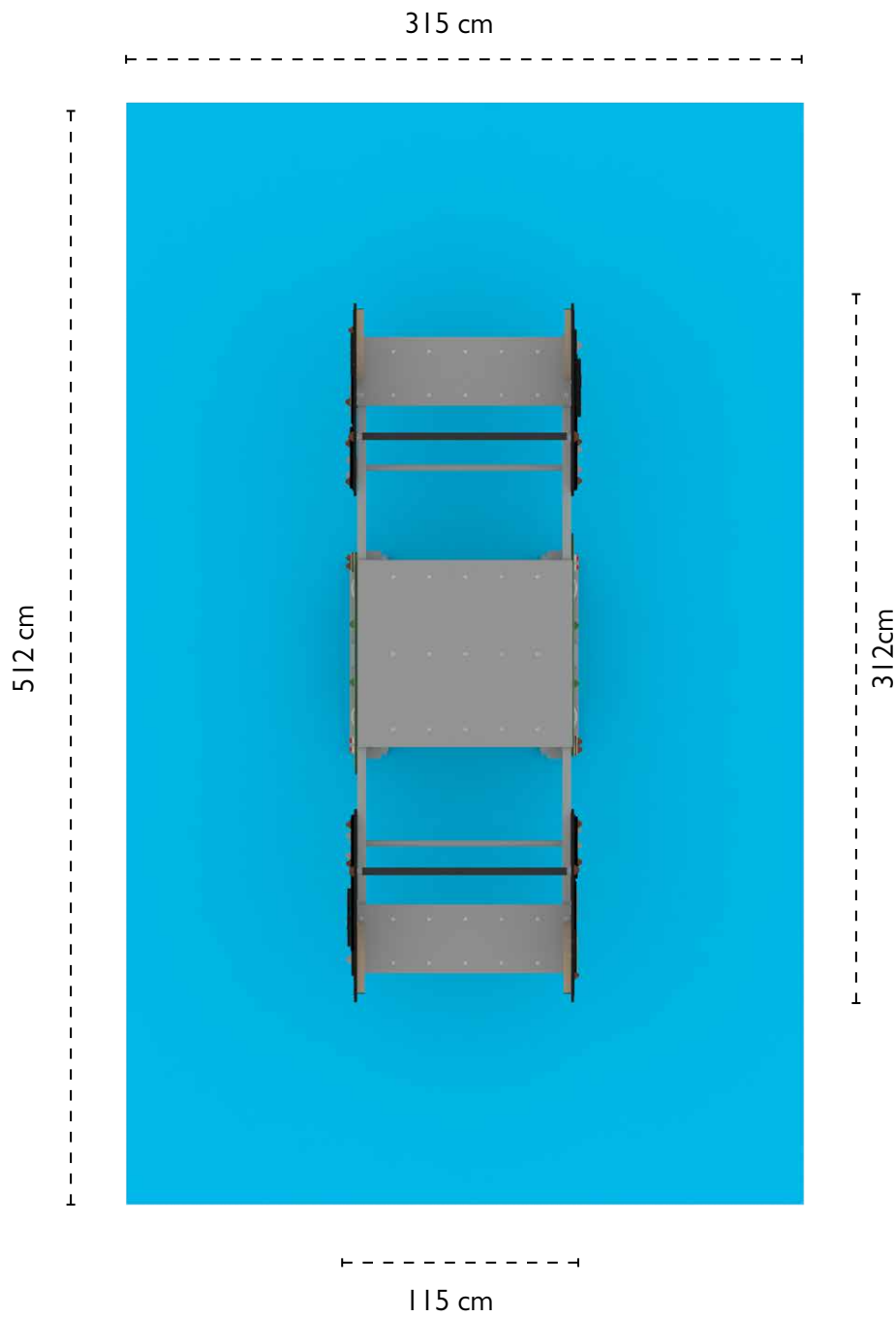

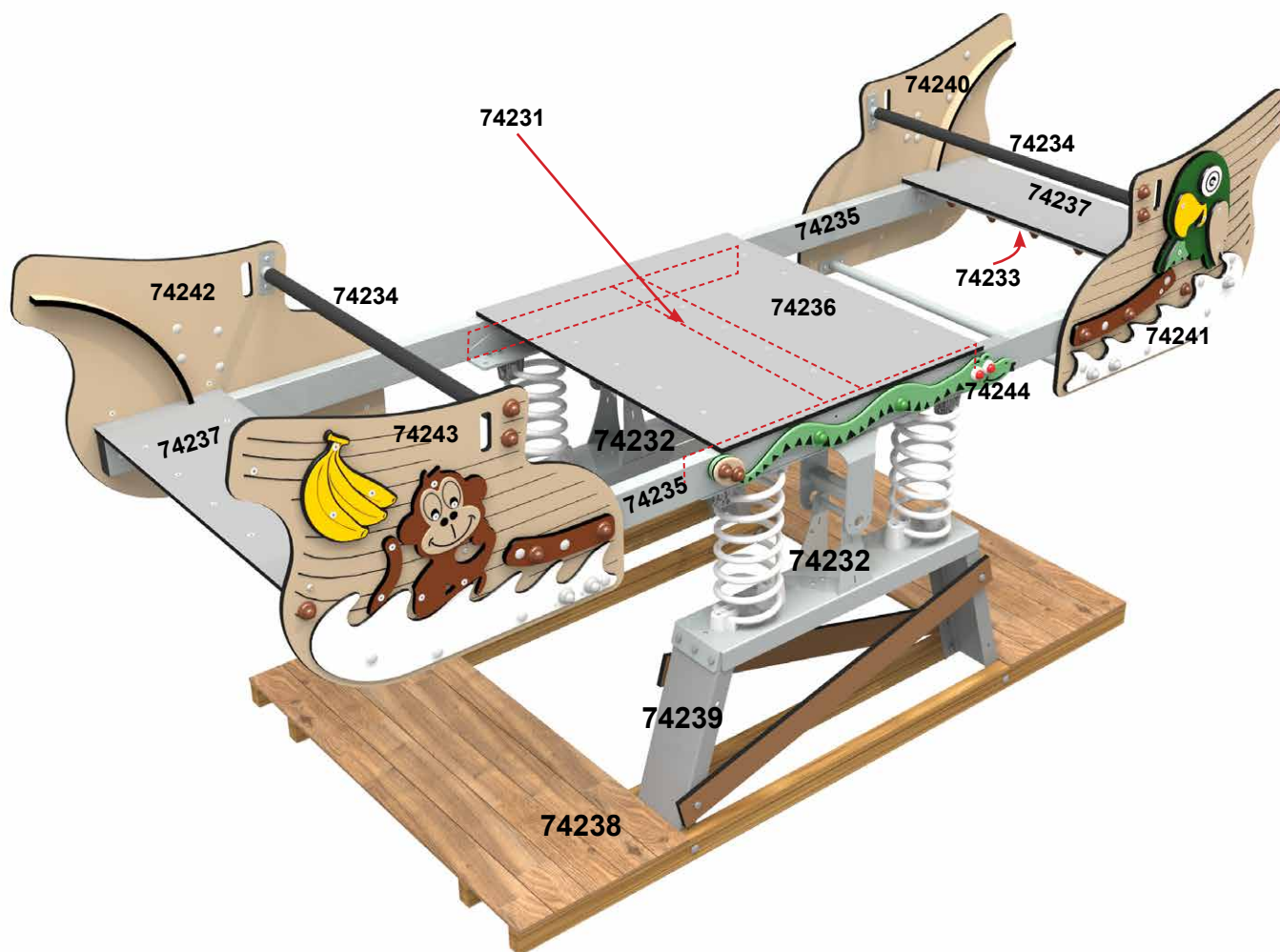

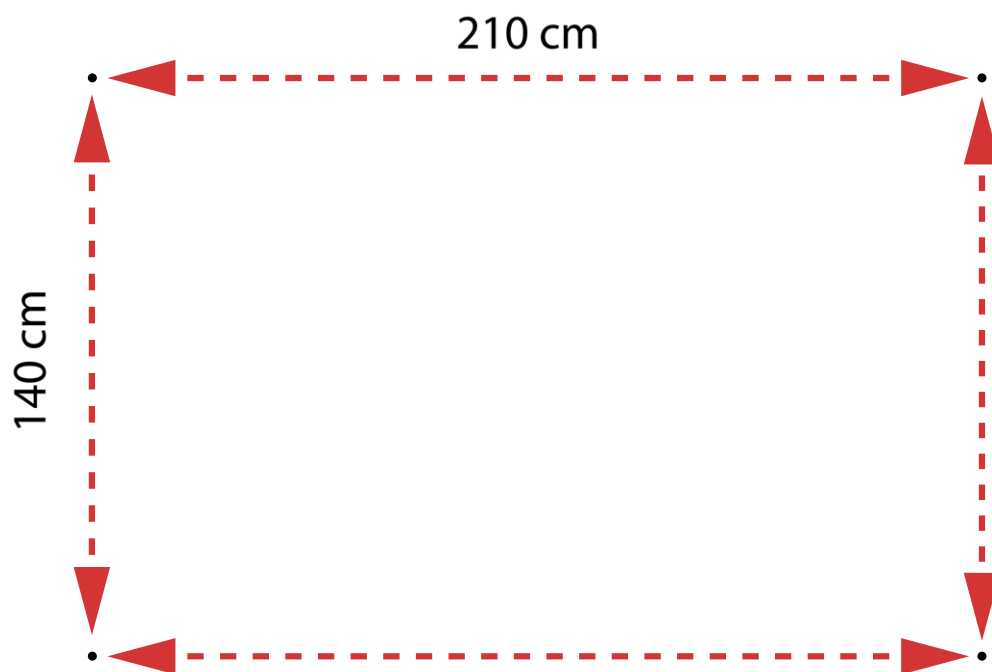
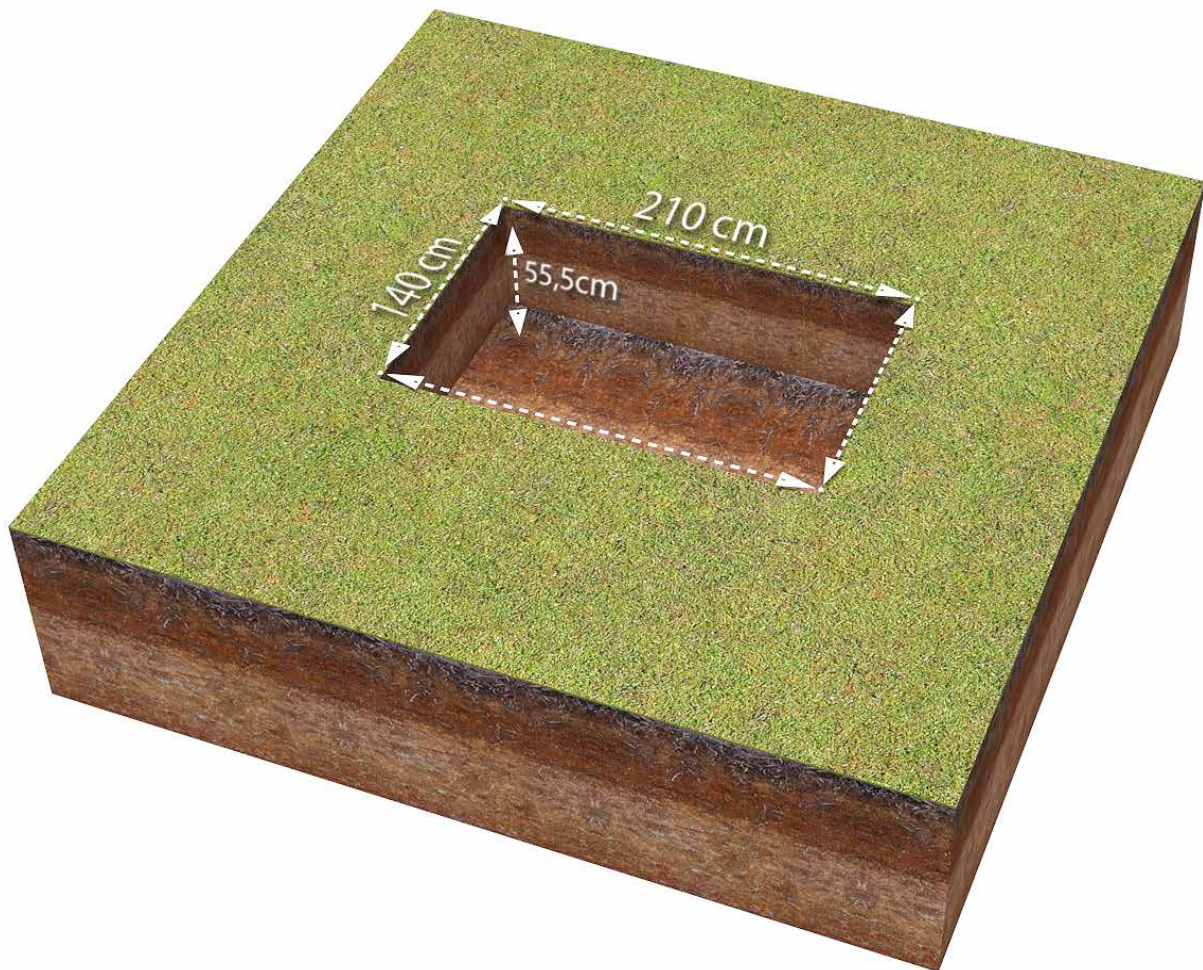

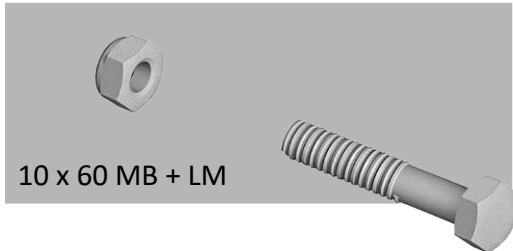
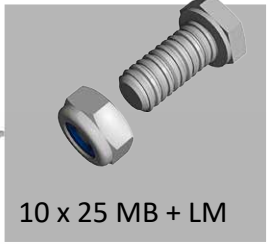
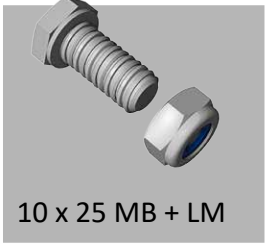
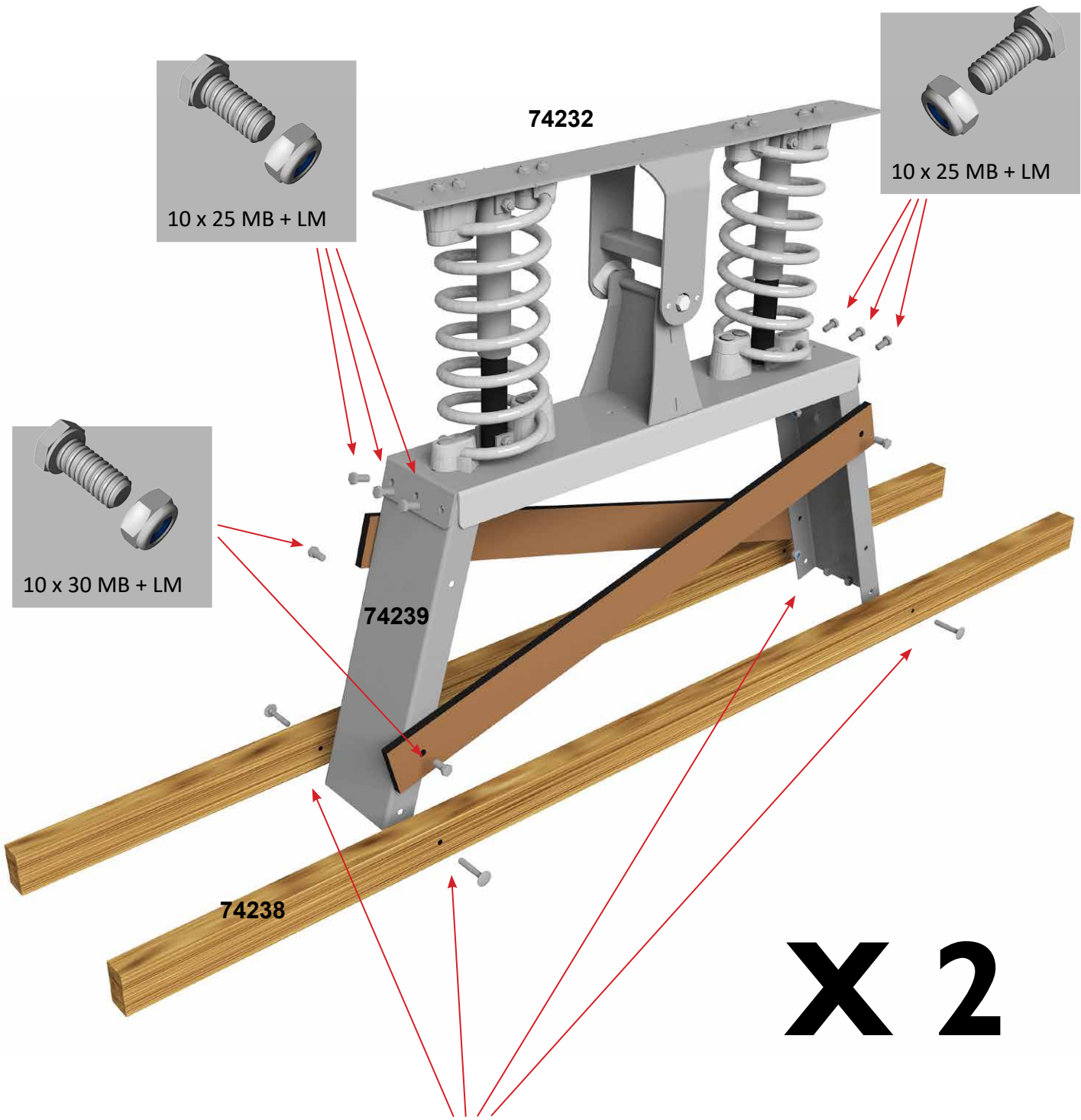

X 2

