

LEDON®

No. 435 - Foal

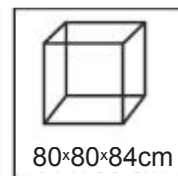

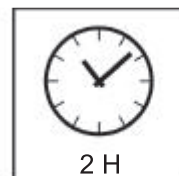

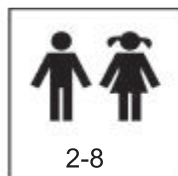
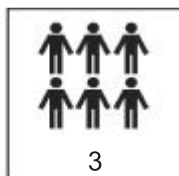
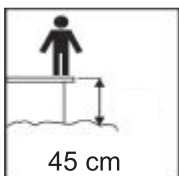
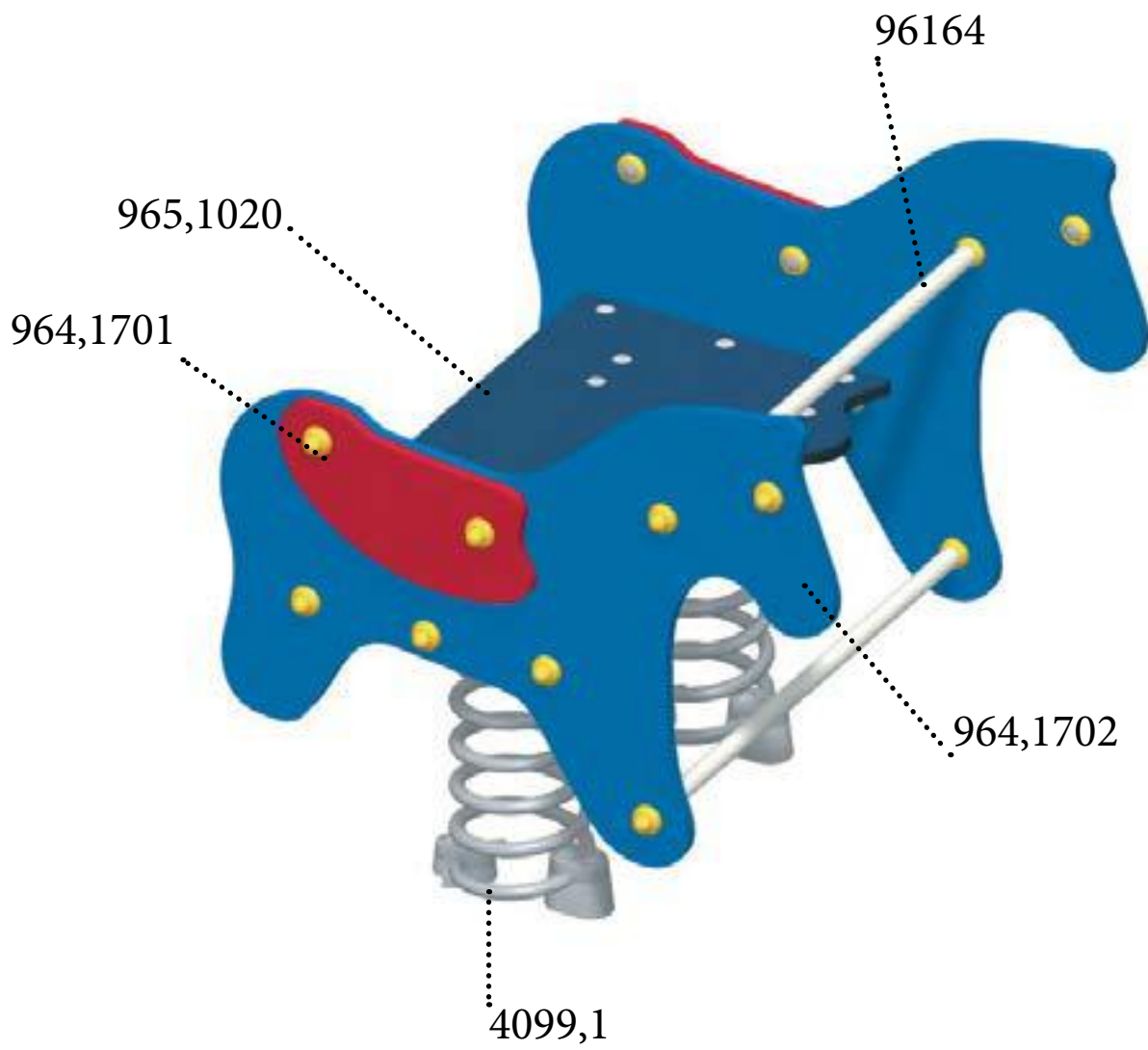

Faldunderlag: I overensstemmelse med EN 1177

Safety surface: In accordance with EN 1177

Fallschutzbelag: Gemäß EN 1177







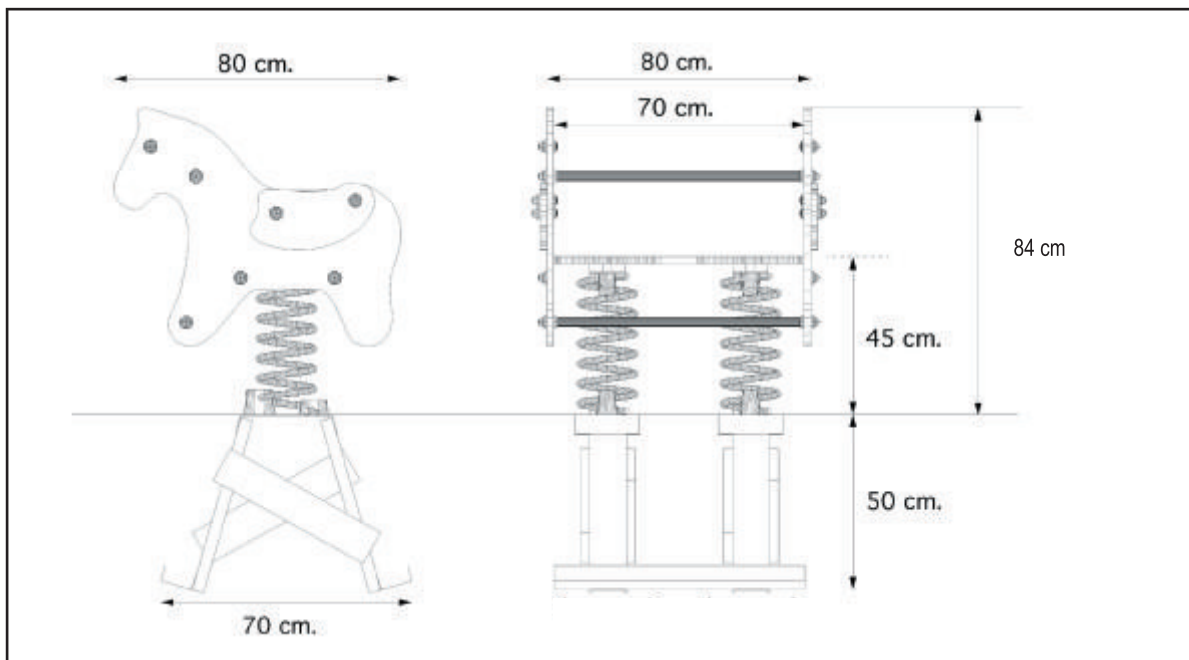
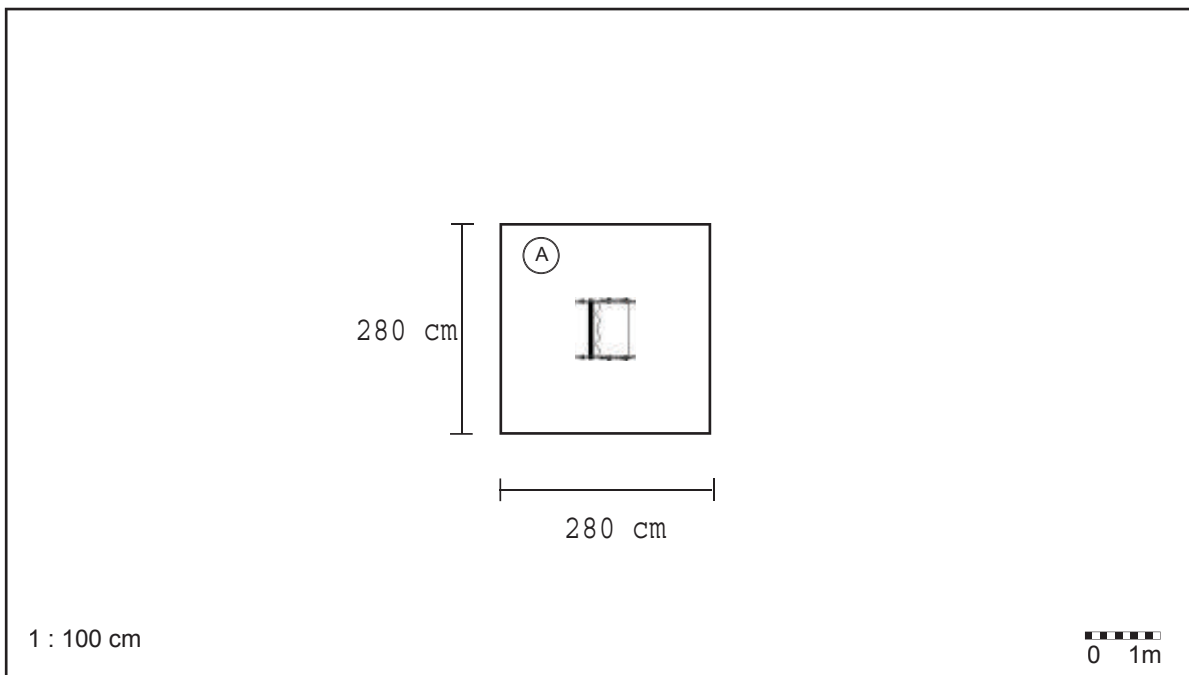

Zone D'impact d'après norme EN 1177

Fundamento de caída según norma EN 1177

		
(A)	45 cm	7,84 m2





4 Pcs.		10x40 MB
8 Pcs.		GT
8 Pcs.		10 x 110 MB
2 Pcs.		70 x 9 x 4,2 cm
2 Pcs.		41 x 4 x 1,5 cm
4 Pcs.		LM 6
4 Pcs.		M6x16 Pin TX 30
1 Pcs.		TK 30
4 Pcs.	