

—— EN Impact Area 6.3 m<sup>2</sup>  
 - - - Falling Space 6.3 m<sup>2</sup>  
 Max Falling Height 600 mm

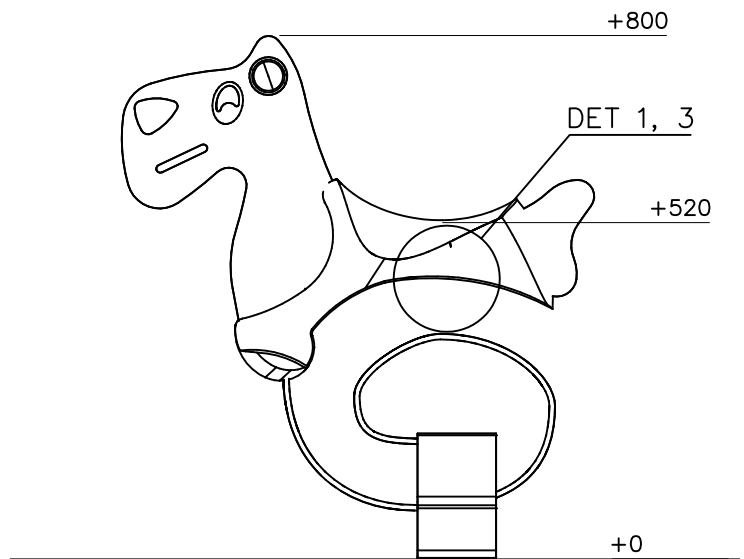

DET 1

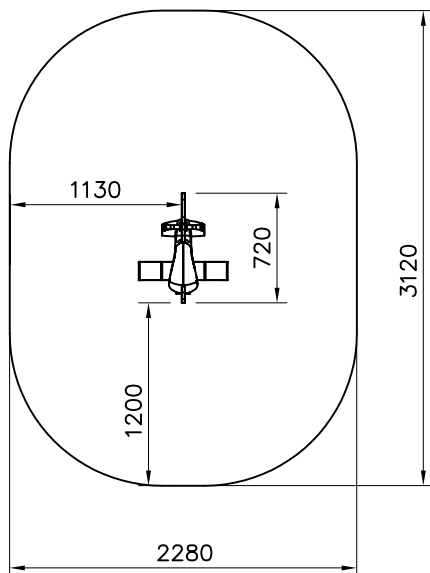
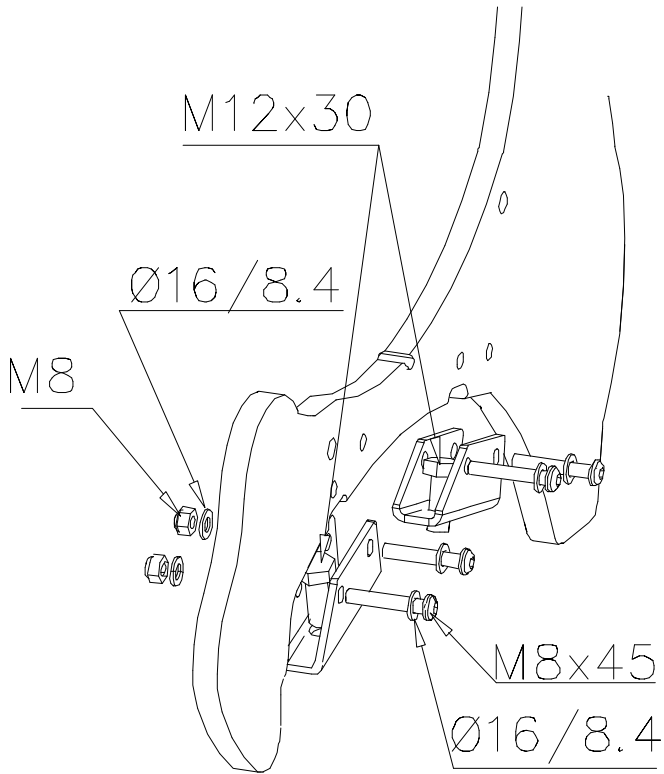

DET 2

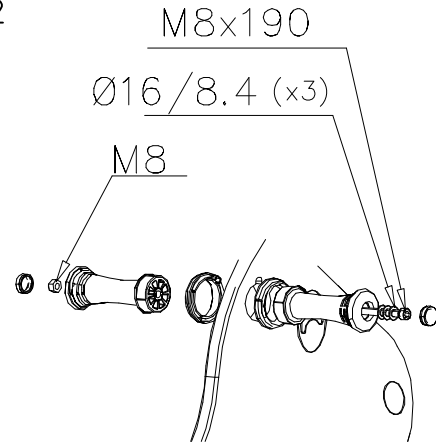

DET 3

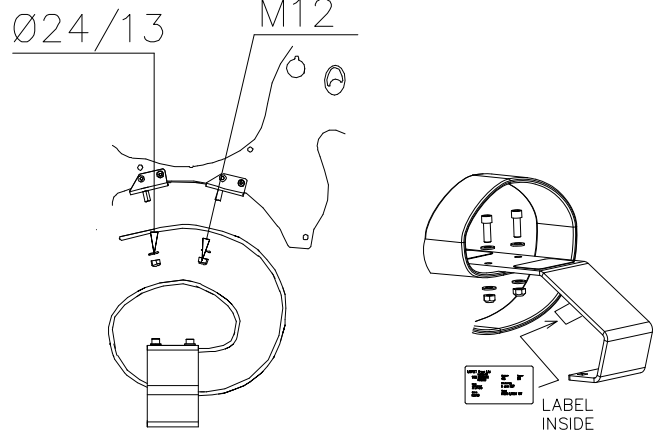



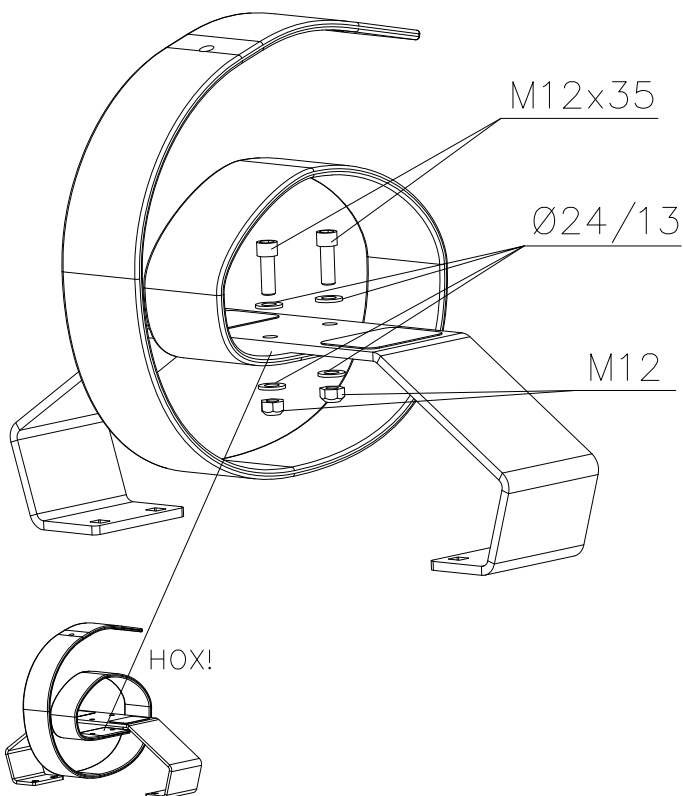



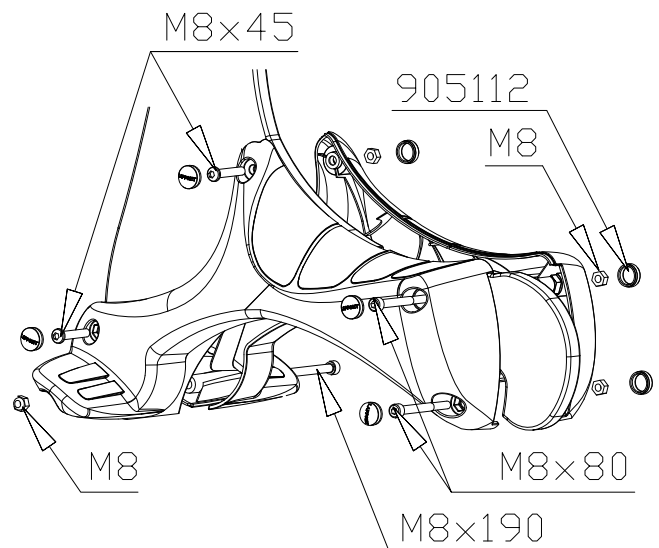

DET 4

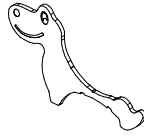
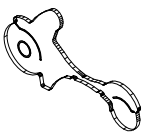
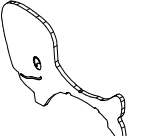

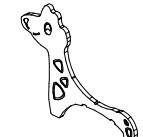
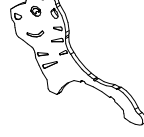
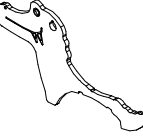

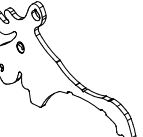
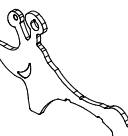







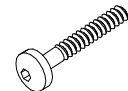

DET 5

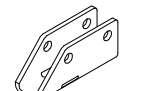
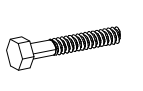
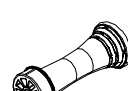

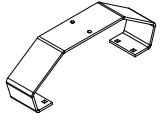
① 701988 (010501) 	PCS 1	① 701960 (010502) 	PCS 1	① 701991 (010503) 	PCS 1	① 702025 (010504) 	PCS 1	① 702023 (010505) 	PCS 1	① 702024 (010506) 	PCS 1
① 702028 (010507) 	PCS 1	① 702027 (010508) 	PCS 1	① 704435 (010509) 	PCS 1	① 704436 (010510) 	PCS 1	① 704437 (010511) 	PCS 1	① 706329 (010512) 	PCS 1
① 706331 (010513) 	PCS 1	① 707751 (010514) 	PCS 1	① 707571 (010516) 	PCS 1						

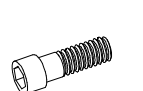
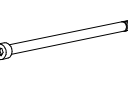
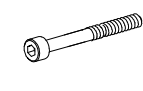
707014



② 901899  M8x45	PCS 6	③ 902095  RIGHT	PCS 1	④ 902133  LEFT	PCS 1	⑤ 902211 	PCS 2	⑥ 902303 	PCS 2	⑦ 903149  M12x30	PCS 2
⑧ 905023 	PCS 2	⑨ 905032  8,5x90	PCS 1	⑩ 905106  590x190x120	PCS 1	⑪ 905112  Ø22	PCS 10	⑫ 906511  M12	PCS 4	⑬ 909146  M12x35	PCS 2
⑭ 909195  M8x190	PCS 2	⑮ 909340  M8x80	PCS 2	⑯ 980150  M8	PCS 10	⑰ 980151  Ø16/8.4	PCS 11	⑱ 980154  Ø24/13	PCS 6		

⑲ 702286  90x50	PCS 1										
---	----------	--	--	--	--	--	--	--	--	--	--

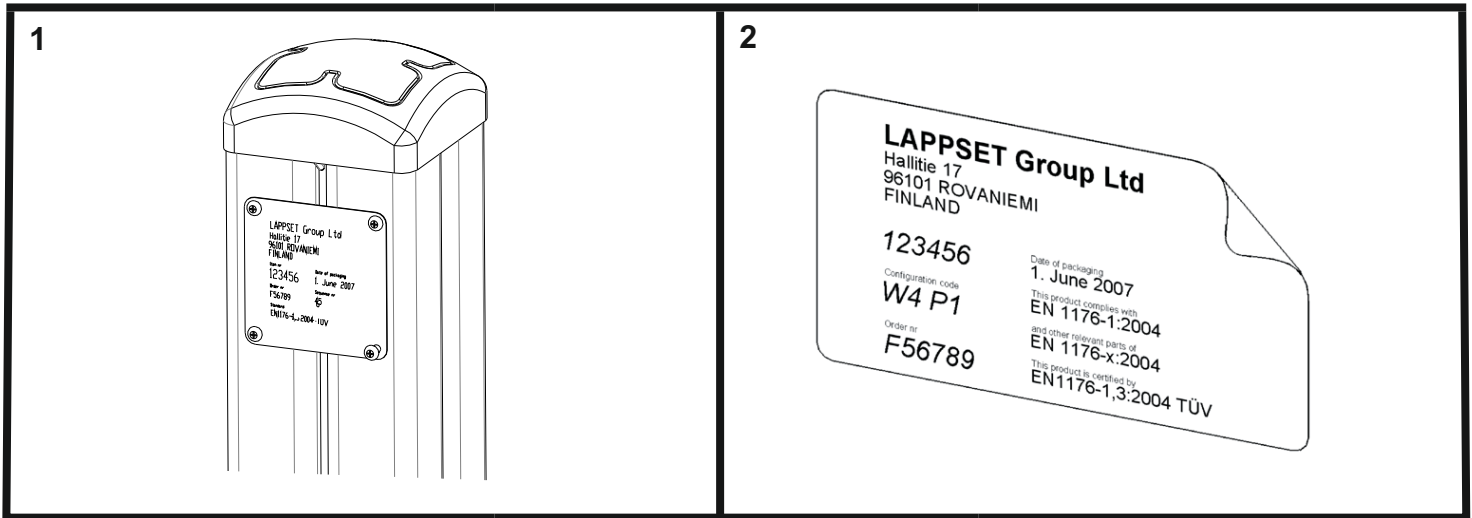

**Tuotekyltti tulee tuotteen mukana yhdellä seuraavista tavoista:**

**1) Metallinen tuotekyltti ja kiinnitysruuvit**

- Kiinnitä tuotekyltti ruuveilla tolppaan noin 2 metrin korkeuteen kuvan 2 mukaisesti.

**2) Tuotekylttitarra**

- Puhdista maalattu metalli- tai vaneripinta pölystä ja kosteudesta. Liimaa tarra kuvan 3 mukaisesti.
- Huom. Älä kiinnitä tarraa karheapintaiseen laminaattiin tai maalattuun puuhun.

**Vår produktmärkning levereras på ett av följande sätt:**

**1) Produktskylt i metall**

- Fäst skylten med de medföljande skruvarna

**2) Självhäftande produktetikett**

- Rengördenpulverlackerademetallytanellerlaminatytansåattdenblirfrifrånsmutsochfukt.Fästetikettenenligtfig.3.
- Obs! Fäst ej etiketten på detaljer med skrovlig yta eller på målat trä.

**Product label is delivered by one of following ways:**

**1) Metal product label and screws**

- Fasten the label with screws.

**2) Label sticker**

- Cleanthepaintedmetalorplywoodsurfacefromdirtandmoisture.Fastenthestickerasshowninthefigure3.
- Note. Do not attach the sticker to rough surfaced laminate or painted wood.

**La plaque d'informations produit est livrée sous l'une de ces 3 formes :**

**1) Plaque métallique et vis**

- Fixez la plaque à l'aide des vis.

**2) Etiquette autocollante**

- Avant de coller l'étiquette, nettoyez le composant métallique peint ou la plaque de contreplaqué, de toute saleté. La surface doit être sèche (voir image 3).
- Attention, ne pas coller l'étiquette sur une surface lamellé-collée irrégulière ou sur du bois peint.

**Die Auslieferung des Produktaufklebers erfolgt auf eine dieser Arten:**

**1) Produkt-Schild aus Metall incl. Schrauben**

- Die Befestigung des Schildes erfolgt mittels der Schrauben.

**2) Aufkleber**

- EntfernenSiezunächstSchmutzundFeuchtigkeitvomlackiertenMetallbzw.vonderHolzoberflächeundbringenSiedenAufkleber wie im Bild oben rechts beschrieben auf den gesäuberten Untergrund auf.
- Beachten Sie: Bringen Sie den Aufkleber nicht auf raues laminiertes oder lackiertes Holz an.