

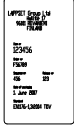









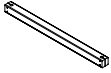





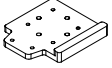

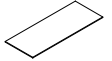
| | | | |
|---|------------|---|-----------|
| ① 702341  90x50 | PCS 1 | ② 707213  118x118x1490 | PCS 4 |
| ③ 707517  118x118x1892 | PCS 4 | ④ 708137  118x118x745 | PCS 4 |
| ⑤ 708836  15x745x1736 | PCS 2 | ⑥ 708837  15x745x2168 | PCS 2 |
| ⑦ 708839  15x745x1897 | PCS 1 | ⑧ 708840  15x148x2018 | PCS 2 |
| ⑨ 708841  15x148x1616 | PCS 2 | ⑩ 708857 JIG  20x133x149 | PCS 1 |
| ⑪ 911288 COLOR  15x745x1465 | PCS 2 | ⑫ 911289 COLOR  15x745x1897 | PCS 1 |
| ⑬ 980123  Ø7x60 | PCS 108 | ⑭ 900240  Ø8x70 | PCS 64 |
| ⑮ 903093  Ø8x90 | PCS 32 | ⑯ 905103  PT-28/32-H | PCS 16 |

| | | | | | | | | | | | |
|---|-----|---|-----|--|-----|--|-----|--|-----|--|-----|
| ⑰ 905112 | PCS | ⑱ 910266 | PCS | | PCS | | PCS | | PCS | | PCS |
| | 32 |  | 16 | | | | | | | | |
|  | | 90x108x118 | | | | | | | | | |
| Ø22 | | | | | | | | | | | |

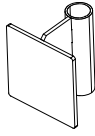
FOOT OPTIONS

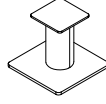
| | | | |
|---|-----|---|-----|
| 709261+ | | 709262+ | |
| ○ 910330 | PCS | ○ 910567 | PCS |
| SURFACE | 4 | CONCRETE | 4 |
|  | |  | |
| 152x200x200 | | 117x117x715 | |

----- Falling Space 22.7 m2
 Max Falling Height 920 mm

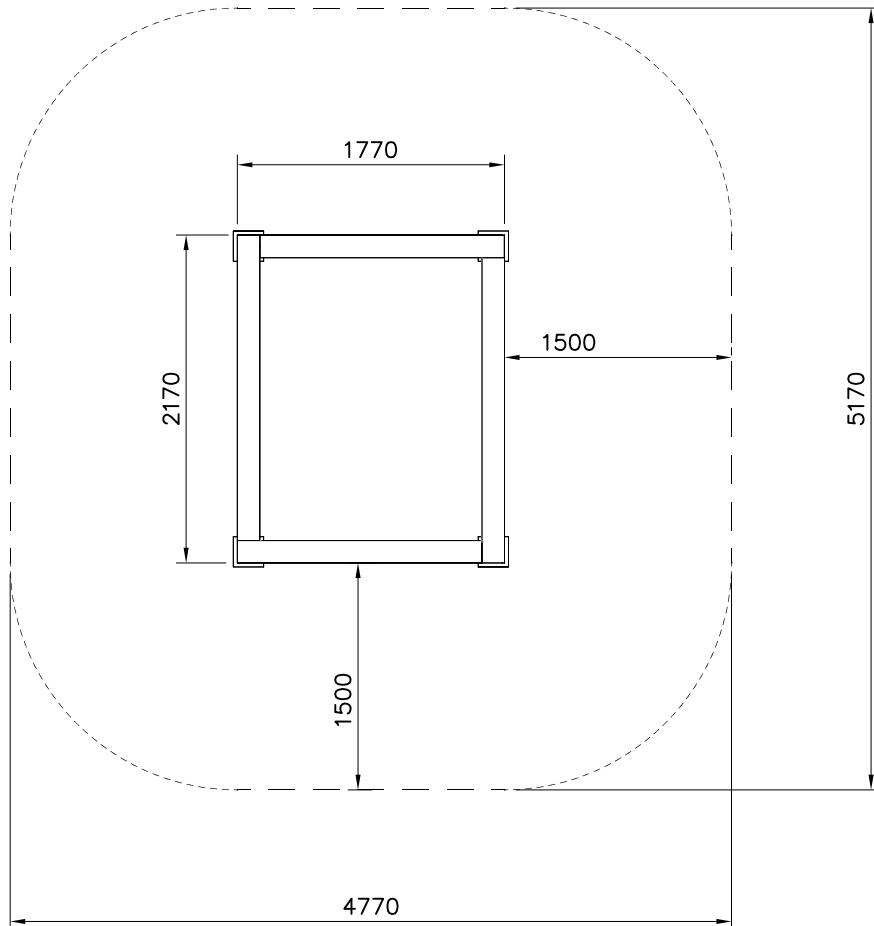
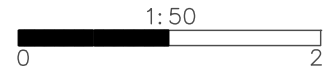

DET 1

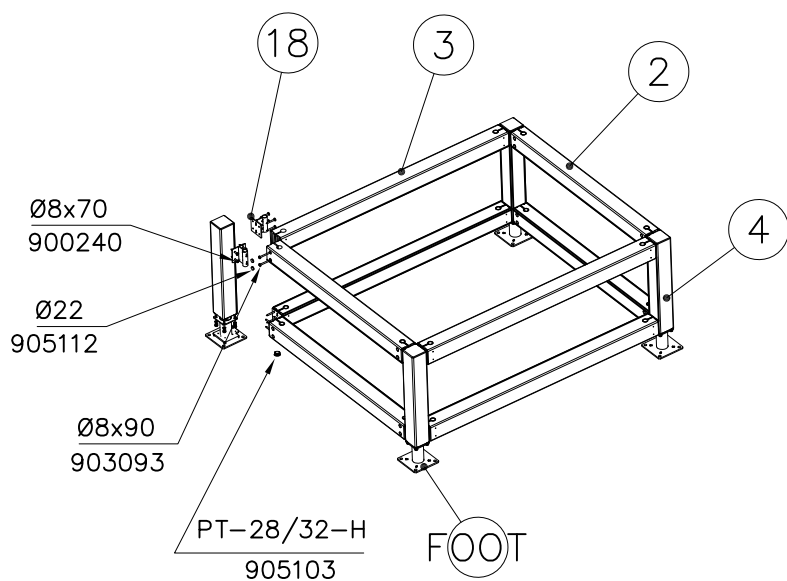

NOTE:
Use drill jig 708857
to predrill $\text{Ø}5\sqrt{50}$
holes for 910266

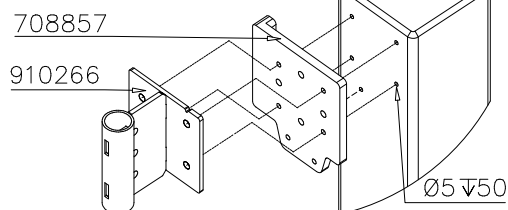

DET 2

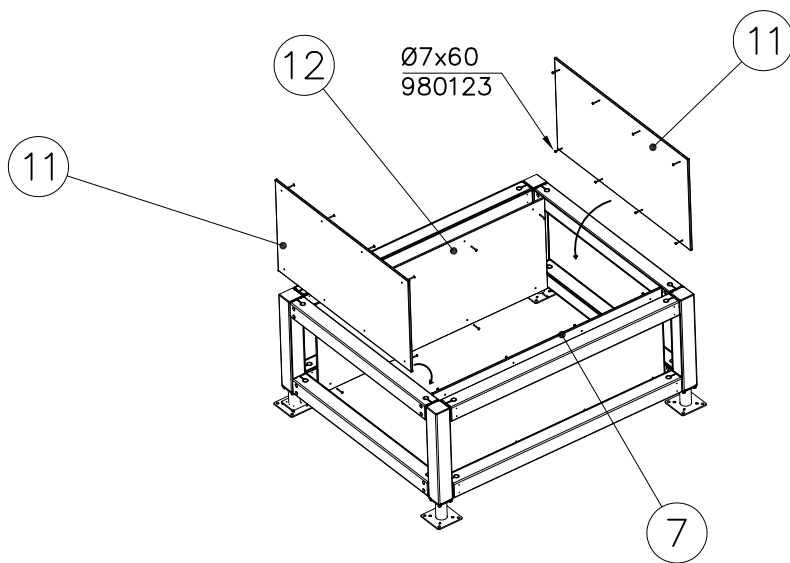

DET 3

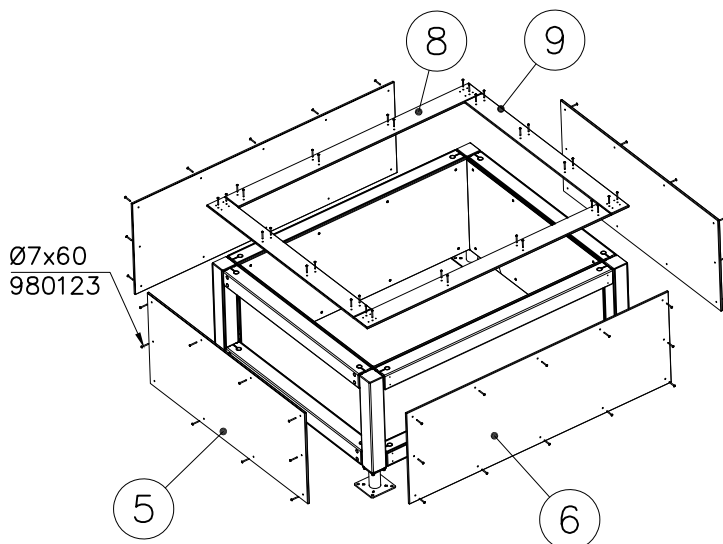

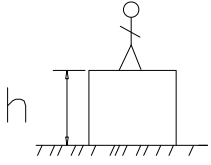

$h < 1600$

Totally hard surfaces or materials with very limited impact attenuating properties.

Case by case risk assessment is needed including e.g. evaluation whether there is forced movement, what is the intended exercise and where will the product be installed.

Materials with significant impact attenuating properties.

Totally hard surfaces.
E.g. concrete or asphalt



Materials with very limited impact attenuating properties.
E.g. wood



fine gravel 0–8 mm



Unsorted sand/ topsoil

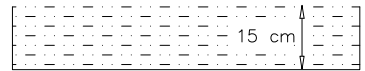

Lawn

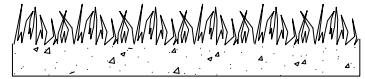

$h = 1600-$

$h < 3000$

Loose fill material

E.g.
sand/gravel 0,25...8 mm $D_{60}/D_{10} < 3,0$
Woodchips 5...30 mm
bark 20...80 mm

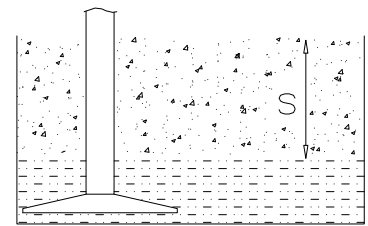

$\frac{S}{30 \text{ cm}}$ $\frac{h}{< 3,0 \text{ m}}$

Synthetic granulates

| $\frac{S}{\text{mm}}$ | $\frac{h}{\text{m}}$ |
|-----------------------|-------------------------------|
| 40 mm | $\sim > 1,6... \sim < 1,8$ m |
| 50 mm | $\sim > 1,8... \sim < 2,25$ m |
| 55 mm | $\sim > 2,25... \sim < 2,4$ m |
| 60 mm | $\sim > 2,4... \sim < 2,55$ m |
| 70 mm | $\sim > 2,55... \sim < 3,0$ m |

Note. For accurate values, see manufacturer's instructions.

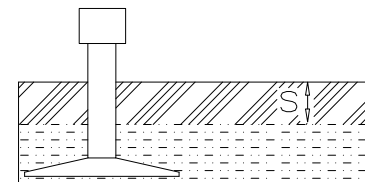

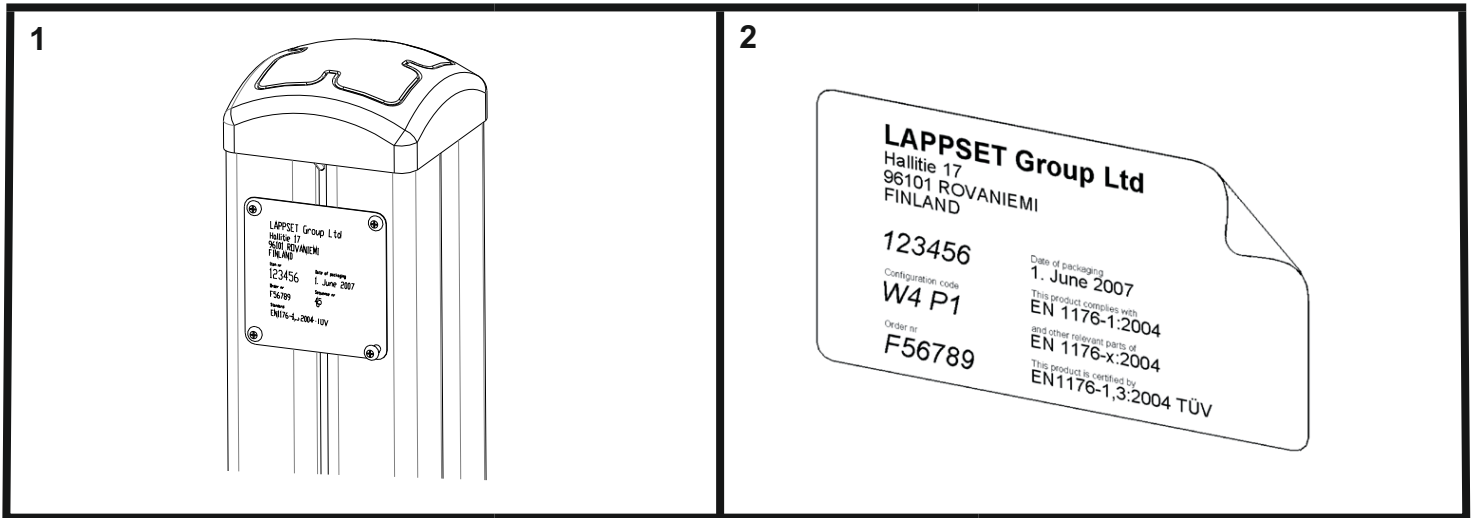

Tuotekyltti tulee tuotteen mukana yhdellä seuraavista tavoista:

1) Metallinen tuotekyltti ja kiinnitysruuvit

- Kiinnitä tuotekyltti ruuveilla tolppaan noin 2 metrin korkeuteen kuvan 2 mukaisesti.

2) Tuotekylttitarra

- Puhdista maalattu metalli- tai vaneripinta pölystä ja kosteudesta. Liimaa tarra kuvan 3 mukaisesti.
- Huom. Älä kiinnitä tarraa karheapintaiseen laminaattiin tai maalattuun puuhun.

Vår produktmärkning levereras på ett av följande sätt:

1) Produktskylt i metall

- Fäst skylten med de medföljande skruvarna

2) Självhäftande produktetikett

- Rengördenpulverlackerademetallytanellerlaminatytansåttndenblirfrifrånsmutsochfukt.Fästetikettenenligtfig.3.
- Obs! Fäst ej etiketten på detaljer med skrovlig yta eller på målat trä.

Product label is delivered by one of following ways:

1) Metal product label and screws

- Fasten the label with screws.

2) Label sticker

- Cleanthepaintedmetalorplywoodsurfacefromdirtandmoisture.Fastenthestickerasshowninthefigure3.
- Note. Do not attach the sticker to rough surfaced laminate or painted wood.

La plaque d'informations produit est livrée sous l'une de ces 3 formes :

1) Plaque métallique et vis

- Fixez la plaque à l'aide des vis.

2) Etiquette autocollante

- Avant de coller l'étiquette, nettoyez le composant métallique peint ou la plaque de contreplaqué, de toute saleté. La surface doit être sèche (voir image 3).
- Attention, ne pas coller l'étiquette sur une surface lamellé-collée irrégulière ou sur du bois peint.

Die Auslieferung des Produktaufklebers erfolgt auf eine dieser Arten:

1) Produkt-Schild aus Metall incl. Schrauben

- Die Befestigung des Schildes erfolgt mittels der Schrauben.

2) Aufkleber

- EntfernenSiezunächstSchmutzundFeuchtigkeitvomlackiertenMetallbzw.vonderHolzoberflächeundbringenSiedenAufkleber wie im Bild oben rechts beschrieben auf den gesäuberten Untergrund auf.
- Beachten Sie: Bringen Sie den Aufkleber nicht auf raues laminiertes oder lackiertes Holz an.

LAPPSET®

SURF. FOUNDATION

709261

DATE: 15.8.2019

1(1)

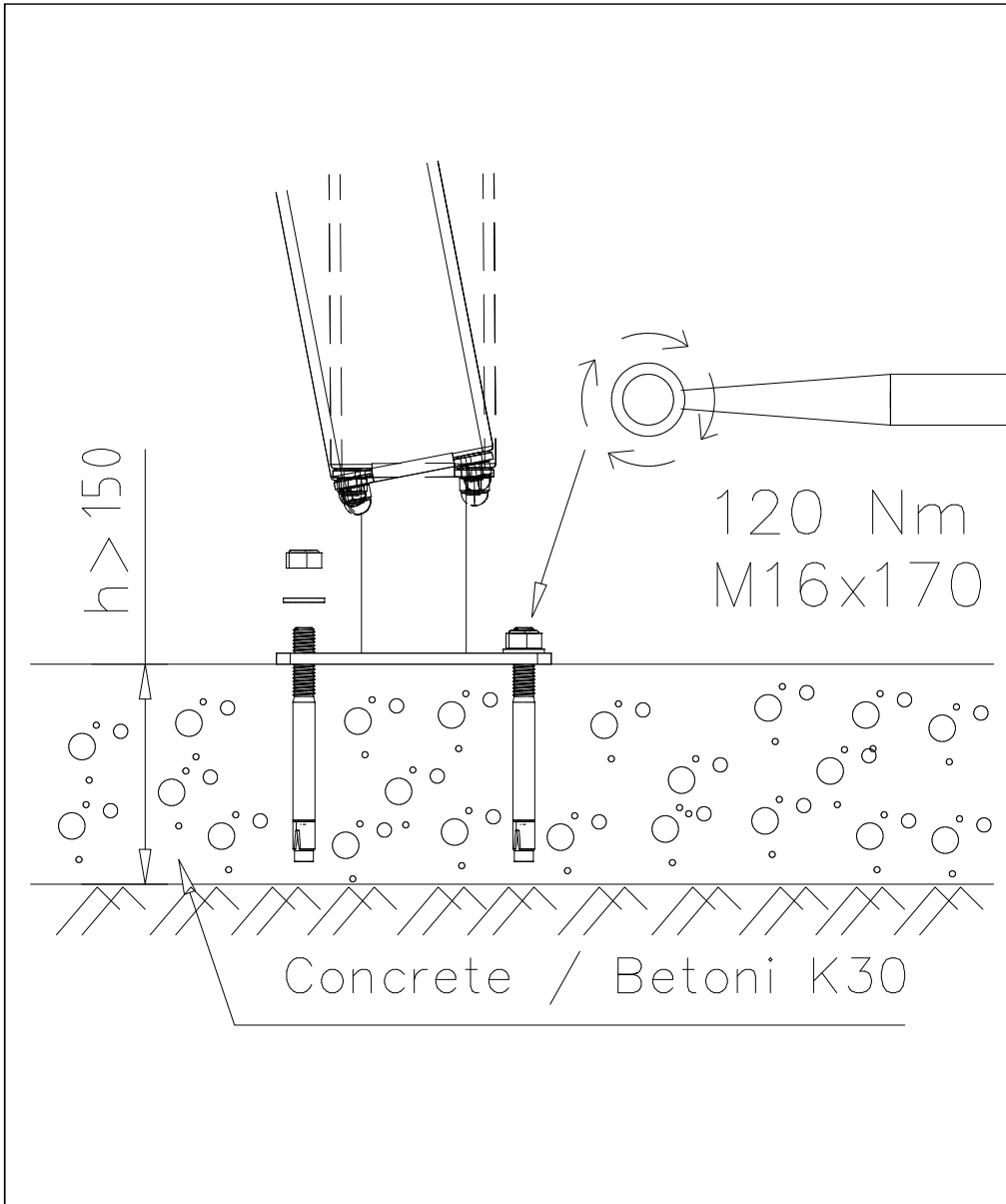

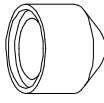
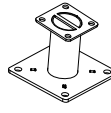
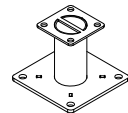
| | | | |
|---|-----|---|-----|
| ① 904450 | PCS | ② 905104 | PCS |
|  | 4 |  | 4 |
| M16x170 | | M10 | |
| | PCS | | PCS |
| | | | |
| | PCS | | PCS |
| | | | |
| ③ 910267 | PCS | ④ 910330 | PCS |
|  | 1 |  | 2 |
| 152x200x200 | | 152x200x200 | |
| | PCS | | PCS |
| | | | |

Ø16 ↓ > 130

