

LAPPSET®

DASH PARKOUR



ASENNUSOHJE
MONTERINGSANSVISNING
INSTALLATION INSTRUCTION
AUFBAUANLEITUNG
NOTICE D'INSTALLATION

DATE: 18.2.2020

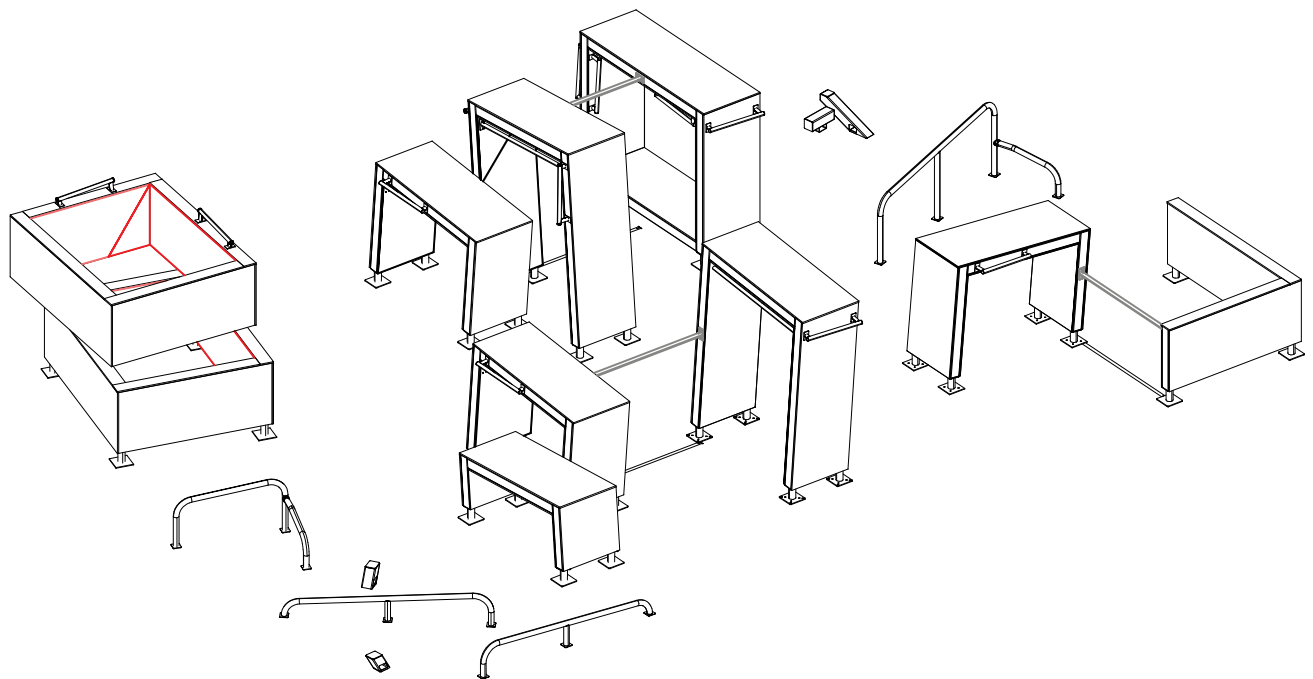
081784M

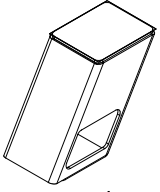
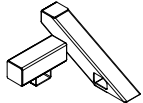
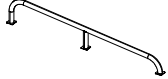
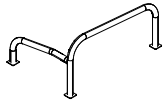
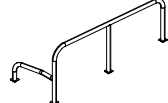
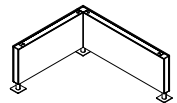
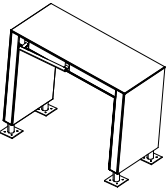
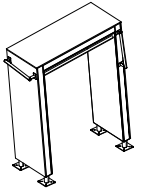
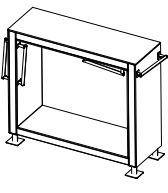
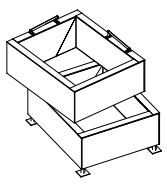
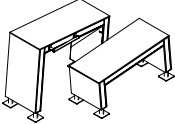
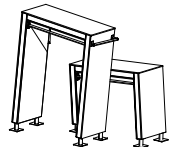
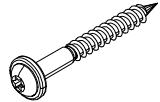

DATE: 18.2.2020

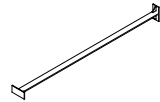
081700M  PCS 2	081701M  PCS 1	081710M  PCS 2	081711M  PCS 1	081712M  PCS 1	081722M  PCS 1
081731M  PCS 1	081732M  PCS 1	081733M  PCS 1	081734M  PCS 1	081735M  PCS 1	081737M  PCS 1
900240  PCS 24 Ø8x70	910328  PCS 1 L 1466	910513  PCS 2 L 1466			

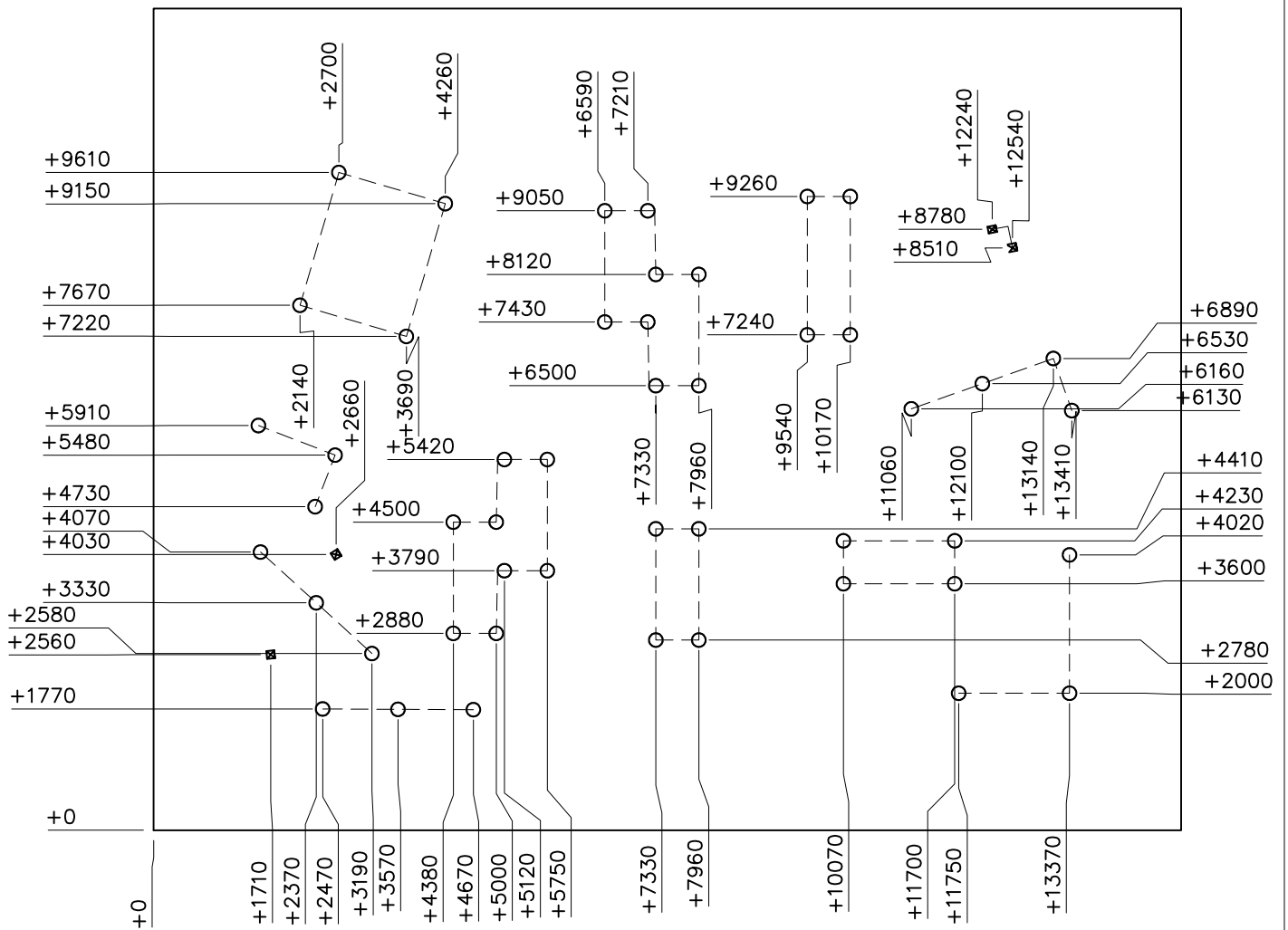
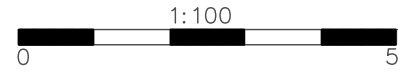

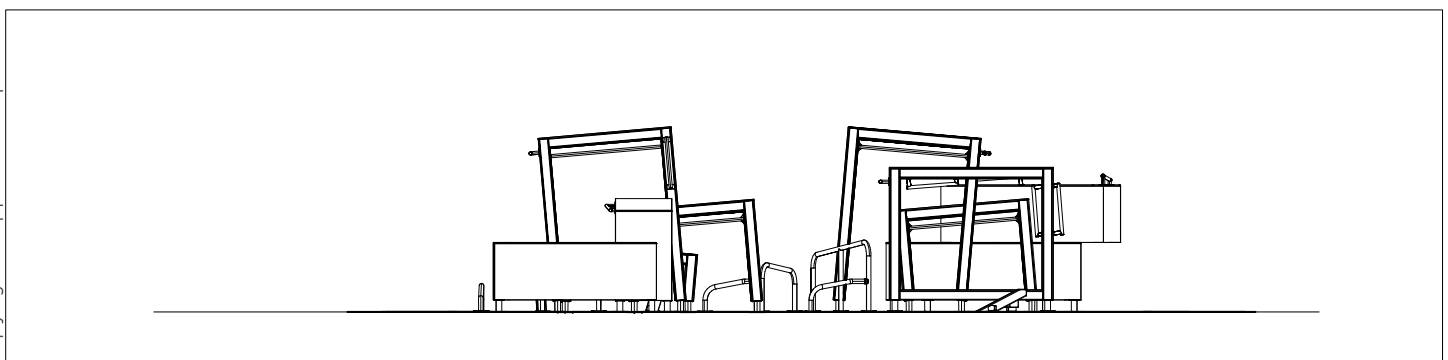
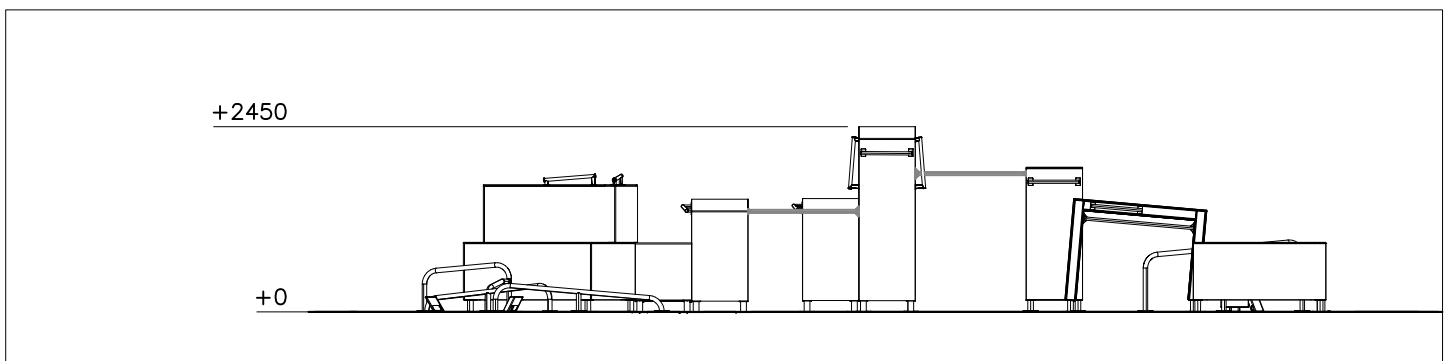
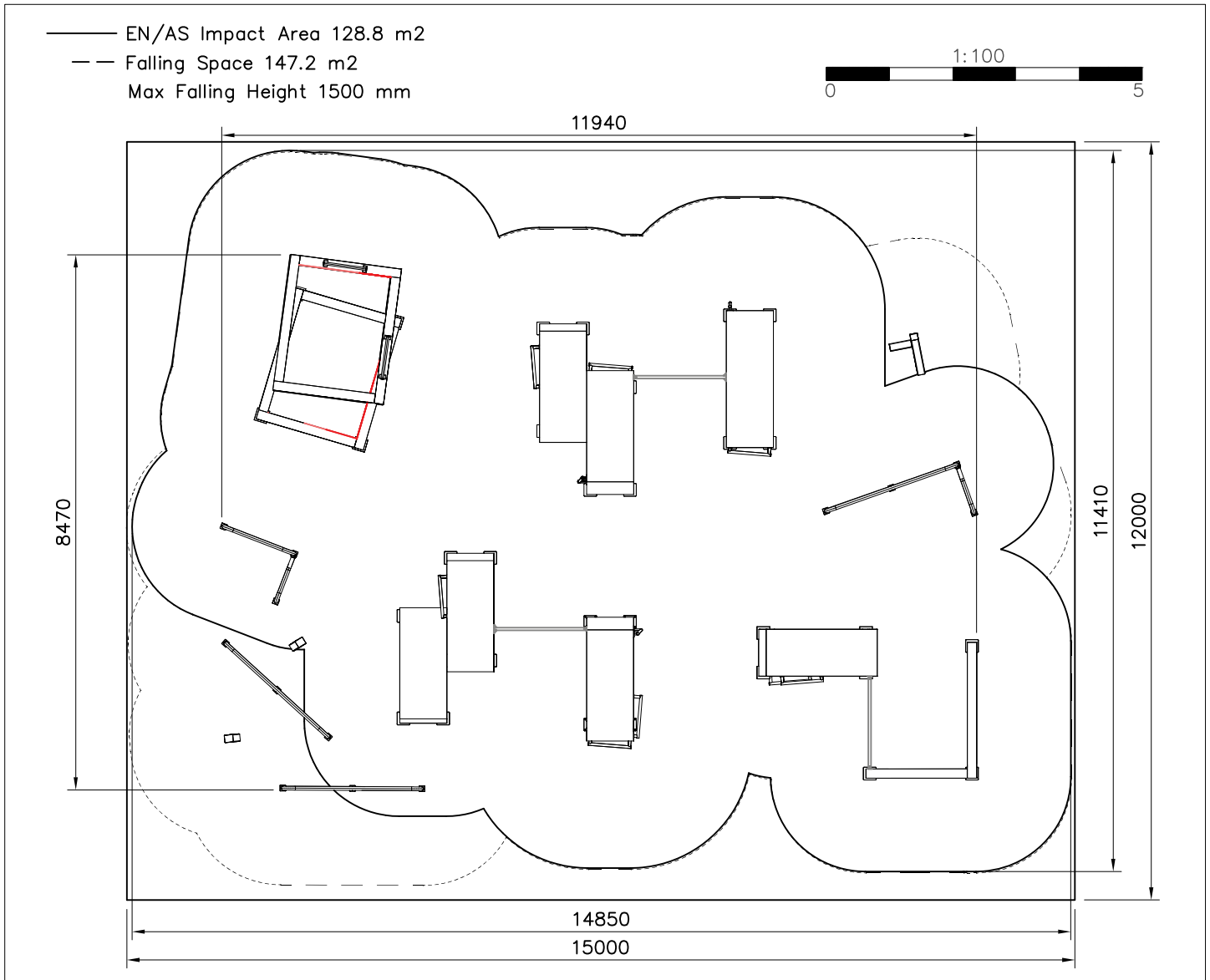

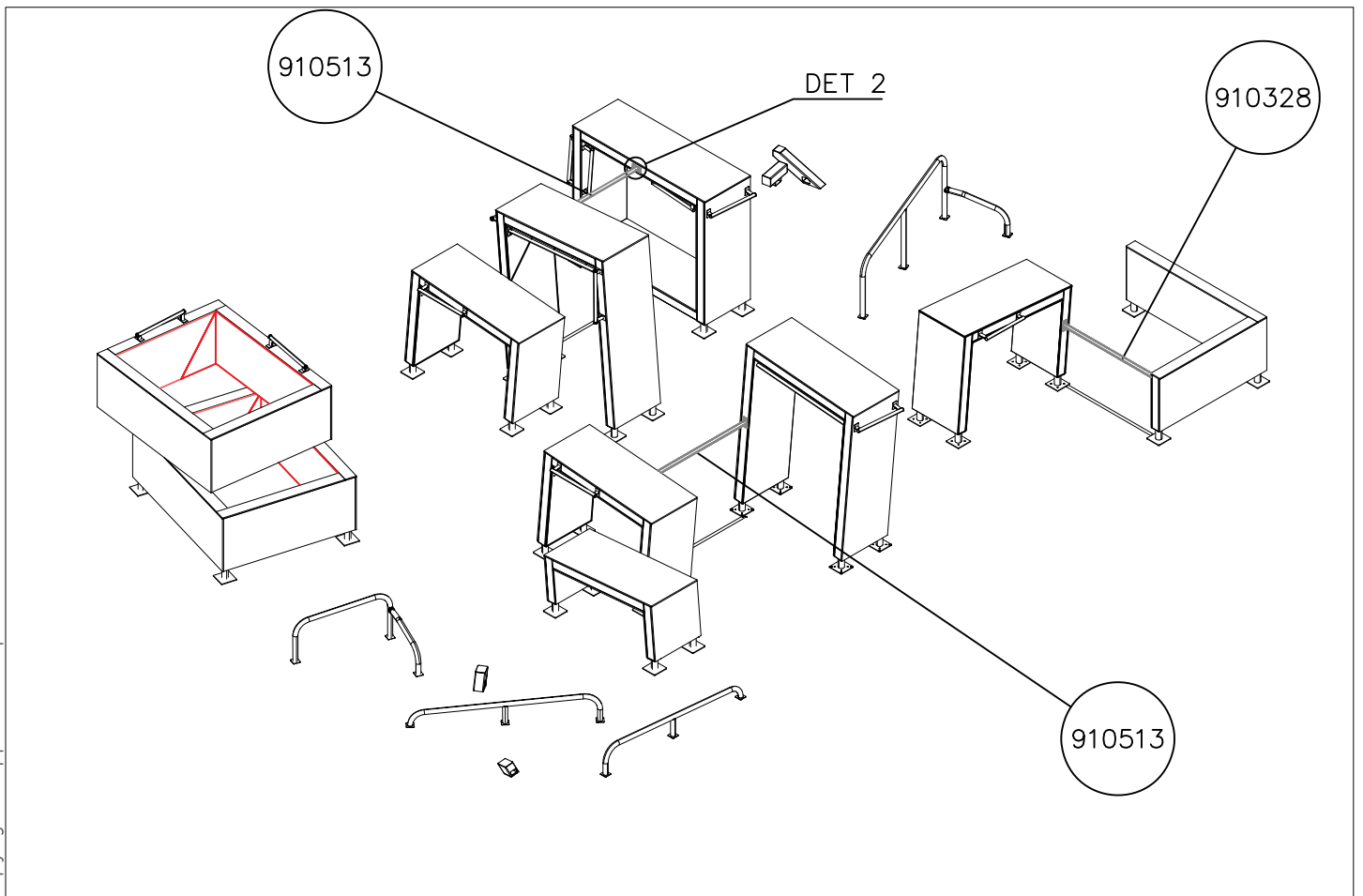
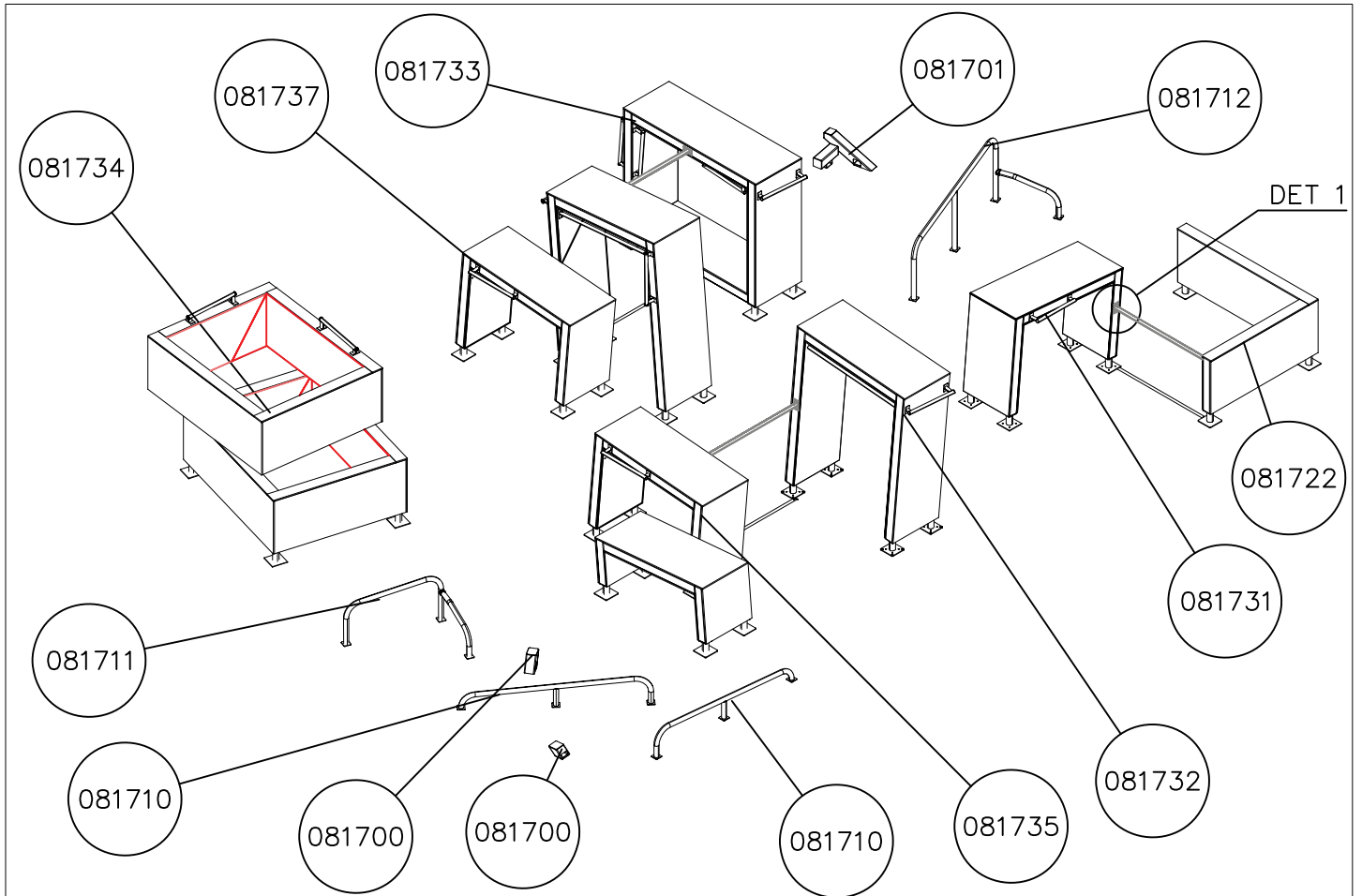

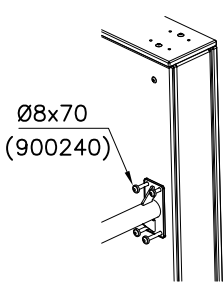
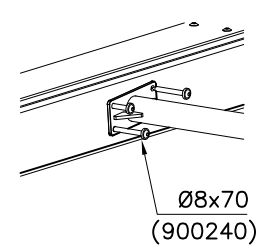
<p>DET 1</p>  <p>Ø8x70 (900240)</p>	<p>DET 2</p>  <p>Ø8x70 (900240)</p>		

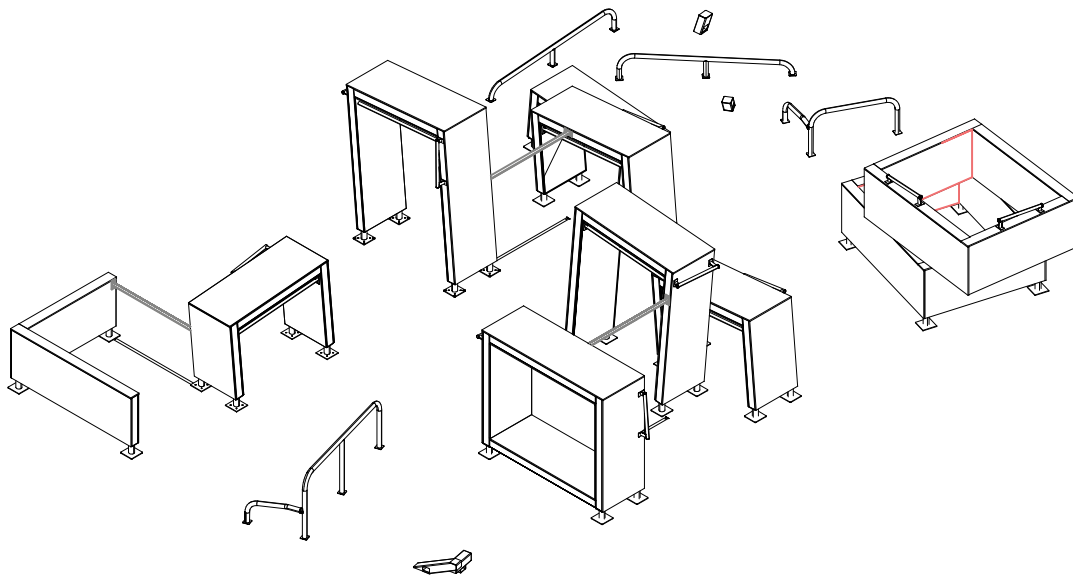
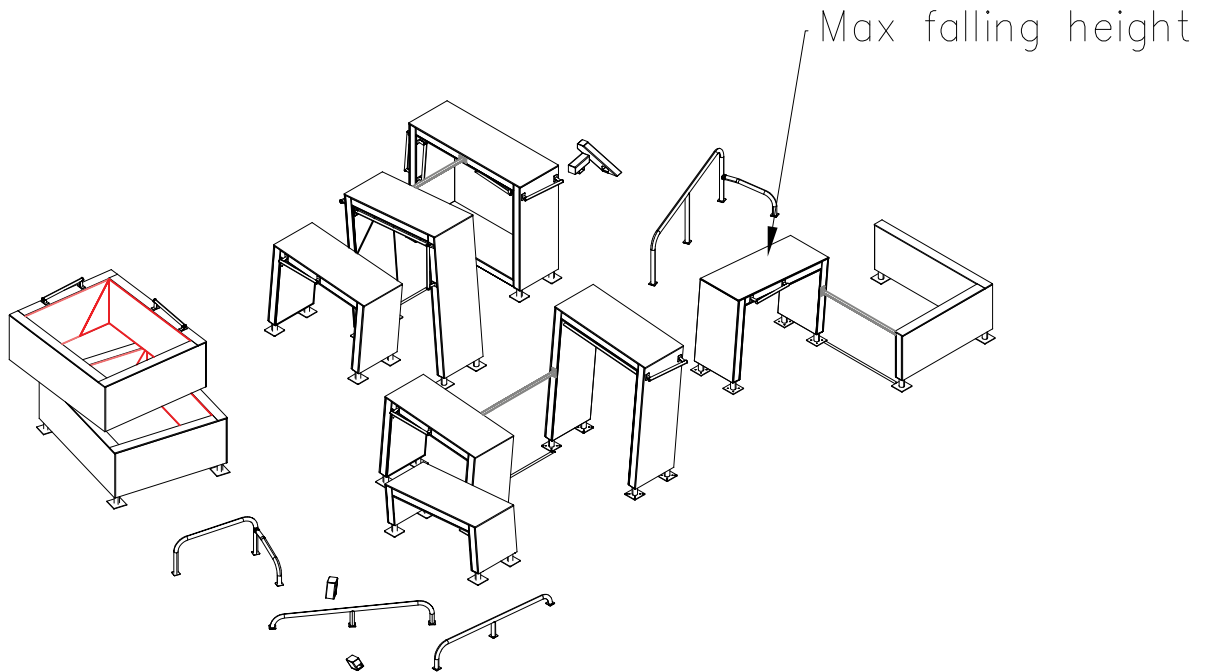

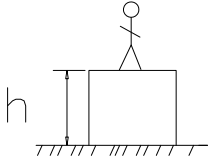

$h < 1600$

Totally hard surfaces or materials with very limited impact attenuating properties.

Case by case risk assessment is needed including e.g. evaluation whether there is forced movement, what is the intended exercise and where will the product be installed.

Materials with significant impact attenuating properties.

Totally hard surfaces.
E.g. concrete or asphalt



Materials with very limited impact attenuating properties.
E.g. wood



fine gravel 0–8 mm

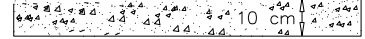

Unsorted sand/ topsoil

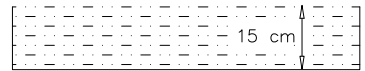

Lawn

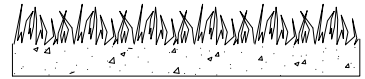

$h = 1600-$

$h < 3000$

Loose fill material

E.g.
sand/gravel 0,25...8 mm $D_{60}/D_{10} < 3,0$
Woodchips 5...30 mm
bark 20...80 mm

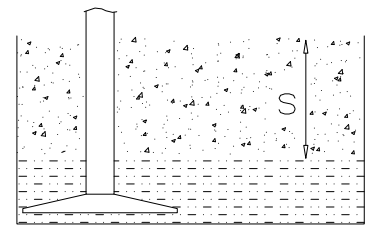

\underline{S}
30 cm \underline{h}
< 3,0 m

Syntethic granulates

\underline{S} \underline{h}
40 mm $\sim >$ 1,6... $\sim <$ 1,8 m
50 mm $\sim >$ 1,8... $\sim <$ 2,25 m
55 mm $\sim >$ 2,25... $\sim <$ 2,4 m
60 mm $\sim >$ 2,4... $\sim <$ 2,55 m
70 mm $\sim >$ 2,55... $\sim <$ 3,0 m

Note. For accurate values, see manufacturer's instructions.

