

LAPPSET®

FITNESS

ASENNUSOHJE
MONTERINGSANSVISNING
INSTALLATION INSTRUCTION
AUFBAUANLEITUNG
NOTICE D'INSTALLATION

DATE: 4.1.2021







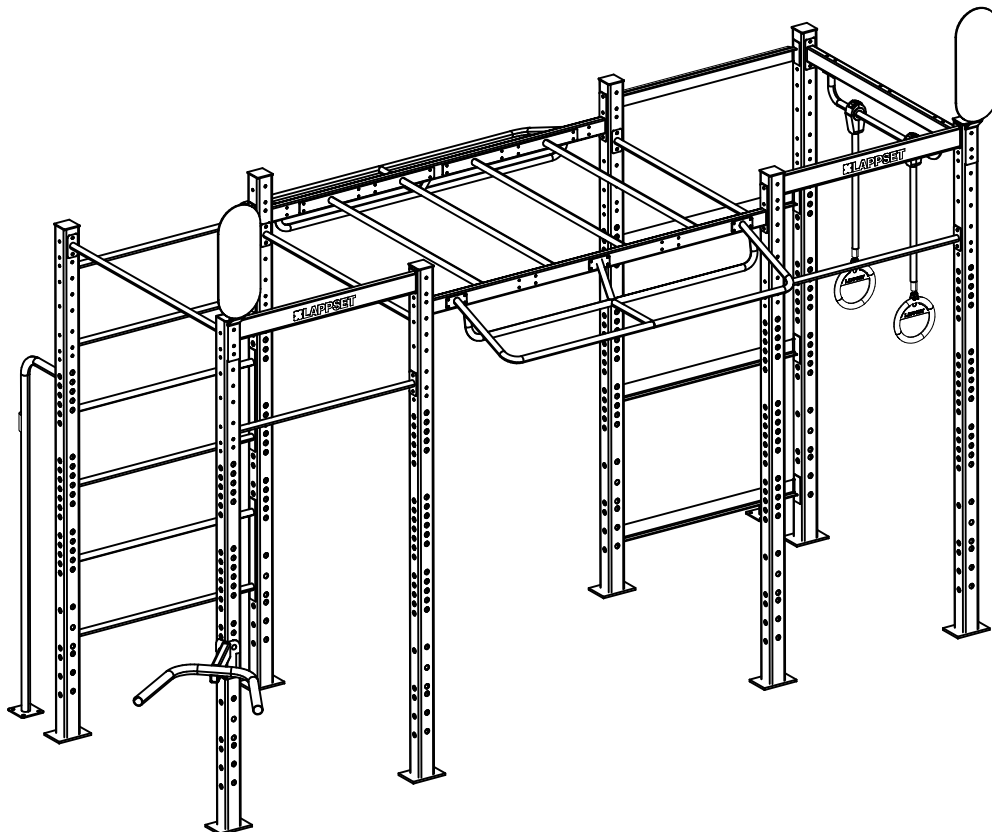





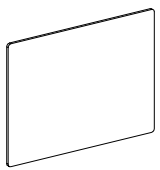
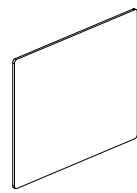
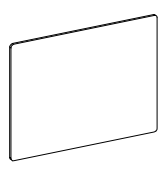
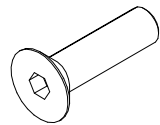

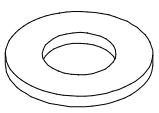
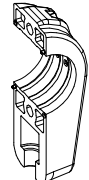
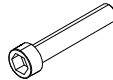

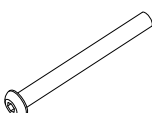
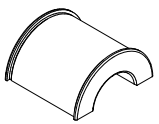
Fitness equipment is not intended for installation in the immediate vicinity of children's playgrounds in accordance with EN 1176.

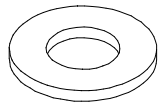
Kuntolaitteita ei ole tarkoitettu asennettaviksi lasten leikkikentän välittömään läheisyyteen standardin EN 1176 mukaisesti.

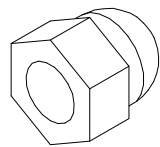
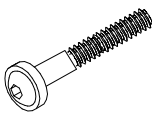
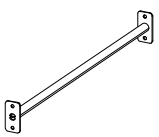
081855

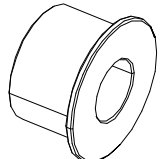
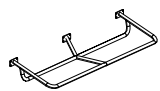
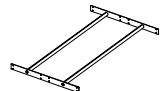
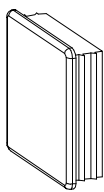
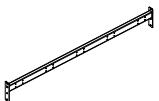
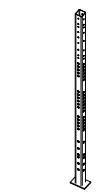
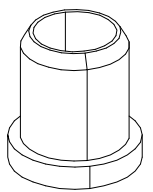
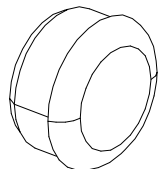

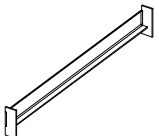
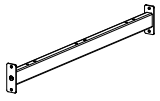
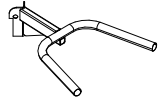
DATE: 4.1.2021

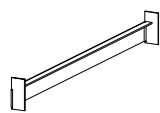
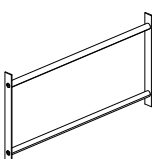
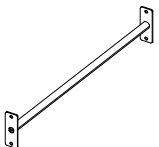
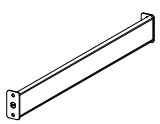
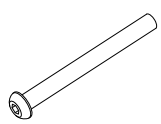
702341  90x50	PCS 1	705039  Ø16x974	PCS 2	708799-704  15x1050x798	PCS 1	708800-704  15x1050x798	PCS 1	708801-704  15x1050x798	PCS 1	900348  M8x30	PCS 24
900965  M10	PCS 87	901302  Ø20/10.5x2	PCS 144	902195  150x50x50	PCS 4	902232  M10x55	PCS 2	902233  M10x30	PCS 2	904450  M16x170	PCS 32
904917  M10x100	PCS 4	906006  Ø64/36,4x59	PCS 4	906598  366x50	PCS 3	909256  Ø16/8.4x1.6	PCS 128	909628  M10x100	PCS 8	909633  M8	PCS 64
909866  M8x60	PCS 40	910365-217  1060	PCS 2	910368-217  1315	PCS 3	910376  Ø30x17	PCS 60	910392-217  1060	PCS 2	910402-217  1060	PCS 2
910405  90x90x30	PCS 8	910408-207  1060	PCS 2	910410-207  90x90x2720	PCS 8	910415  Ø16/12,5-14x17	PCS 168	910416  Ø48/43-45x24	PCS 2	910447-217  1060	PCS 1
910455-217  1060	PCS 2	910604-217  1060	PCS 3	910614-207  1315	PCS 1	910619-217  45°	PCS 1	910625  1060	PCS 2	910626-207  1060	PCS 1
910627-217  1060	PCS 2	910628-217  1060	PCS 2	910629-207  1060	PCS 2	911149  M10x110	PCS 79		PCS		PCS

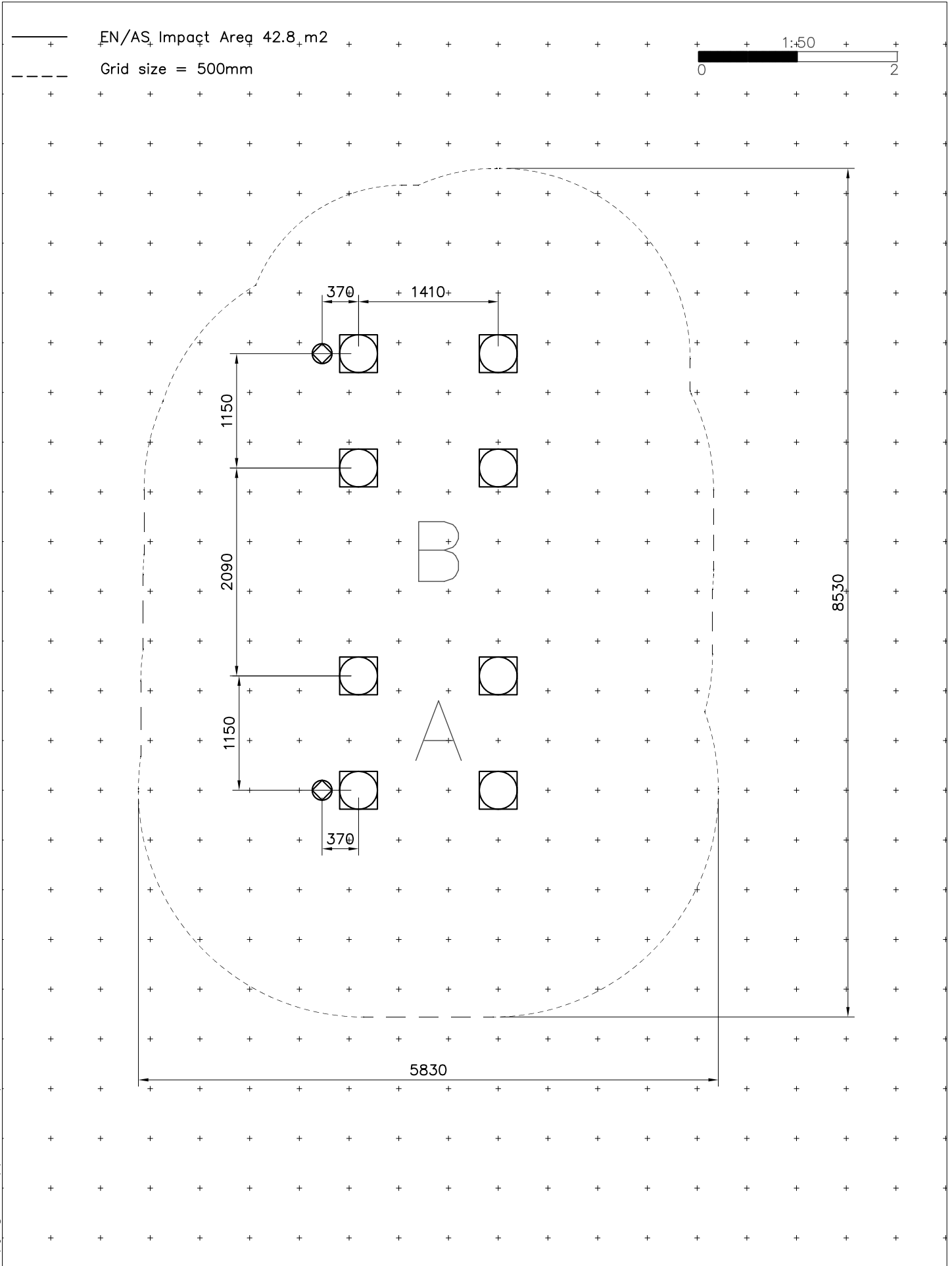

<p>Ø16 \downarrow > 130</p> <p>145</p> <p>85</p>	<p>120Nm</p> <p>M16x170</p> <p>Concrete / Betoni K30</p> <p>$h > 150$</p>	<p>Pre-drill hole Ø10 \downarrow 90 (x4)</p> <p>90</p> <p>90</p>
<p>35 Nm</p> <p>M10x100</p> <p>S</p> <p>90</p> <p>M10x100</p>		

Concrete foundation plans

1pcs 200x500x4930

1pcs 200x500x4930 + 2 extensions 460x330

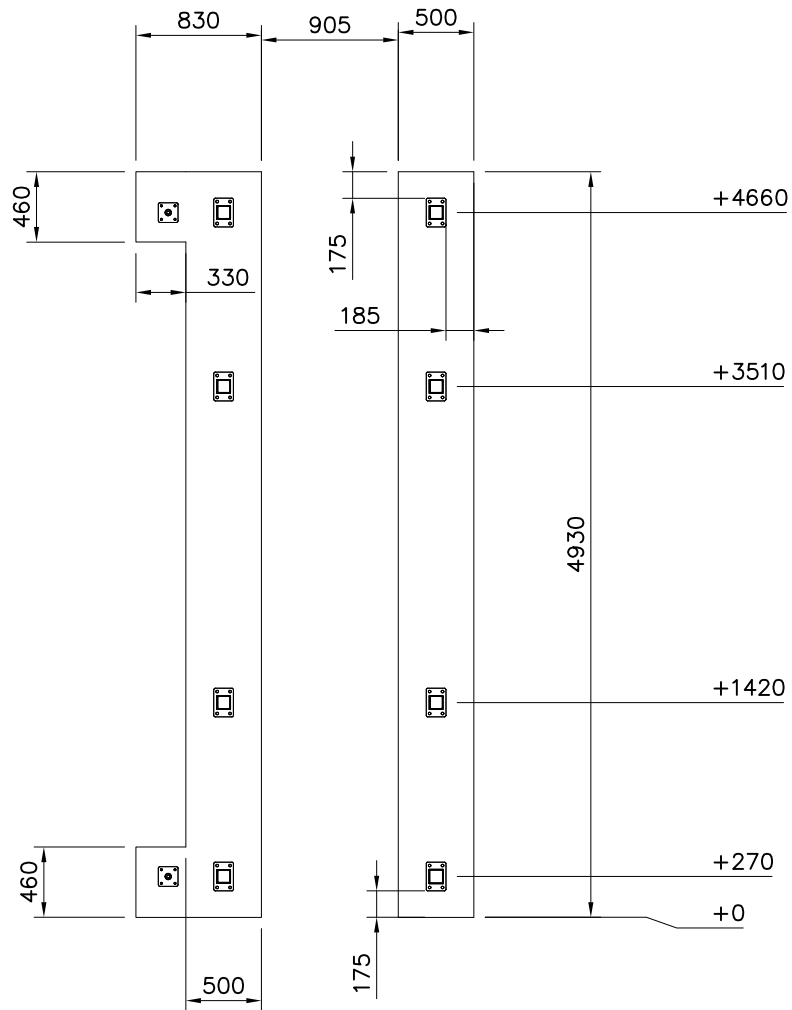

- EN/AS Impact Area 42.8 m² Max Falling Height 2510 mm
- Falling Space 42.8 m²
- Training Space Area 27.5 m²

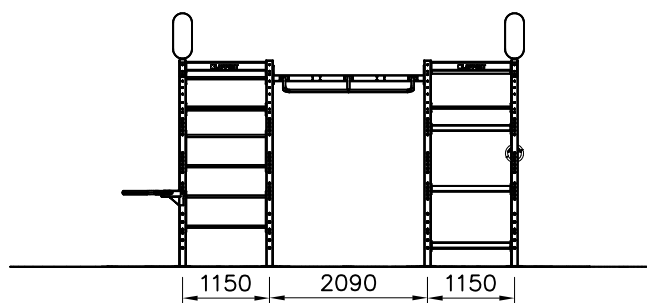
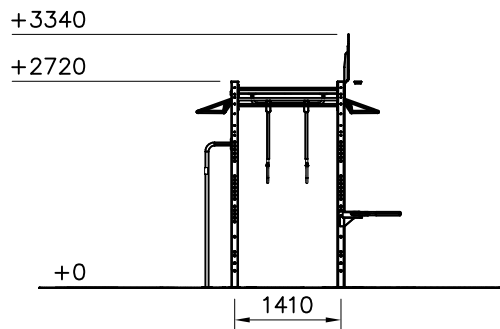
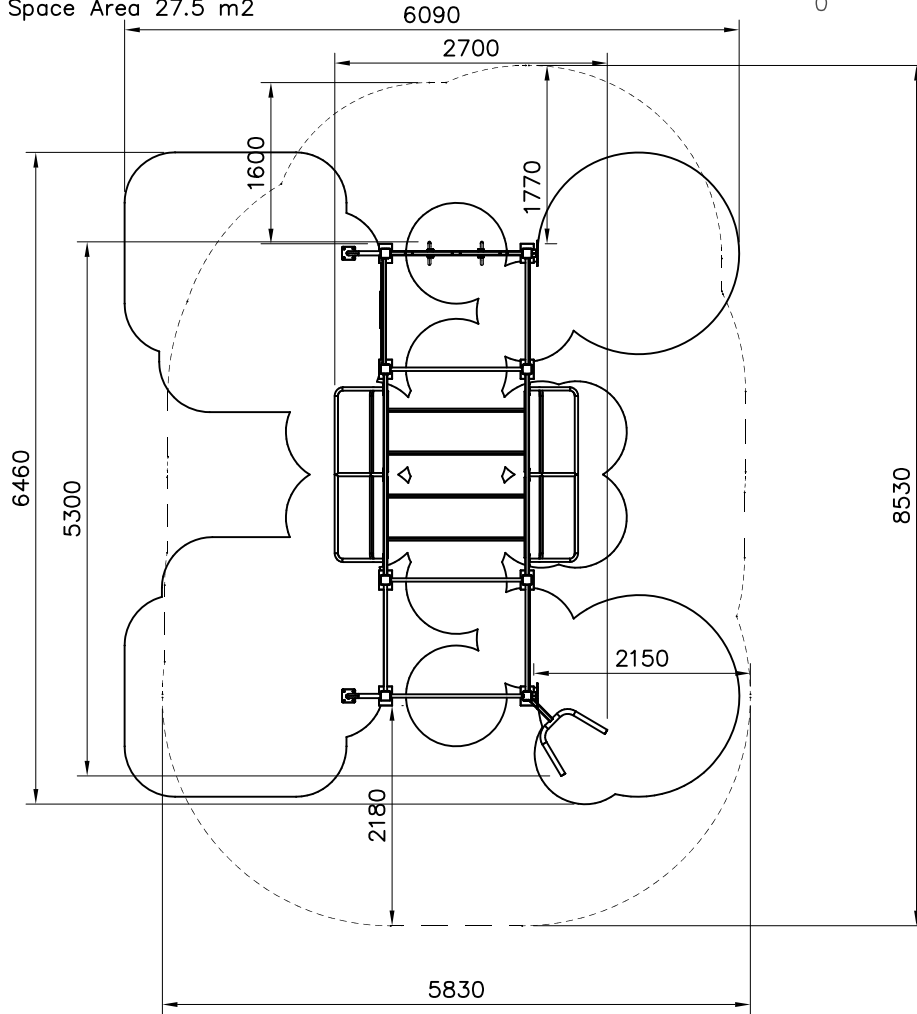
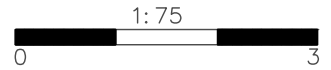

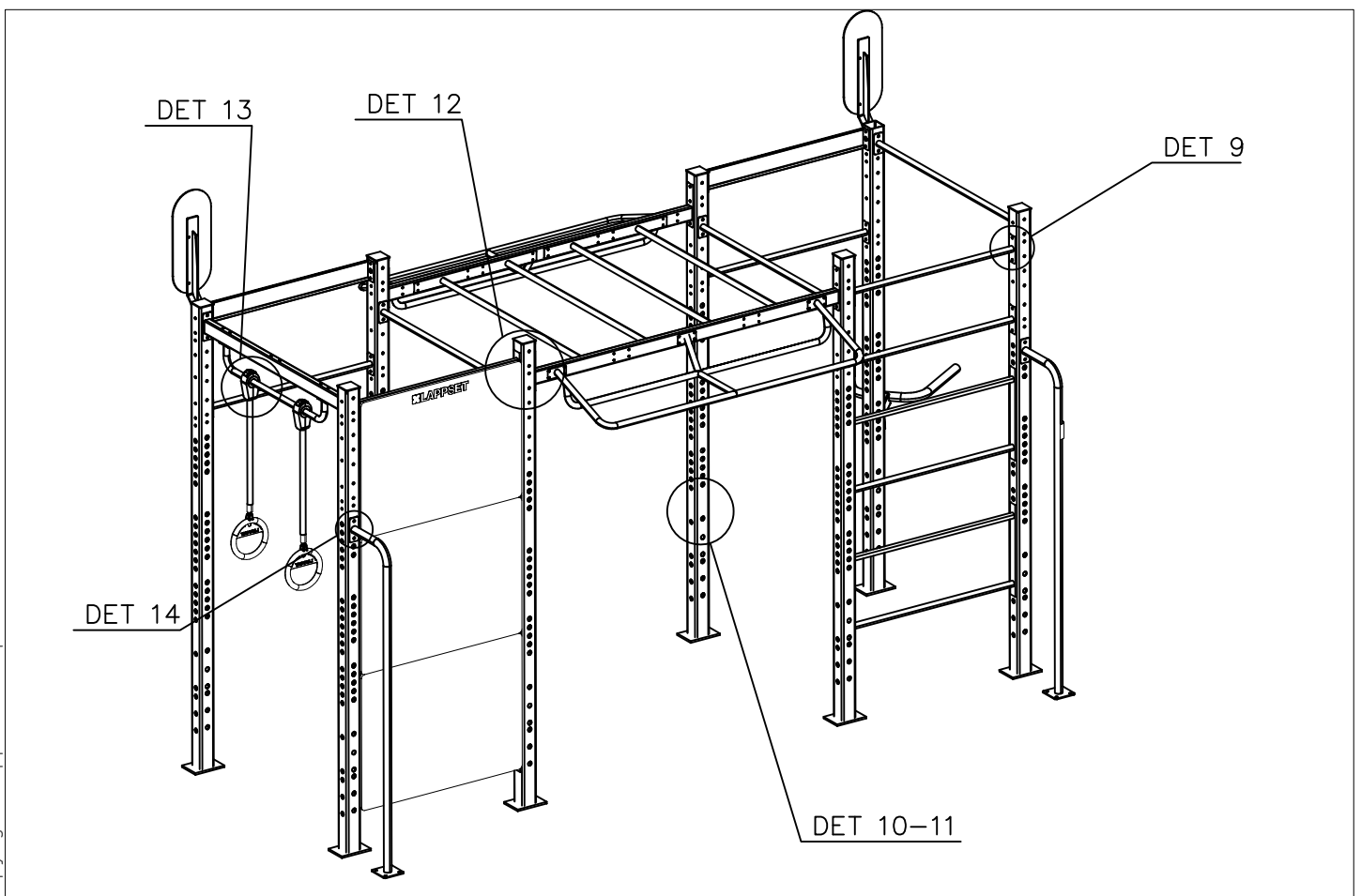
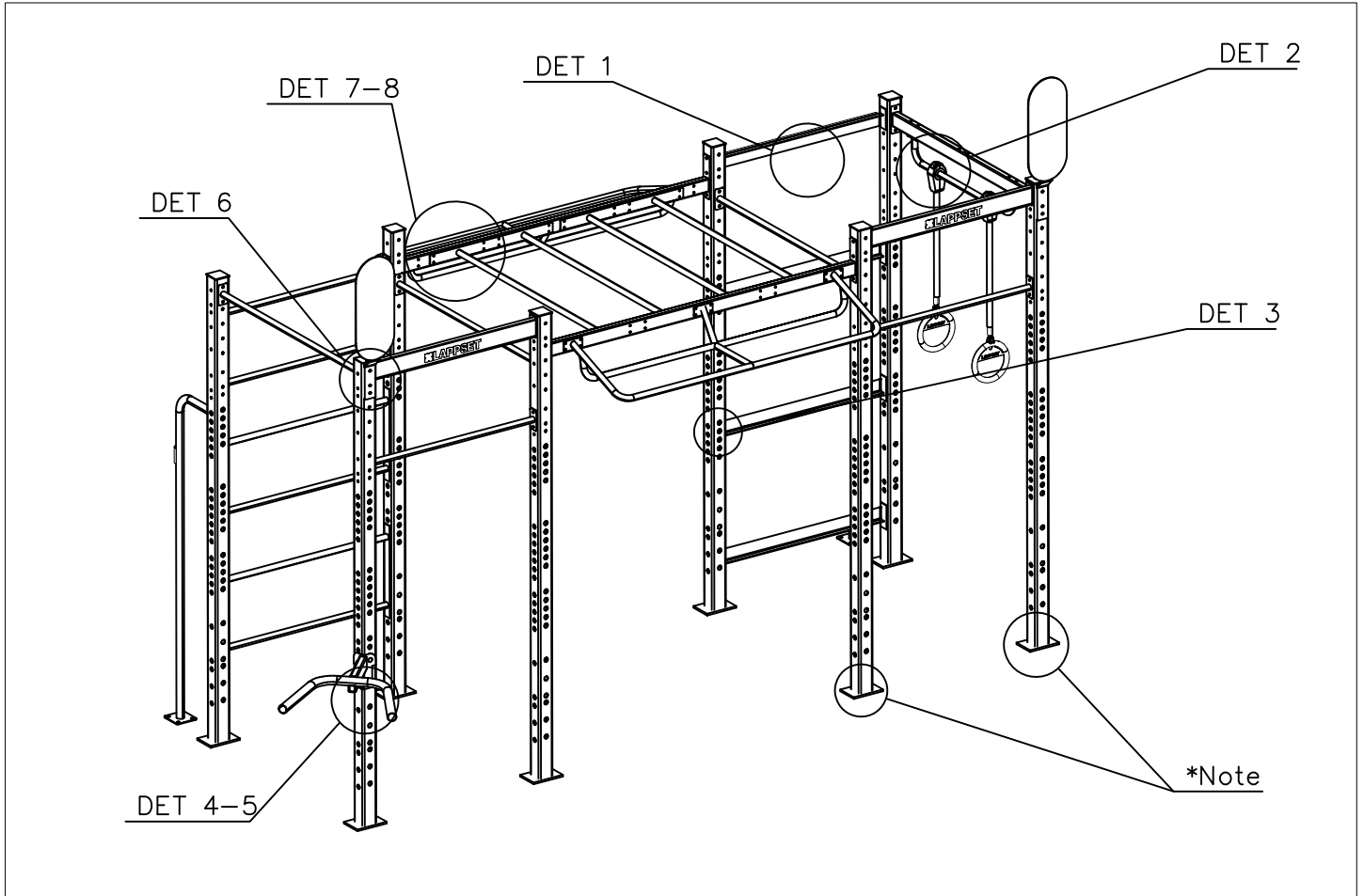

<p>DET 1</p>	<p>DET 2</p>	<p>DET 3</p>	<p>DET 4</p>
<p>DET 5</p>	<p>DET 6</p>	<p>DET 7</p>	<p>DET 8</p>
<p>DET 9</p>	<p>DET 10</p> <p>Plug the unused 13mm holes in the posts and beams with the plugs (910415)</p> <p>Tuki käyttämättömät 13mm reiät puomeissa ja tolissa tulpilla (910415)</p>	<p>DET 11</p> <p>When installing elements in the 25mm holes use the bushings (910376) on both sides of the post</p> <p>25mm reikiin asennettaessa käytä puslia (910376) tolpan molemmin puolin</p>	<p>DET 12</p>
<p>DET 13</p>	<p>DET 14</p>	<p>Note*</p> <p>All the post flanges are in the same direction</p> <p>Kaikki pylväiden jalat ovat samansuuntaisesti</p>	
<p>Copyright Lappset Group Ltd</p>			

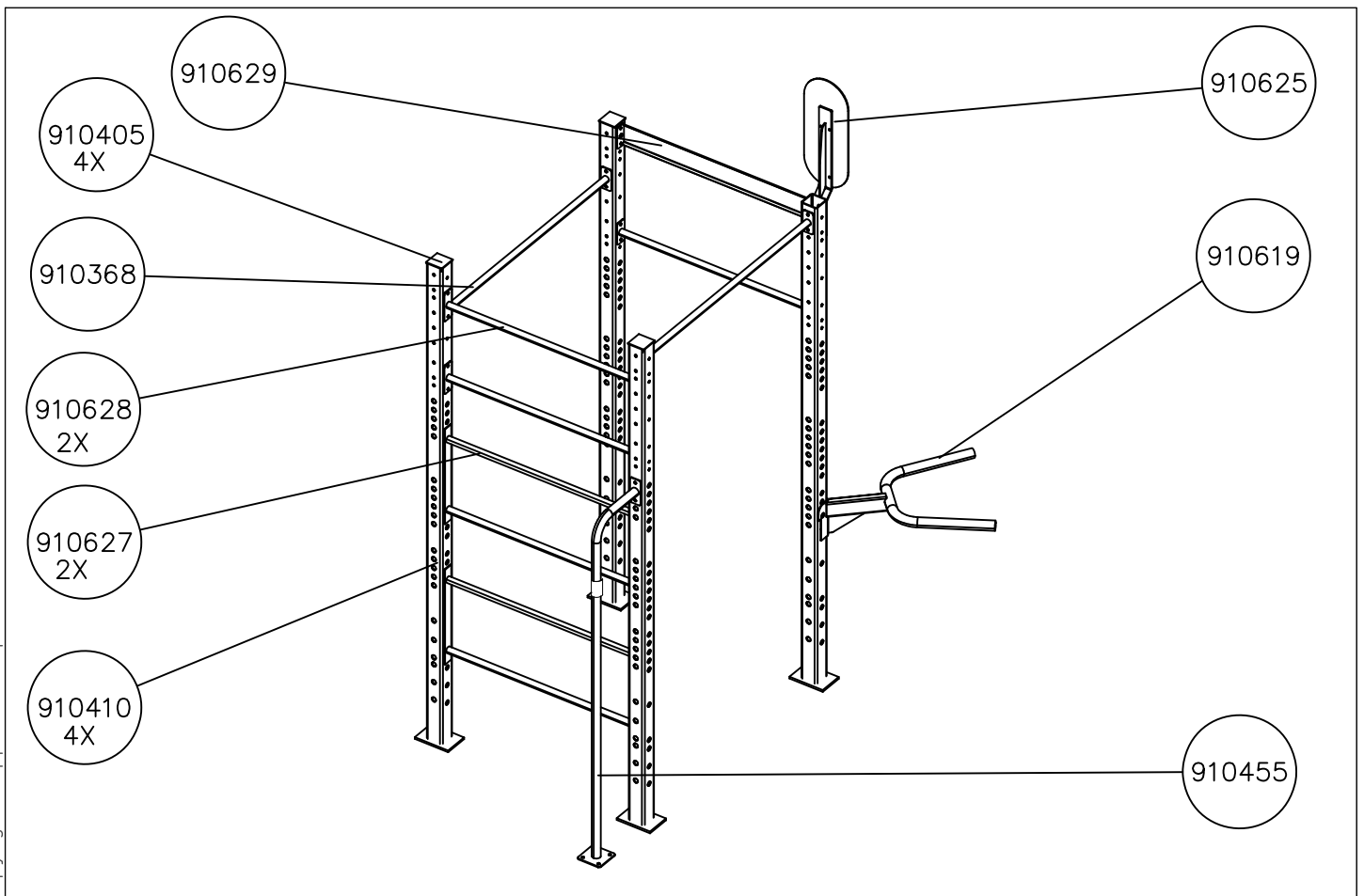
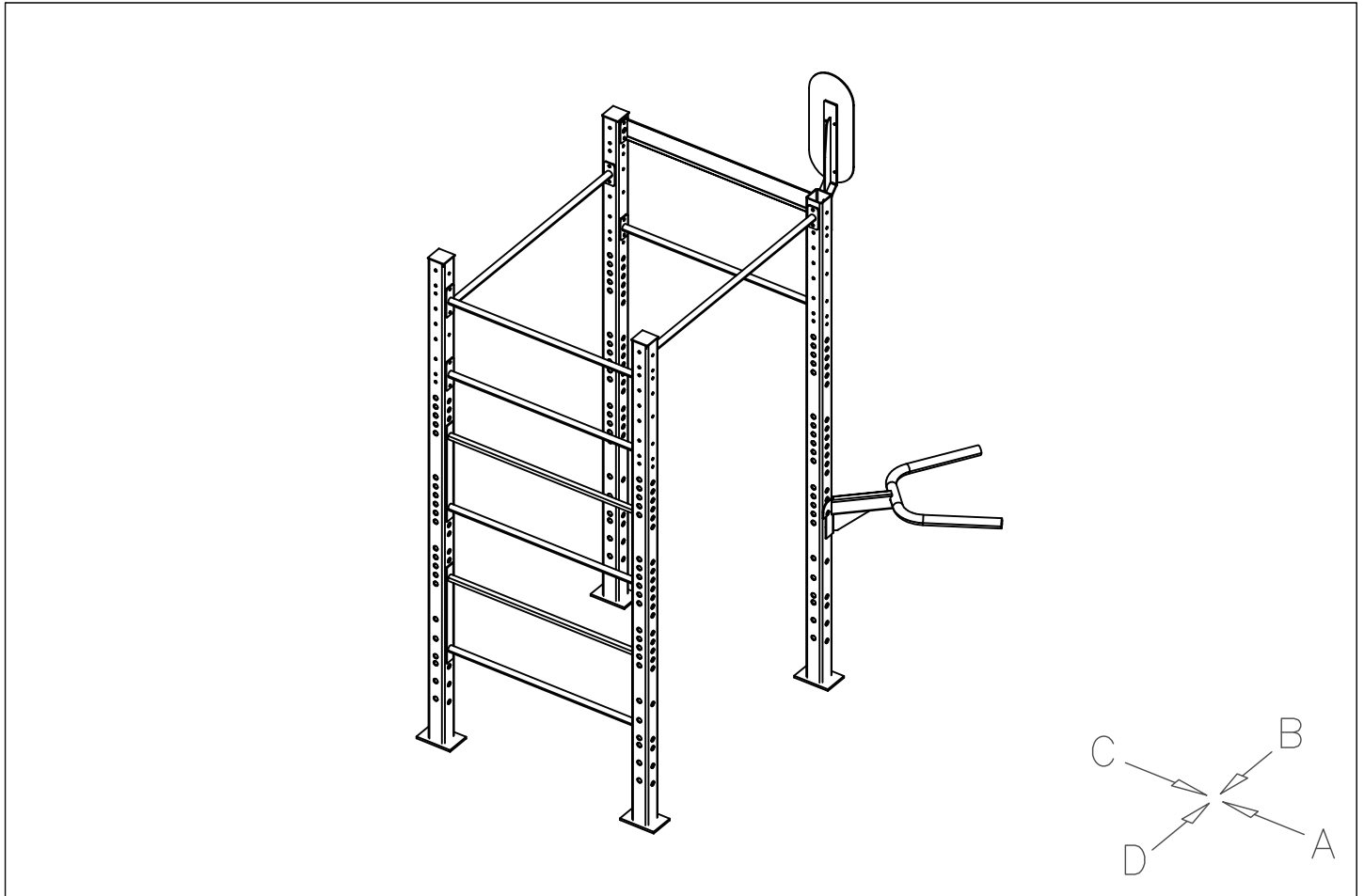

DATE: 4.1.2021

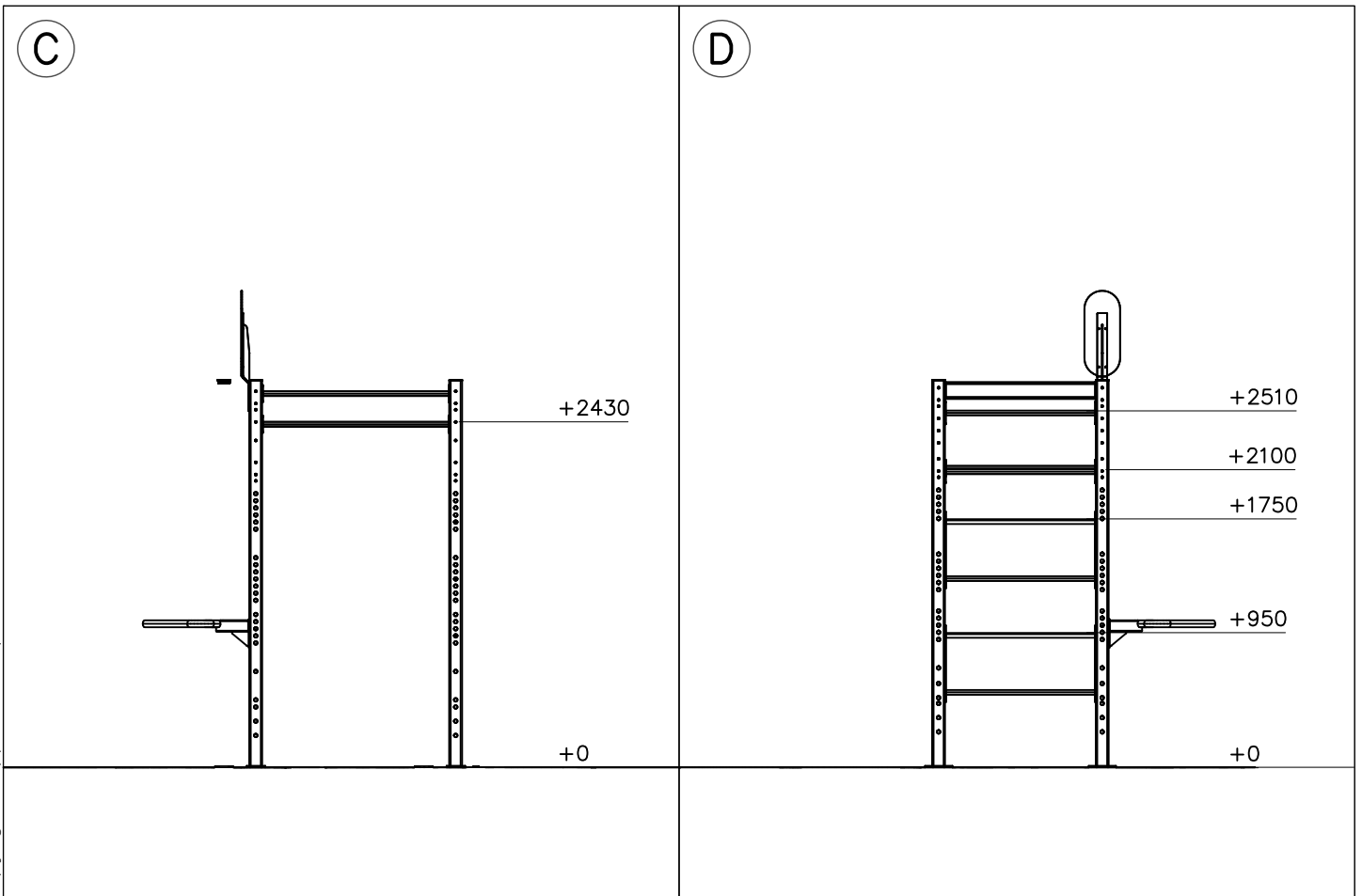
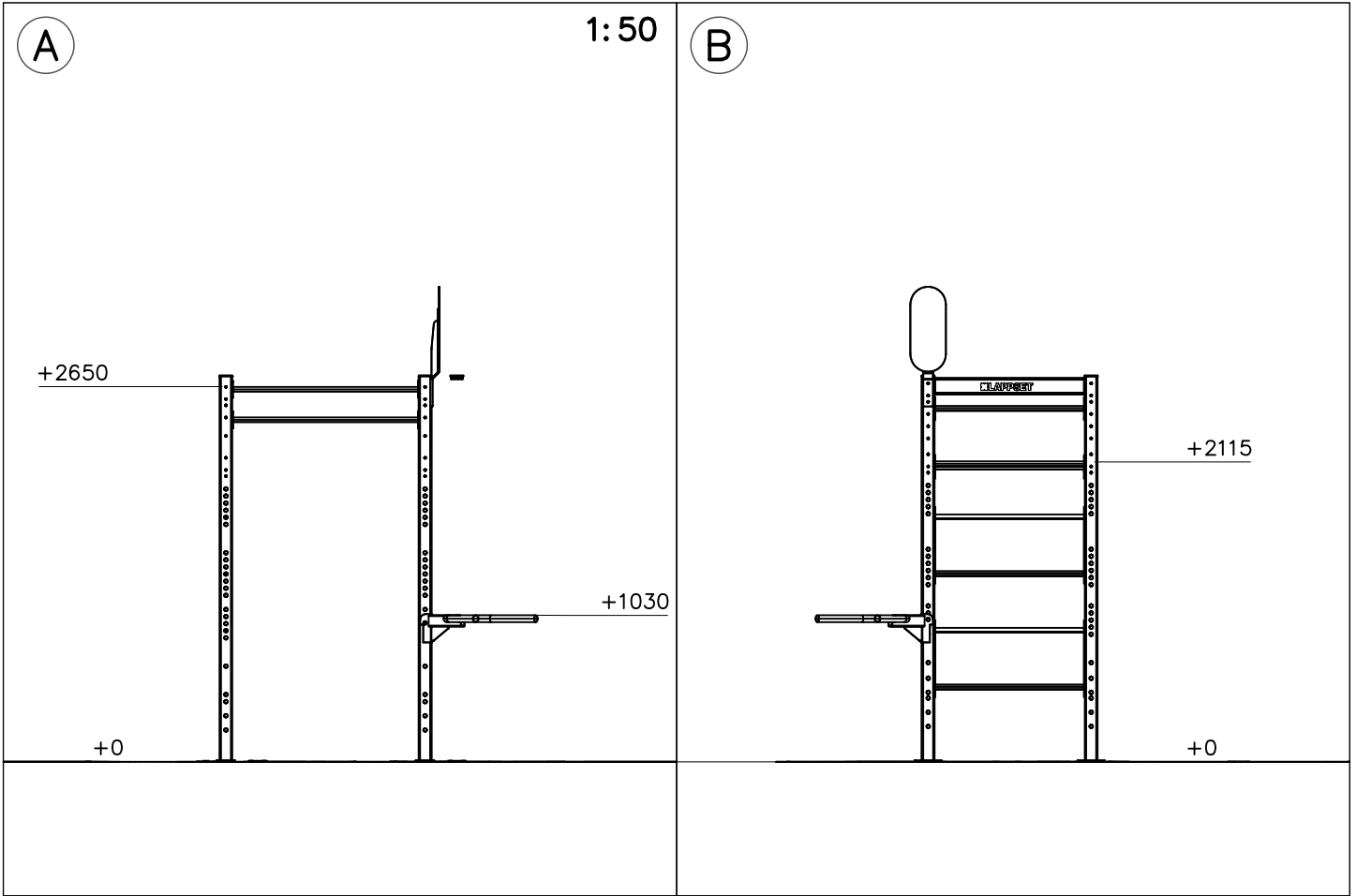

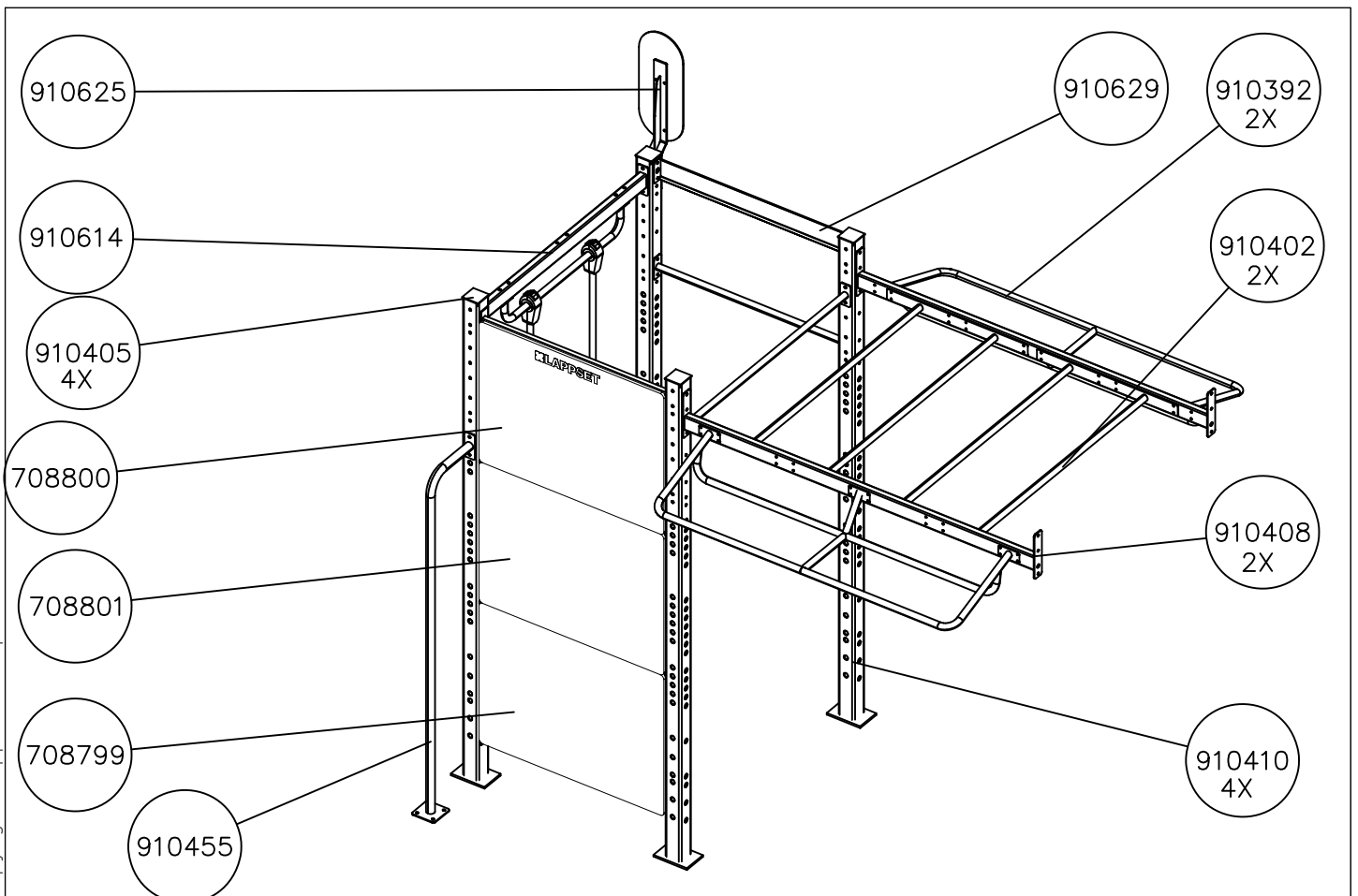
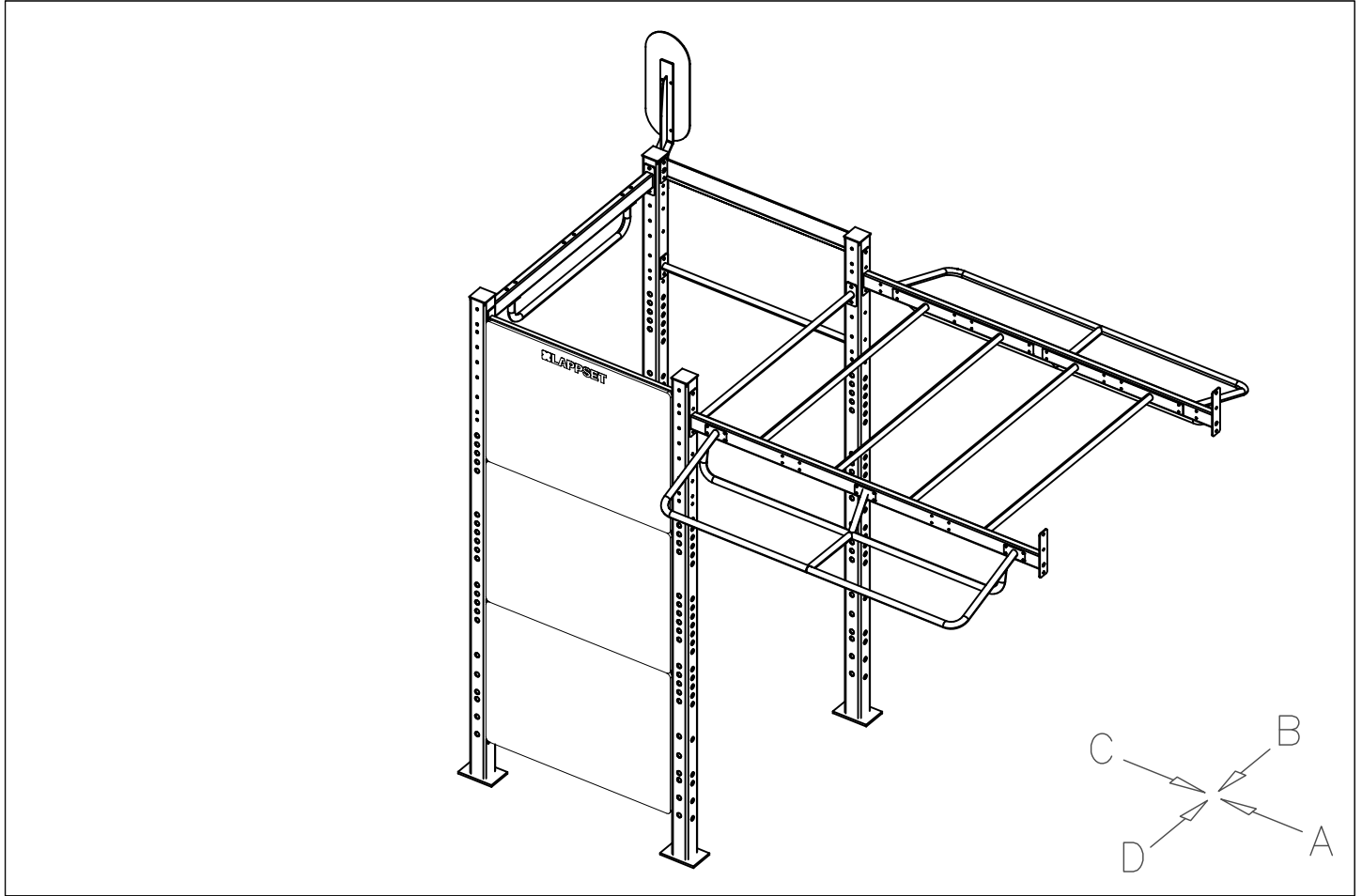

DATE: 4.1.2021

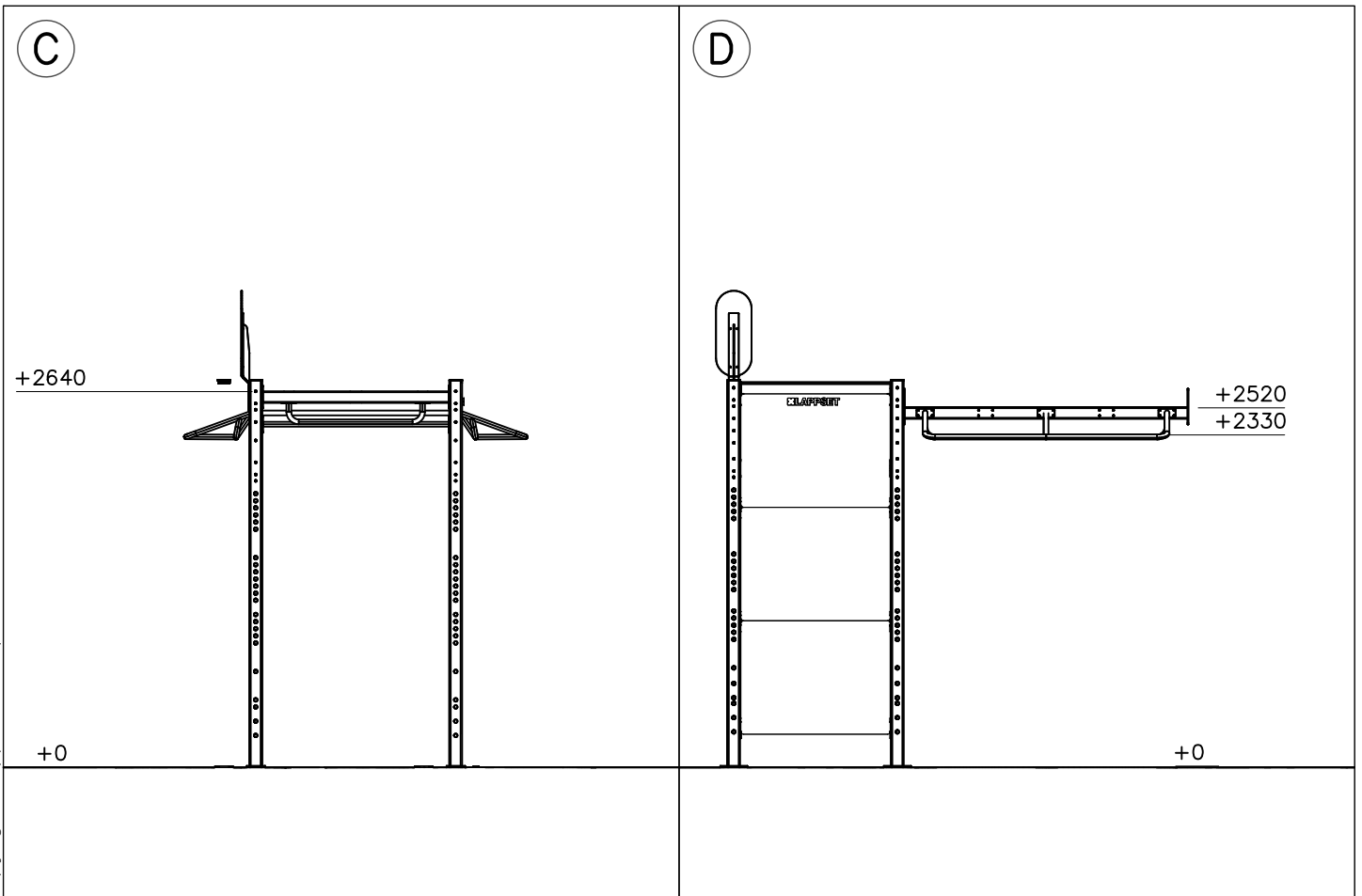
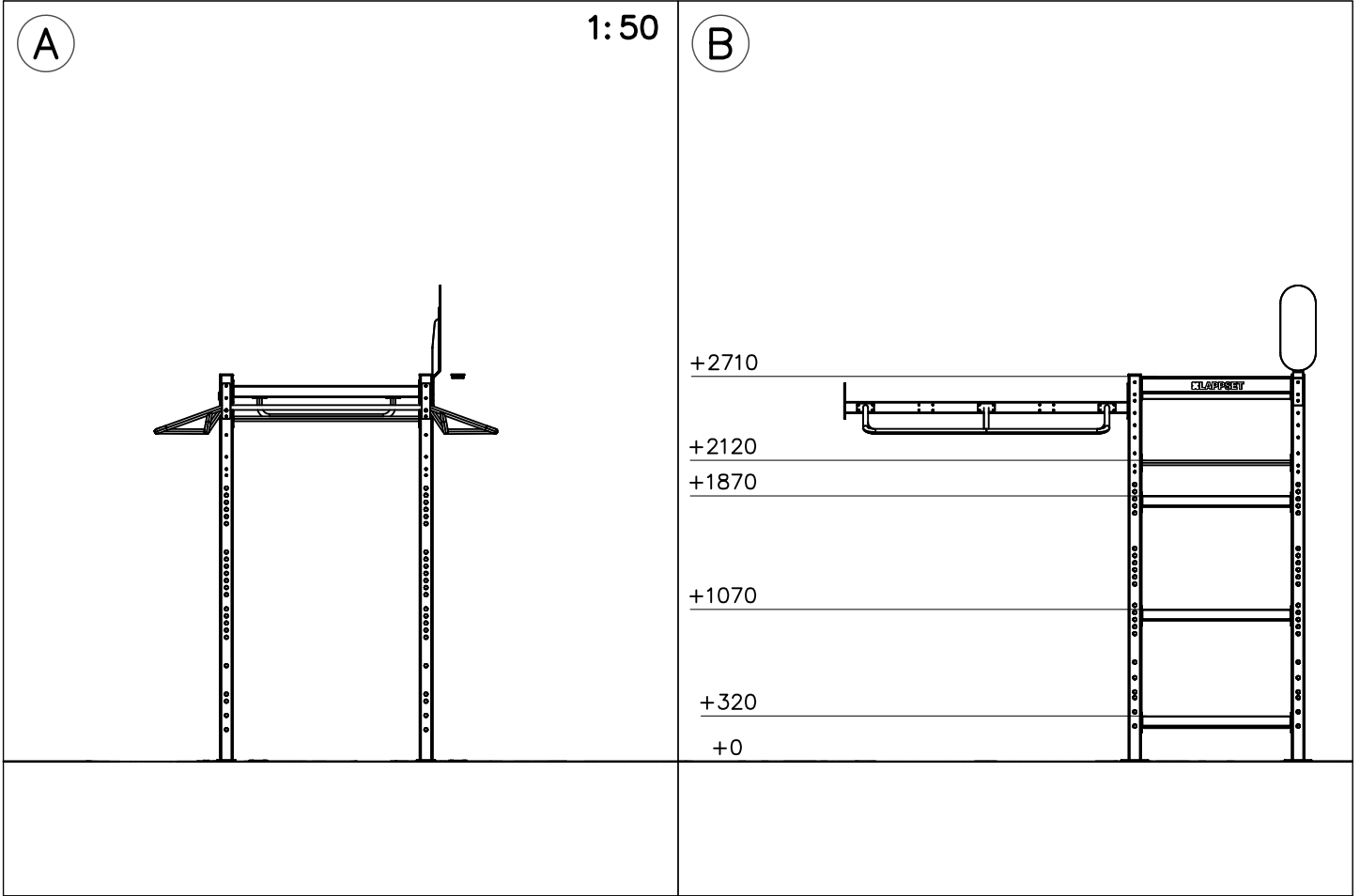

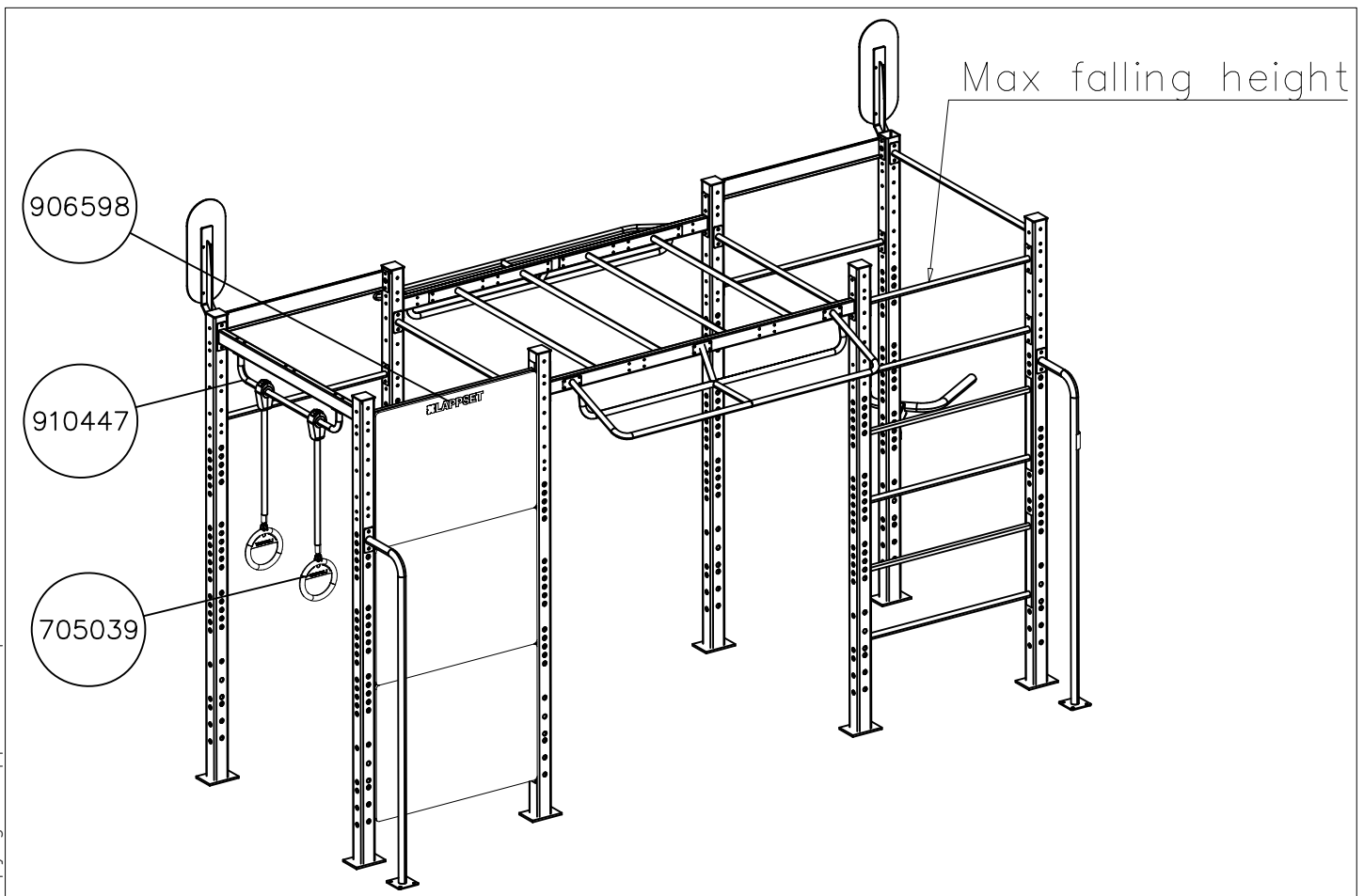
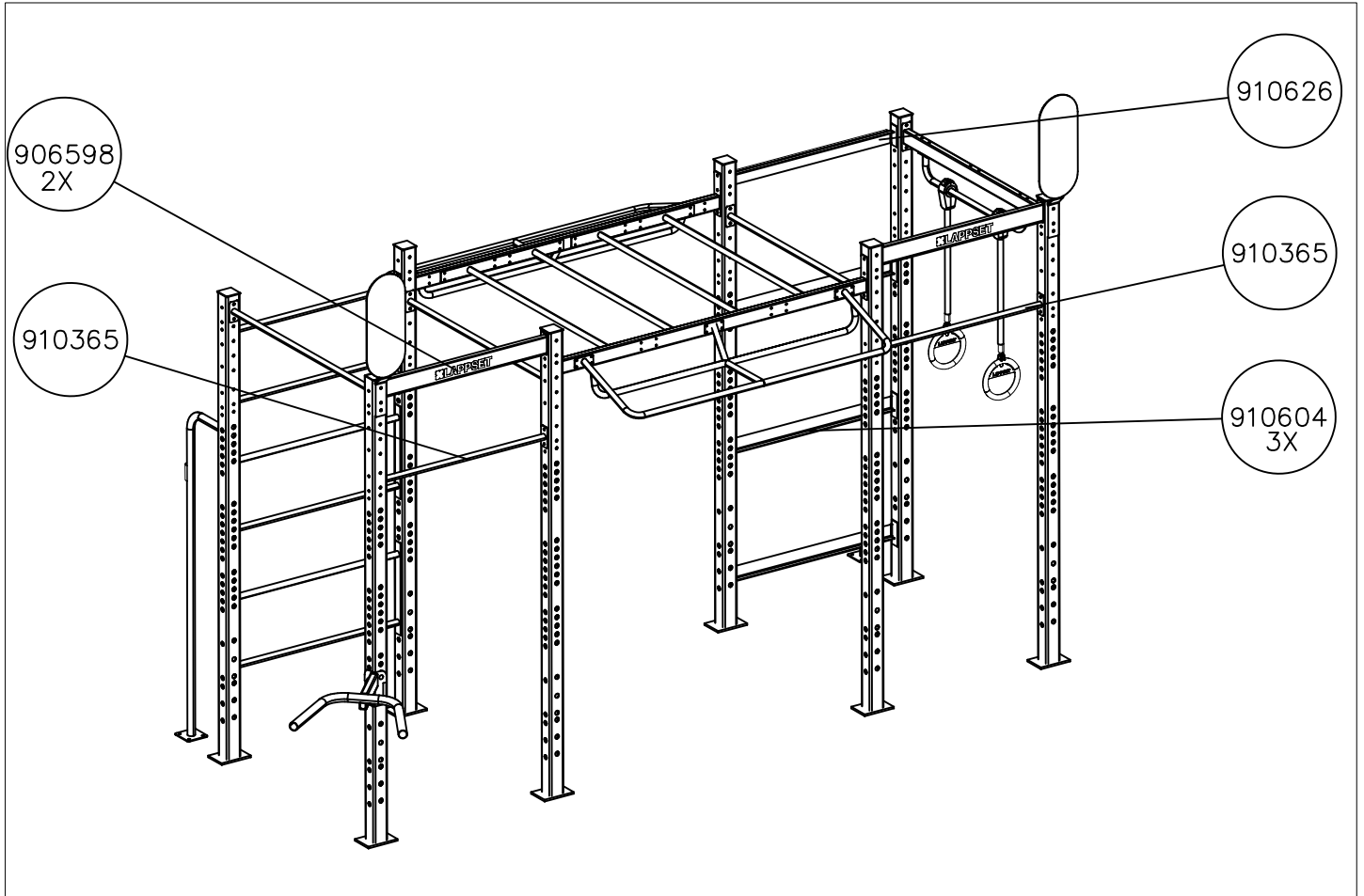

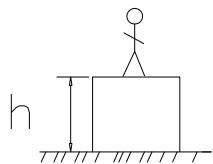

$h < 1000$

Totally hard surfaces or materials with very limited impact attenuating properties.

Totally hard surfaces.
E.g. concrete or asphalt



Case by case risk assessment is needed including e.g. evaluation whether there is forced movement, what is the intended exercise and where will the product be installed.

Materials with very limited impact attenuating properties.
E.g. wood



$h < 1200$

Materials with significant impact attenuating properties.

fine gravel 0–8 mm

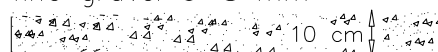

Unsorted sand/ topsoil

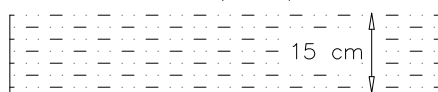

$h < 1500$

Lawn



$h < 3000$

Loose fill material

E.g.
sand/gravel 0,25...8 mm $D_{60}/D_{10} < 3,0$
Woodchips 5...30 mm
bark 20...80 mm

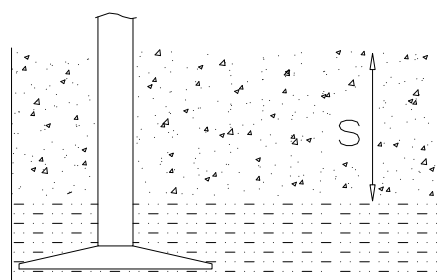

\underline{S}	\underline{h}
30 cm	$< 2,0$ m
40 cm	$< 3,0$ m

Syntetic granulates

\underline{S}	\underline{h}
40 mm	$\sim > 1,2...1,3$ m
50 mm	$\sim > 1,5...1,7$ m
60 mm	$\sim > 1,8...2,0$ m
70 mm	$\sim > 2,1...2,5$ m

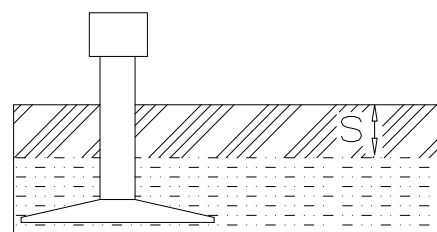

Note. For accurate values, see manufacturer's instructions.

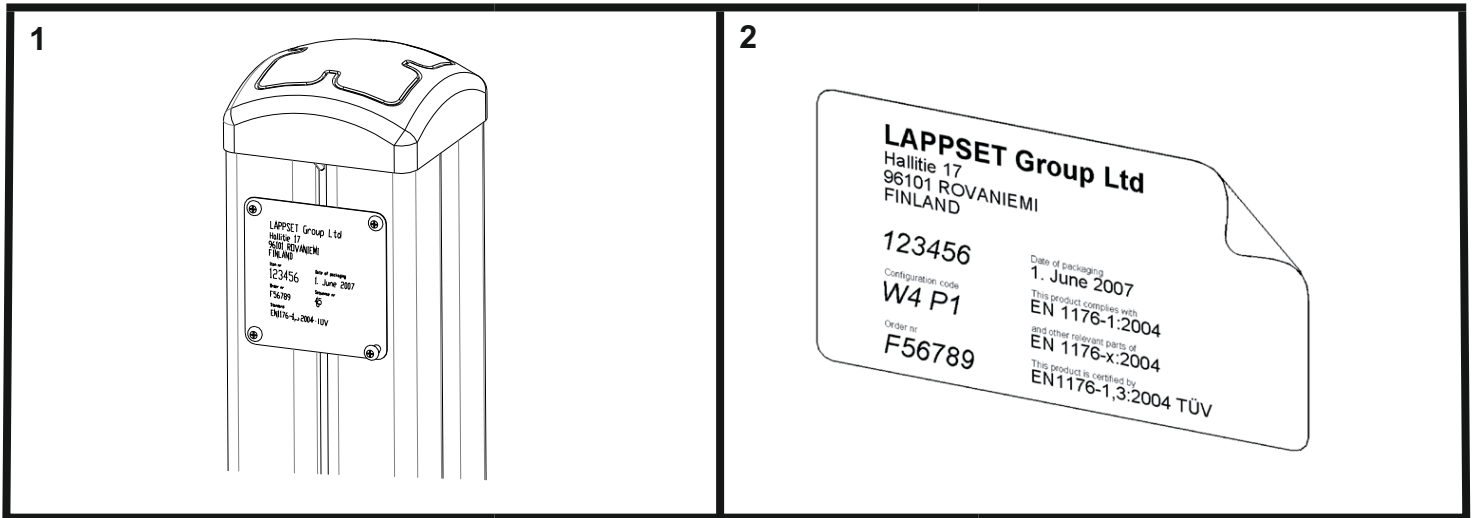

Tuotekyltti tulee tuotteen mukana yhdellä seuraavista tavoista:

1) Metallinen tuotekyltti ja kiinnitysruuvit

- Kiinnitä tuotekyltti ruuveilla tolppaan noin 2 metrin korkeuteen kuvan 2 mukaisesti.

2) Tuotekylttitarra

- Puhdista maalattu metalli- tai vaneripinta pölystä ja kosteudesta. Liimaa tarra kuvan 3 mukaisesti.
- Huom. Älä kiinnitä tarraa karheapintaiseen laminaattiin tai maalattuun puuhun.

Vår produktmärkning levereras på ett av följande sätt:

1) Produktskylt i metall

- Fäst skylten med de medföljande skruvarna

2) Självhäftande produktetikett

- Rengördenpulverlackerademetallytanellerlaminatytansåttndenblirfrifrånsmutsochfukt.Fästetikettenenligtfig.3.
- Obs! Fäst ej etiketten på detaljer med skrovlig yta eller på målat trä.

Product label is delivered by one of following ways:

1) Metal product label and screws

- Fasten the label with screws.

2) Label sticker

- Cleanthepaintedmetalorplywoodsurfacefromdirtandmoisture.Fastenthestickerasshowninthefigure3.
- Note. Do not attach the sticker to rough surfaced laminate or painted wood.

La plaque d'informations produit est livrée sous l'une de ces 3 formes :

1) Plaque métallique et vis

- Fixez la plaque à l'aide des vis.

2) Etiquette autocollante

- Avant de coller l'étiquette, nettoyez le composant métallique peint ou la plaque de contreplaqué, de toute saleté. La surface doit être sèche (voir image 3).
- Attention, ne pas coller l'étiquette sur une surface lamellé-collée irrégulière ou sur du bois peint.

Die Auslieferung des Produktaufklebers erfolgt auf eine dieser Arten:

1) Produkt-Schild aus Metall incl. Schrauben

- Die Befestigung des Schildes erfolgt mittels der Schrauben.

2) Aufkleber

- EntfernenSiezunächstSchmutzundFeuchtigkeitvomlackiertenMetallbzw.vonderHolzoberflächeundbringenSiedenAufkleber wie im Bild oben rechts beschrieben auf den gesäuberten Untergrund auf.
- Beachten Sie: Bringen Sie den Aufkleber nicht auf raues laminiertes oder lackiertes Holz an.