

LAPPSET®

FITNESS

ASENNUSOHJE
MONTERINGSANSVISNING
INSTALLATION INSTRUCTION
AUFBAUANLEITUNG
NOTICE D'INSTALLATION

DATE: 4.1.2021







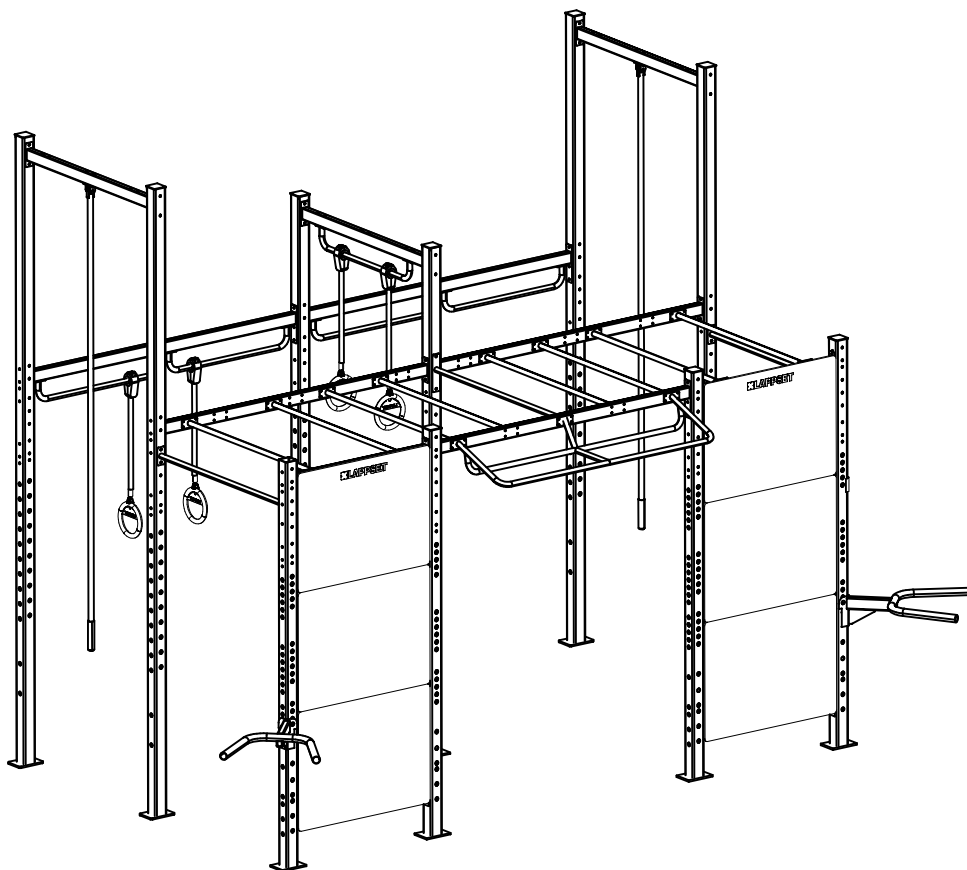





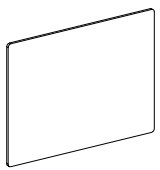
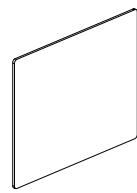
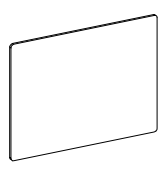

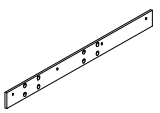
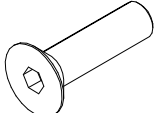

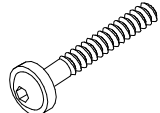
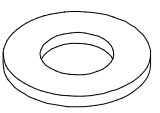
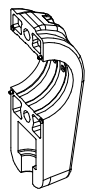
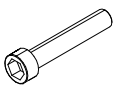

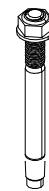
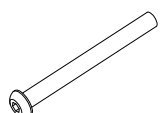
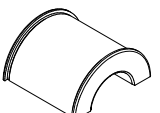

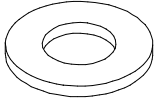
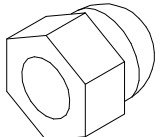
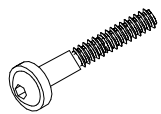
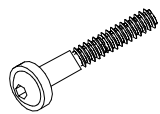
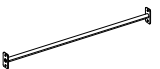
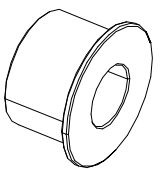
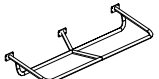
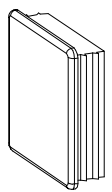
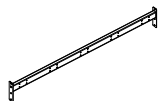
Fitness equipment is not intended for installation in the immediate vicinity of children's playgrounds in accordance with EN 1176.

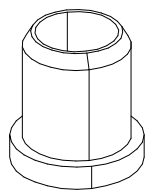
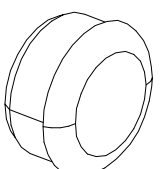
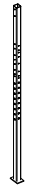
Kuntolaitteita ei ole tarkoitettu asennettaviksi lasten leikkikentän välittömään läheisyyteen standardin EN 1176 mukaisesti.

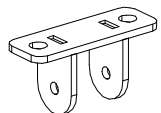
081857

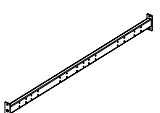
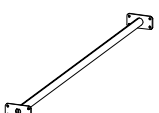

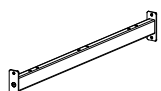
DATE: 4.1.2021

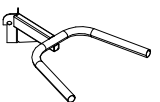
<p>702341</p>  <p>90x50</p>	PCS 1	<p>705039</p>  <p>Ø16x974</p>	PCS 4	<p>708799-704</p>  <p>15x1050x798</p>	PCS 2	<p>708800-704</p>  <p>15x1050x798</p>	PCS 2	<p>708801-704</p>  <p>15x1050x798</p>	PCS 2	<p>708811</p>  <p>Ø32x3050</p>	PCS 2
<p>709293-704</p>  <p>10x68x1050</p>	PCS 2	<p>900348</p>  <p>M8x30</p>	PCS 40	<p>900735</p>  <p>M8x60</p>	PCS 56	<p>900965</p>  <p>M10</p>	PCS 104	<p>901104</p>  <p>M8x80</p>	PCS 8	<p>901302</p>  <p>Ø20/10.5x2</p>	PCS 164
<p>902195</p>  <p>150x50x50</p>	PCS 8	<p>902232</p>  <p>M10x55</p>	PCS 4	<p>902233</p>  <p>M10x30</p>	PCS 4	<p>904450</p>  <p>M16x170</p>	PCS 40	<p>904917</p>  <p>M10x100</p>	PCS 24	<p>906006</p>  <p>Ø64/36,4x59</p>	PCS 8
<p>906598</p>  <p>366x50</p>	PCS 2	<p>909256</p>  <p>Ø16/8.4</p>	PCS 266	<p>909633</p>  <p>M8</p>	PCS 118	<p>909866</p>  <p>M8x60</p>	PCS 12	<p>909867</p>  <p>M8x70</p>	PCS 2	<p>910368-217</p>  <p>1315</p>	PCS 2
<p>910376</p>  <p>Ø30x17</p>	PCS 56	<p>910392-217</p> 	PCS 1	<p>910405</p>  <p>90x90x30</p>	PCS 10	<p>910408-207</p> 	PCS 1	<p>910410-207</p>  <p>90x90x2720</p>	PCS 4	<p>910415</p>  <p>Ø16/12,5-14x17</p>	PCS 257
<p>910416</p>  <p>Ø48/43-45x24</p>	PCS 4	<p>910427-207</p>  <p>90x90x3400</p>	PCS 2	<p>910447-217</p> 	PCS 5	<p>910448-207</p>  <p>110x38x55</p>	PCS 2	<p>910604-207</p>  <p>1060</p>	PCS 6	<p>910606-207</p>  <p>90x90x4200</p>	PCS 4
<p>910608-207</p>  <p>2105</p>	PCS 2	<p>910609-217</p>  <p>1365</p>	PCS 8	<p>910612-217</p>  <p>1340</p>	PCS 1	<p>910614-207</p>  <p>1315</p>	PCS 3	<p>910616-207</p>  <p>2105</p>	PCS 2	<p>910619-217</p>  <p>45°</p>	PCS 2

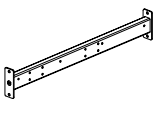
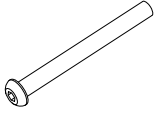
<p>910621-207</p>  <p>1060</p>	<p>PCS</p> <p>2</p>	<p>911149</p>  <p>M10x110</p>	<p>PCS</p> <p>72</p>		<p>PCS</p>		<p>PCS</p>		<p>PCS</p>		<p>PCS</p>
	PCS		PCS		PCS		PCS		PCS		PCS
	PCS		PCS		PCS		PCS		PCS		PCS
	PCS		PCS		PCS		PCS		PCS		PCS
	PCS		PCS		PCS		PCS		PCS		PCS
	PCS		PCS		PCS		PCS		PCS		PCS
	PCS		PCS		PCS		PCS		PCS		PCS

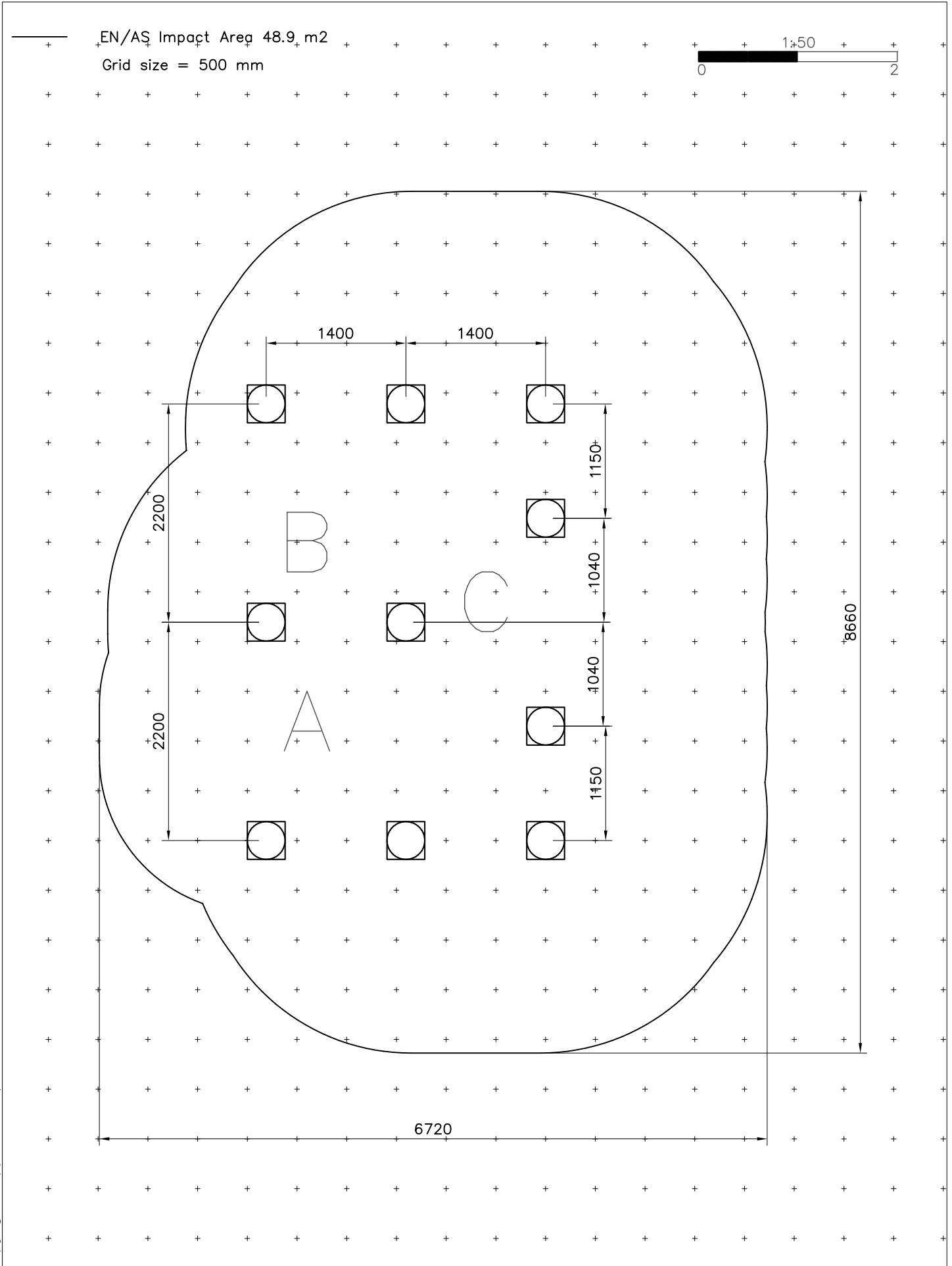

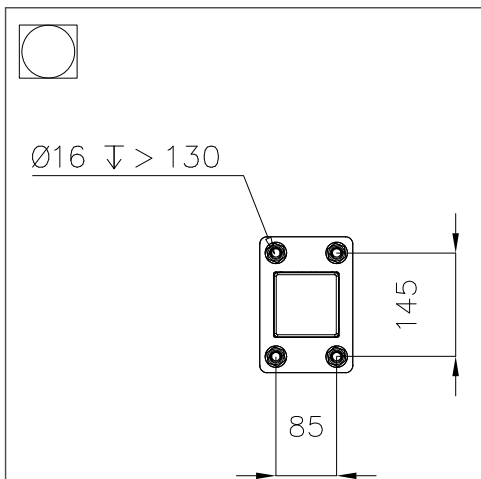
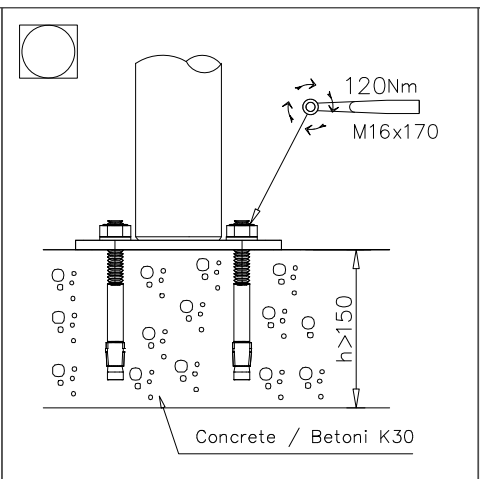
 <p>Ø16 \downarrow > 130</p> <p>145</p> <p>85</p>	 <p>120Nm</p> <p>M16x170</p> <p>h > 150</p> <p>Concrete / Betoni K30</p>	

Concrete foundation plans

3pcs 200x500x4930

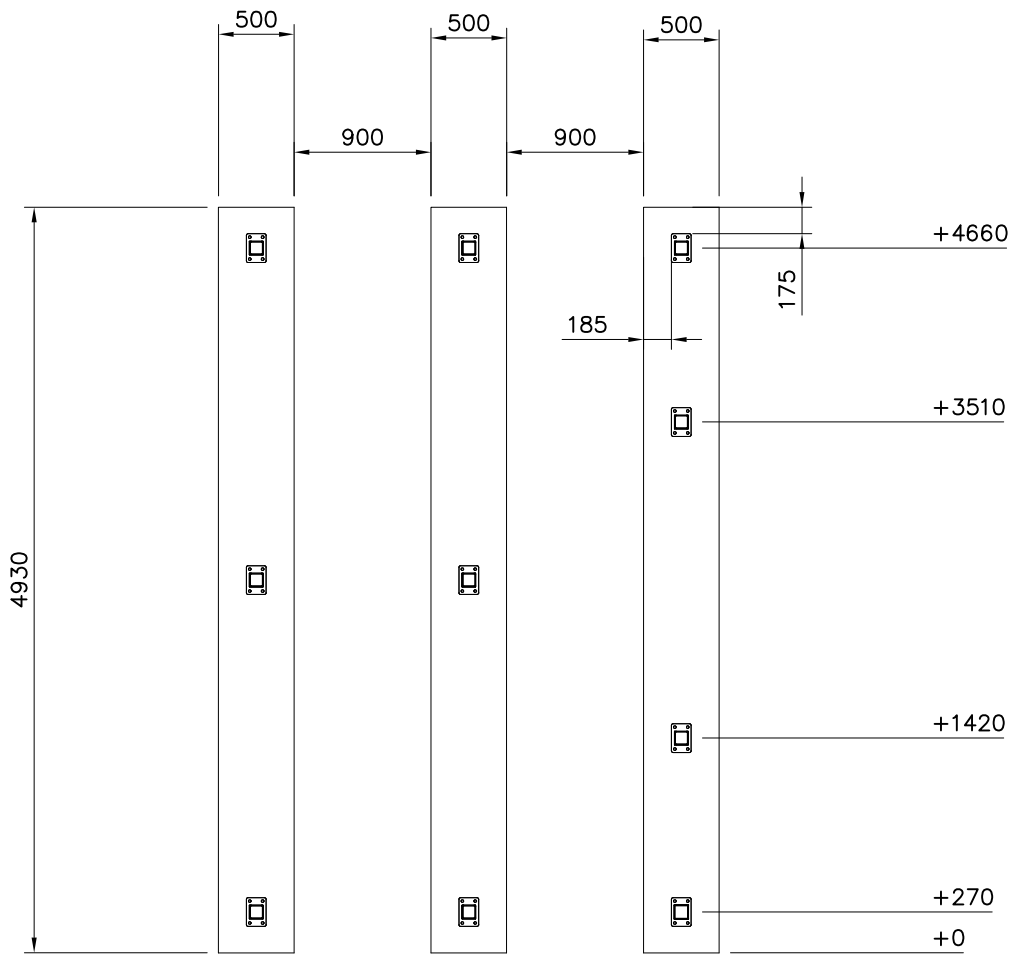

- EN/AS Impact Area 48.9 m²
 - Training Space 21.8 m²
 - - - - Falling Space 48.8 m²
- Max falling height 2750mm

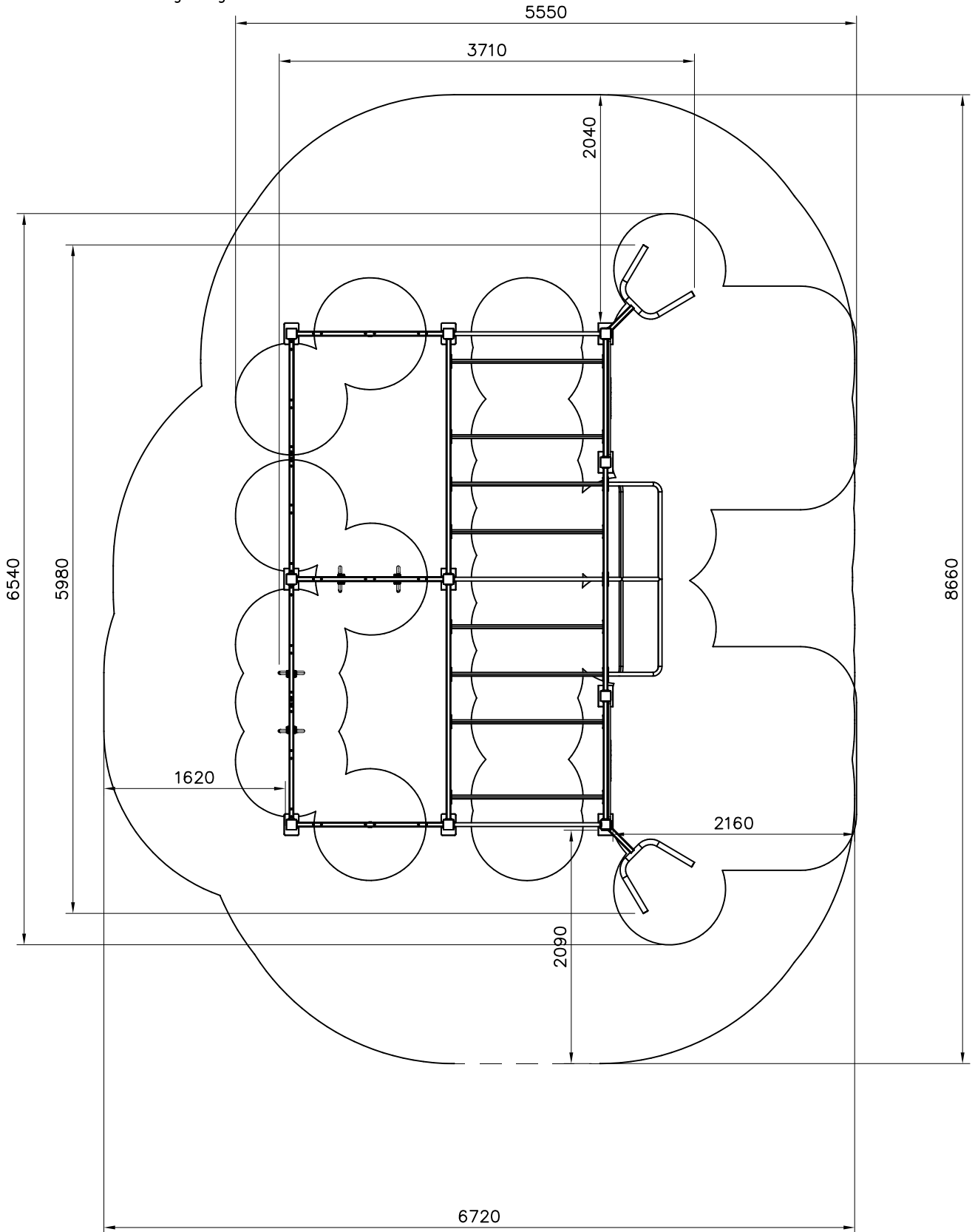
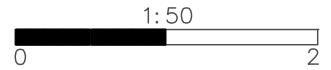

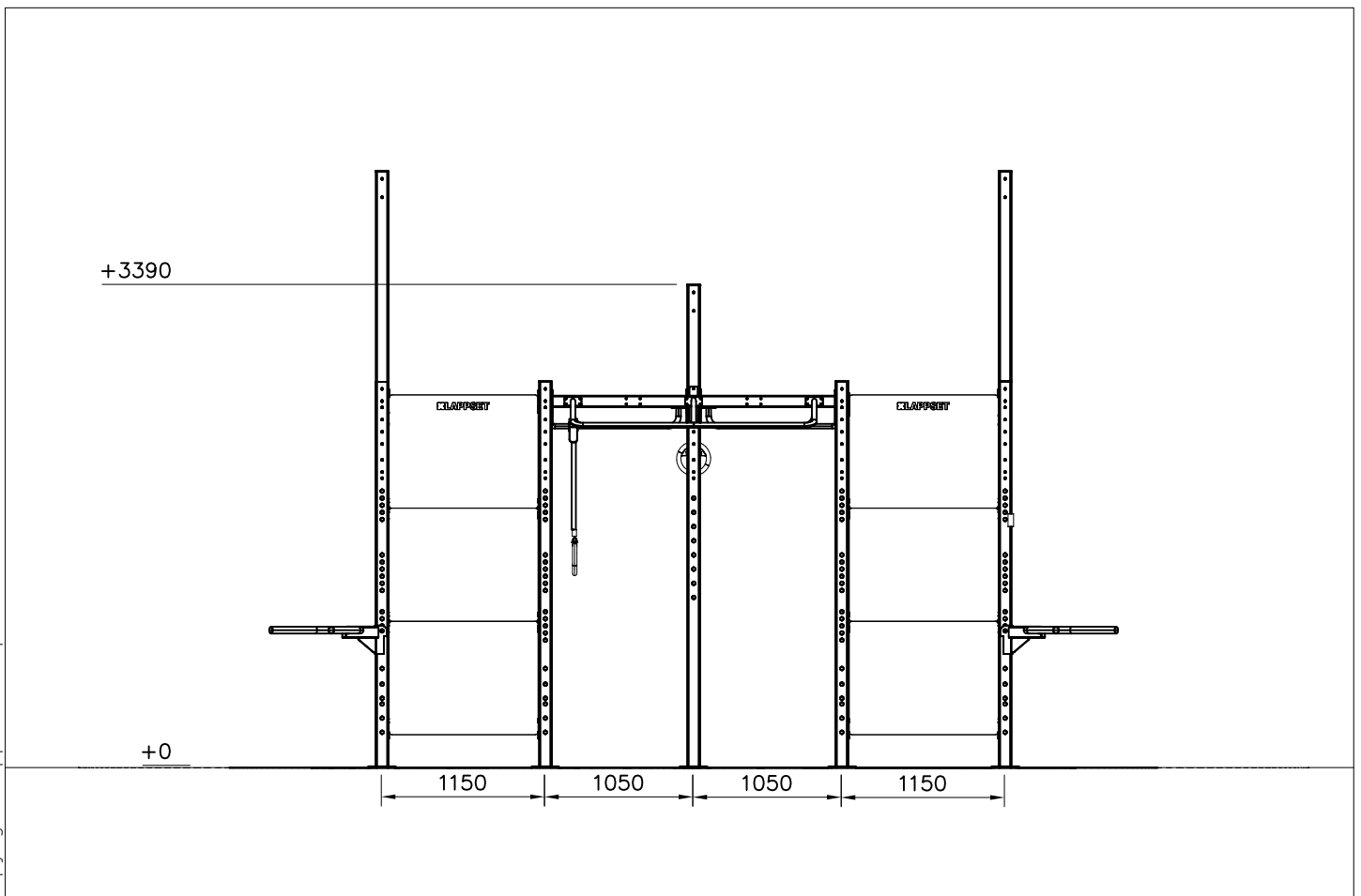
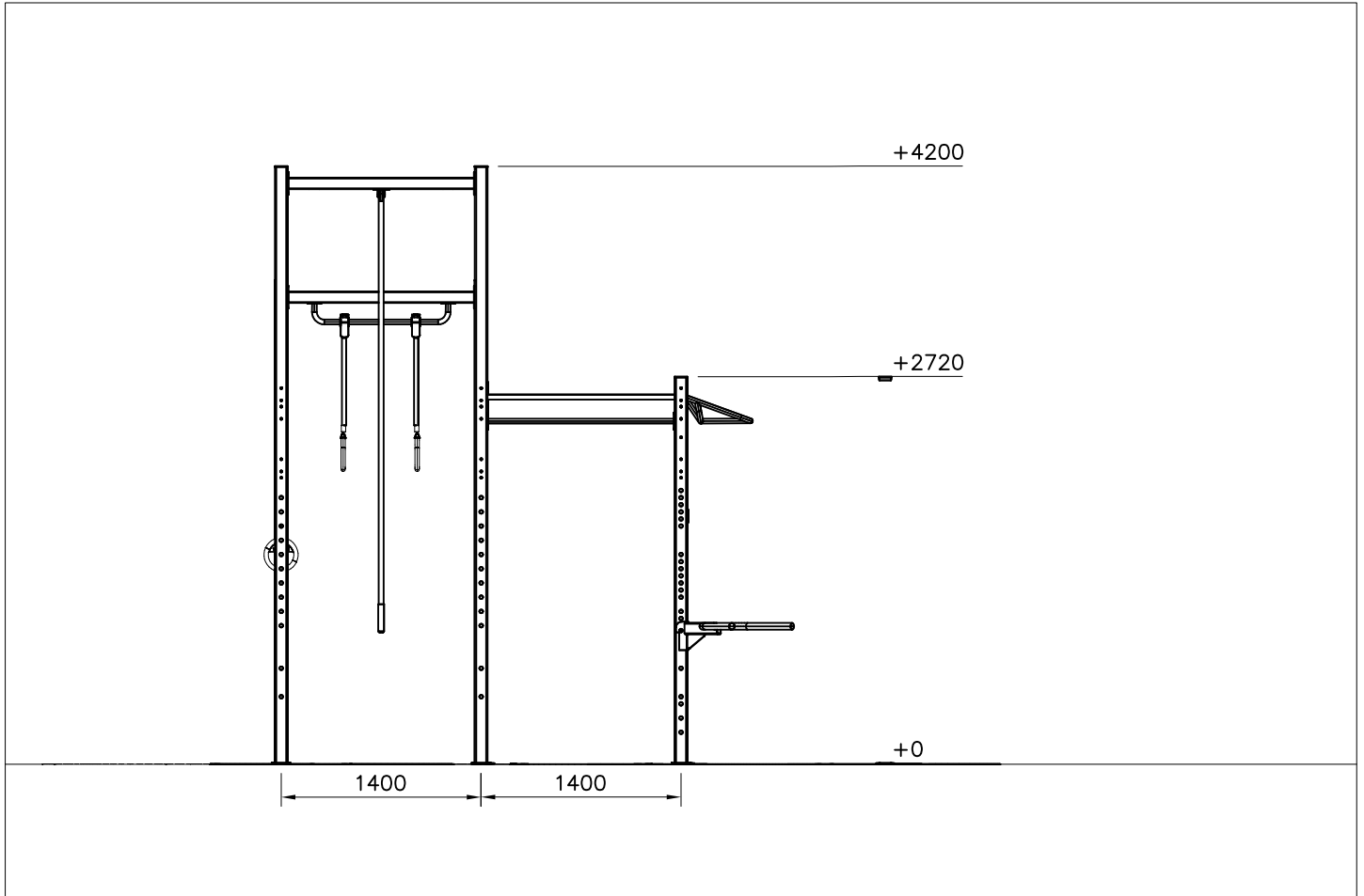

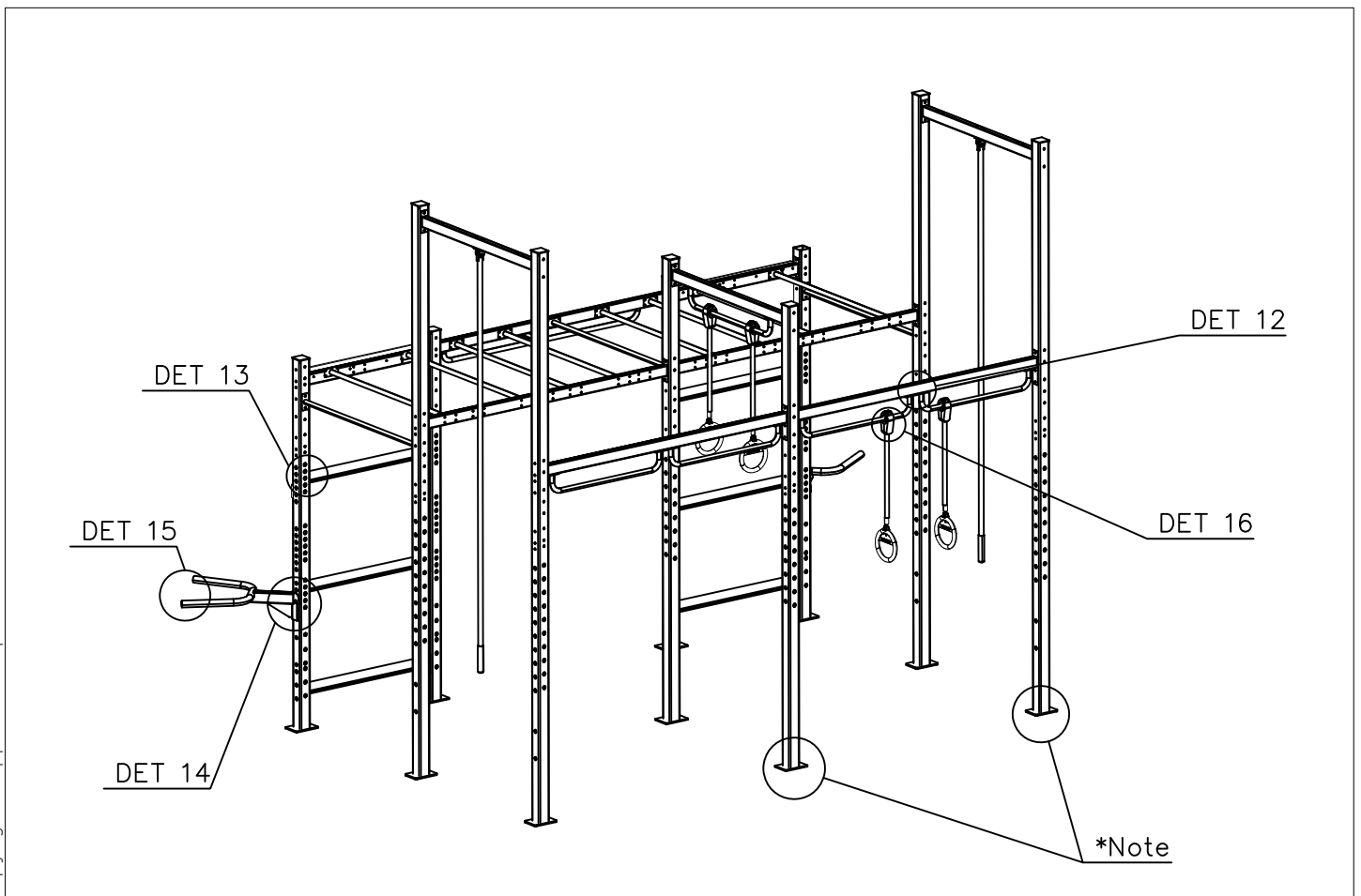
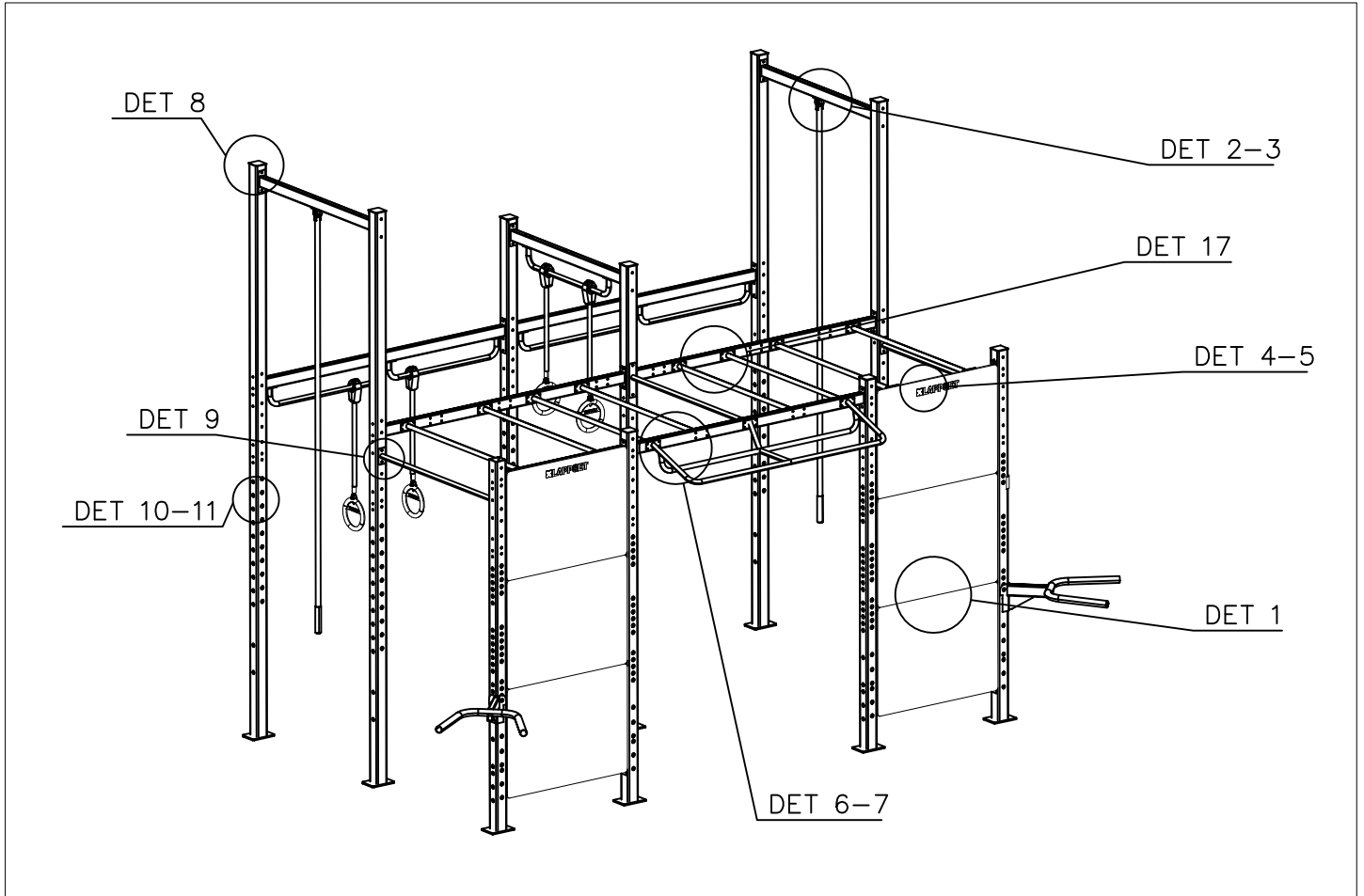

<p>DET 1</p> <p>900348 909633 909256</p>	<p>DET 2</p> <p>909633 909256 909867</p>	<p>DET 3</p> <p>900965 901302 910448 904917</p>	<p>DET 4</p> <p>909256 909633 901104</p>
<p>DET 5</p> <p>909256 909633 709293 900735</p>	<p>DET 6</p> <p>909866 909633 909256</p>	<p>DET 7</p> <p>909633 909256 909866</p>	<p>DET 8</p> <p>910405</p>
<p>DET 9</p> <p>911149 901302 900965</p>	<p>DET 10</p> <p>Plug the unused 13mm holes in the posts and beams with the plugs (910415)</p> <p>Tuki käyttämättömät 13mm reiät puomeissa ja tolpiissa tulpilla (910415)</p> <p>910415</p>	<p>DET 11</p> <p>When installing elements in the 25mm holes use the bushings (910376) on both sides of the post</p> <p>25mm reikiin asennettaessa käytä puslia (910376) tolpan molemmin puolin</p> <p>910376</p>	<p>DET 12</p> <p>900965 901302 904917</p>
<p>DET 13</p> <p>911149 910376 901302 900965</p>	<p>DET 14</p> <p>910376 901302 900965 911149</p>	<p>DET 15</p> <p>910416</p>	<p>DET 16</p> <p>902233 902232 906006 902195 900965</p>
<p>DET 17</p> <p>909256 909633 900735</p>	<p>*Note</p> <p>All the post flanges are in the same direction</p> <p>Kaikki pylväiden jalat ovat samansuuntaisesti</p>		

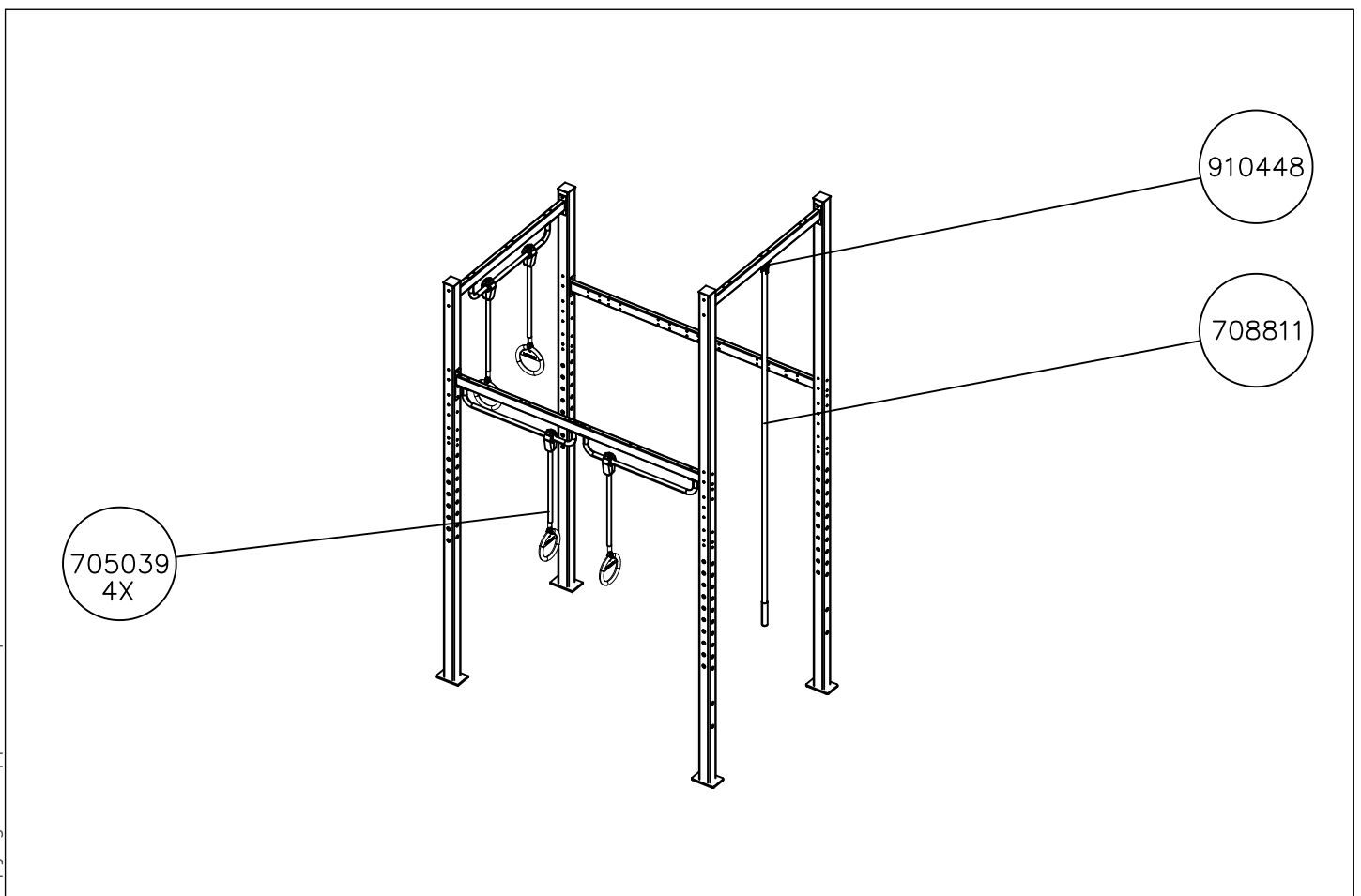
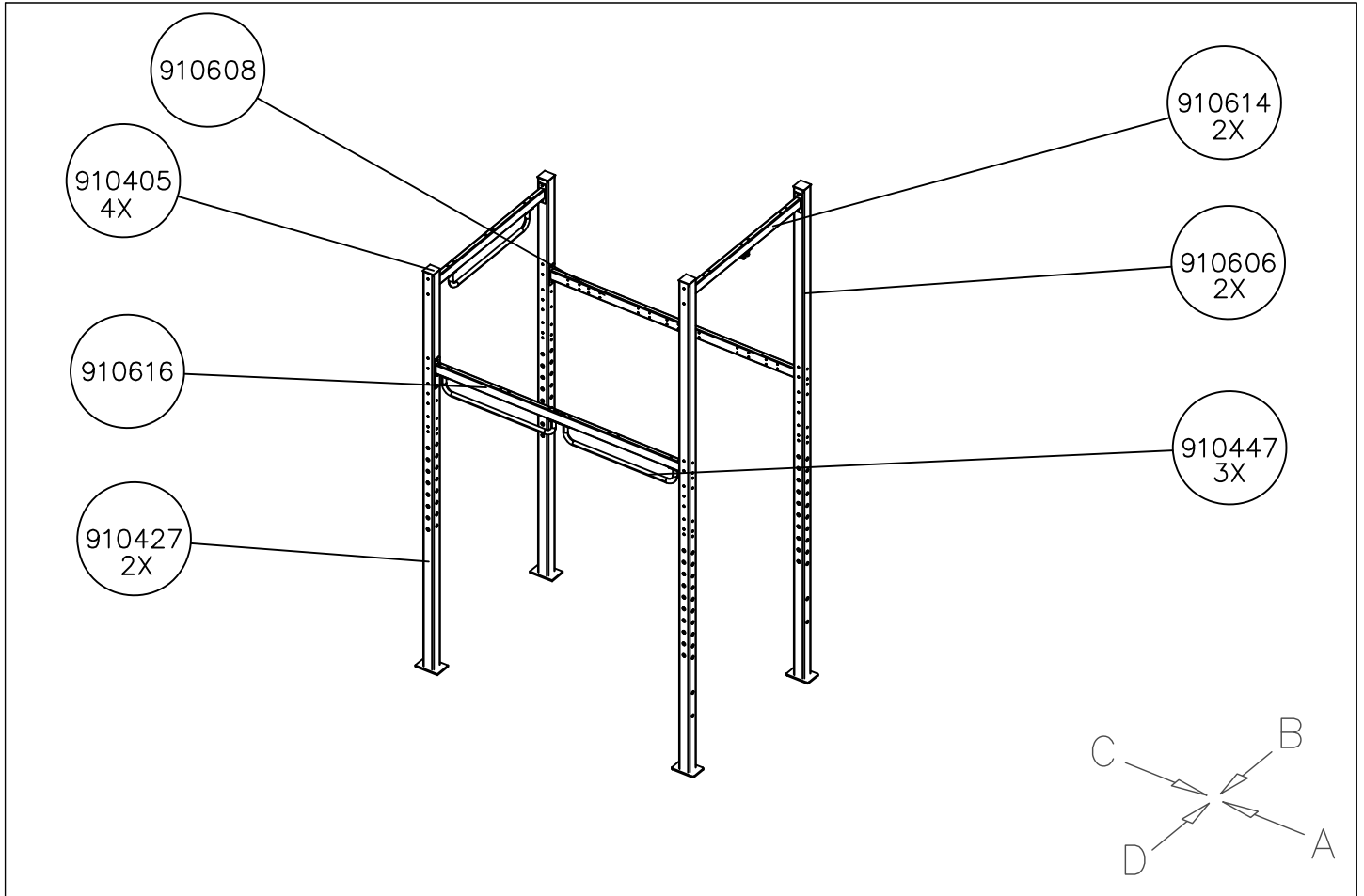

DATE: 4.1.2021

1:50

(A)

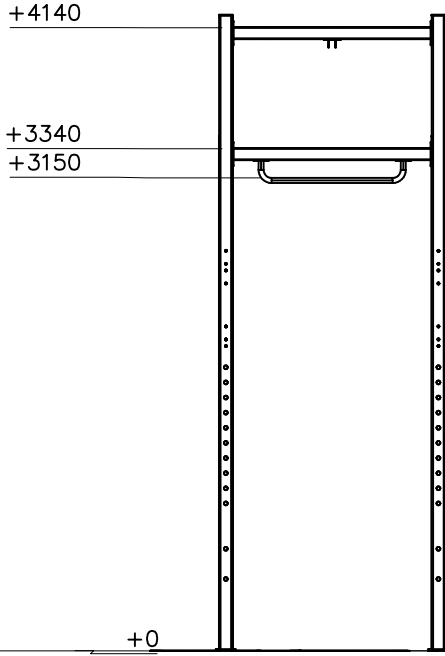

(B)

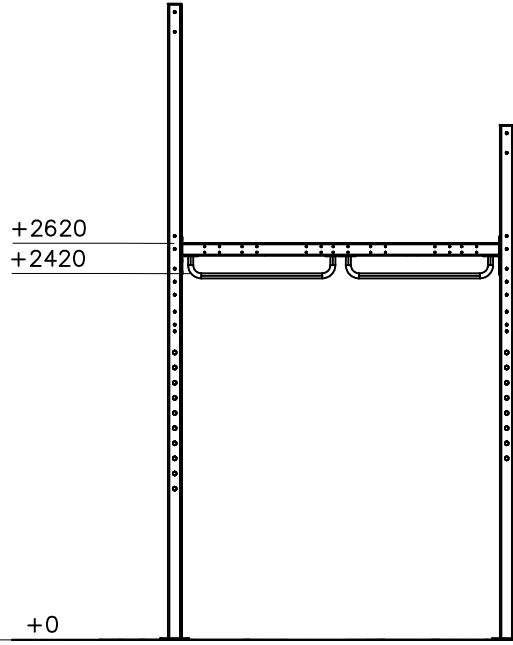

(C)

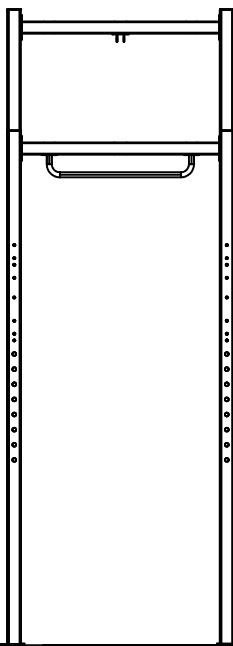

(D)

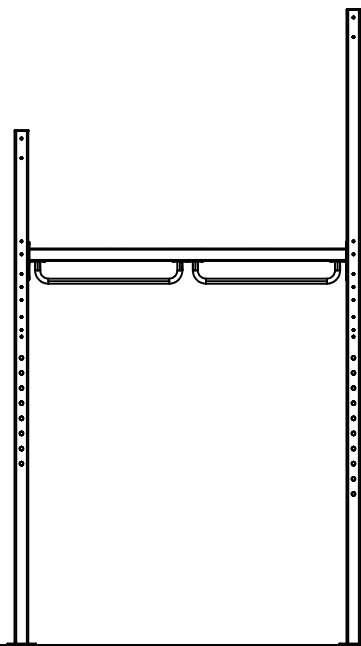

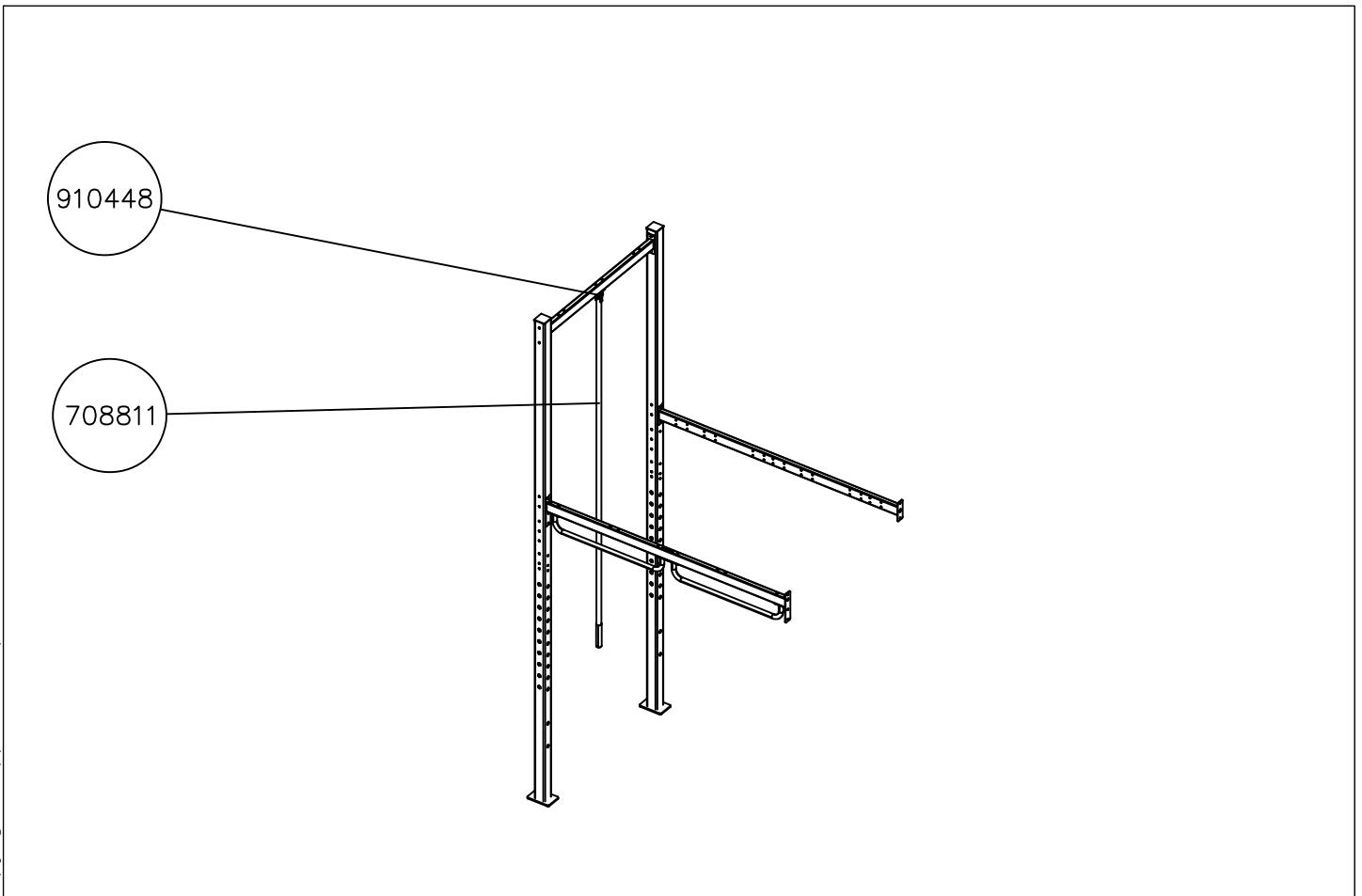
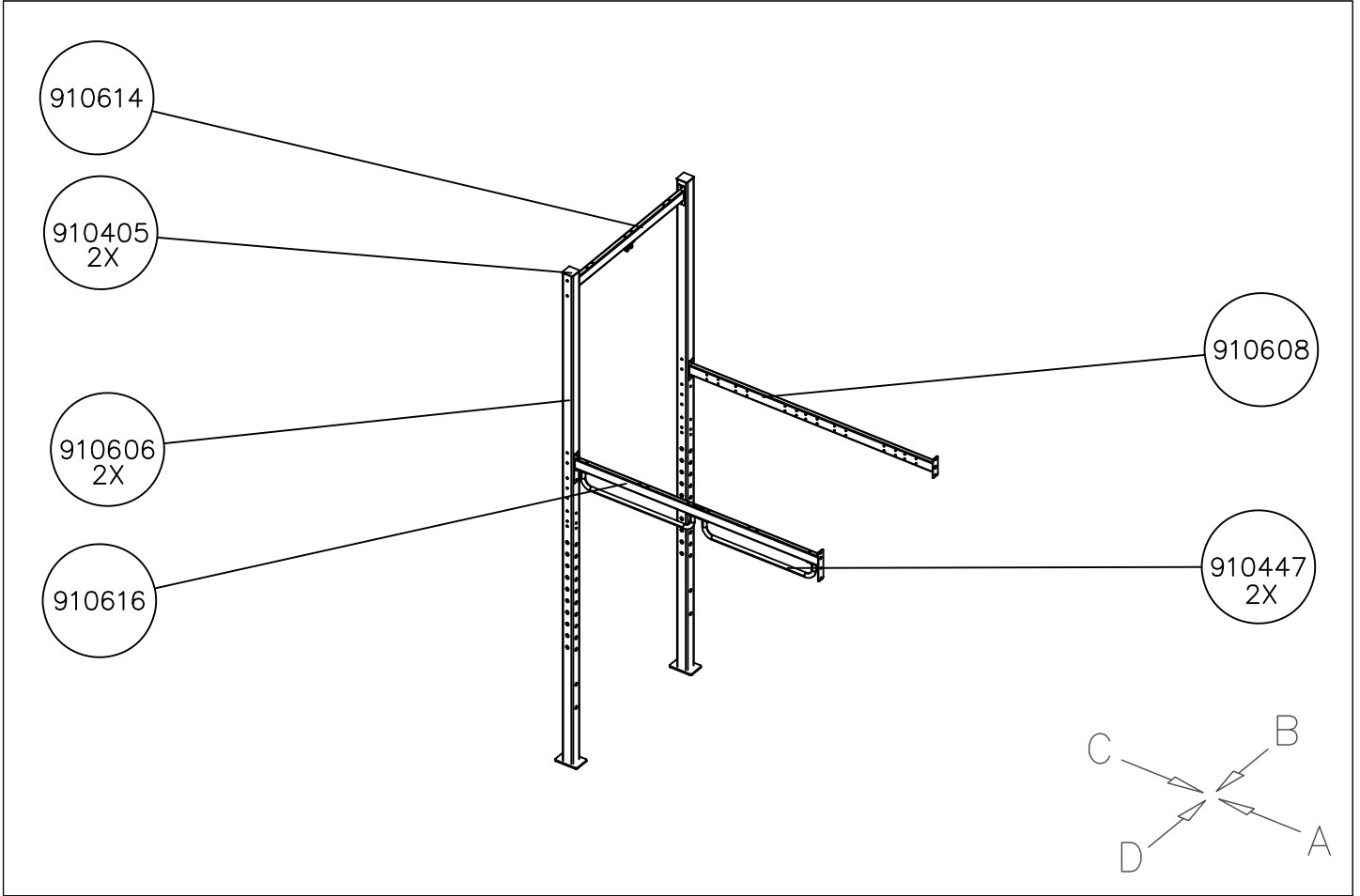

DATE: 4.1.2021

1:50

A

+4120

+0

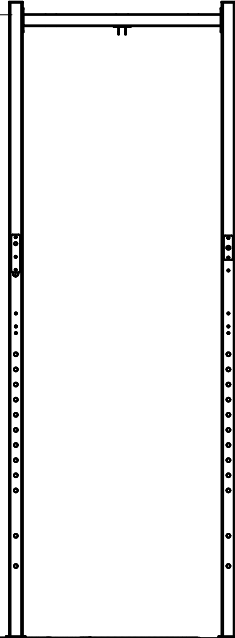

B

+2620

+2420

+0

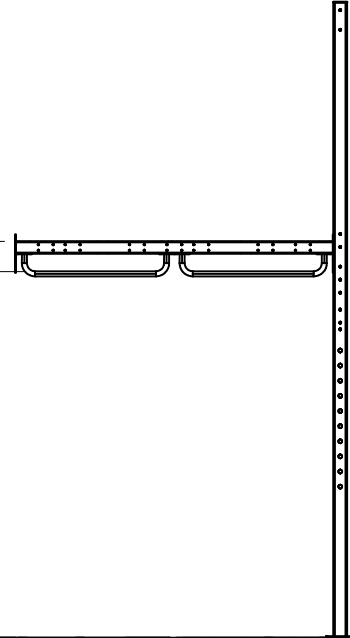

C

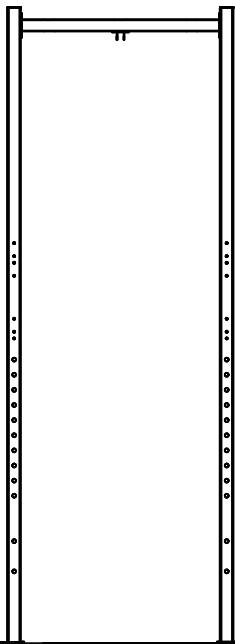

D

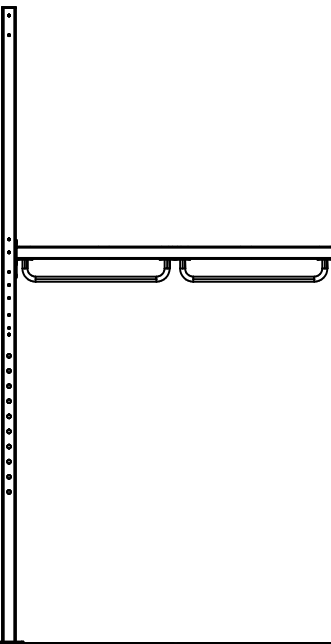

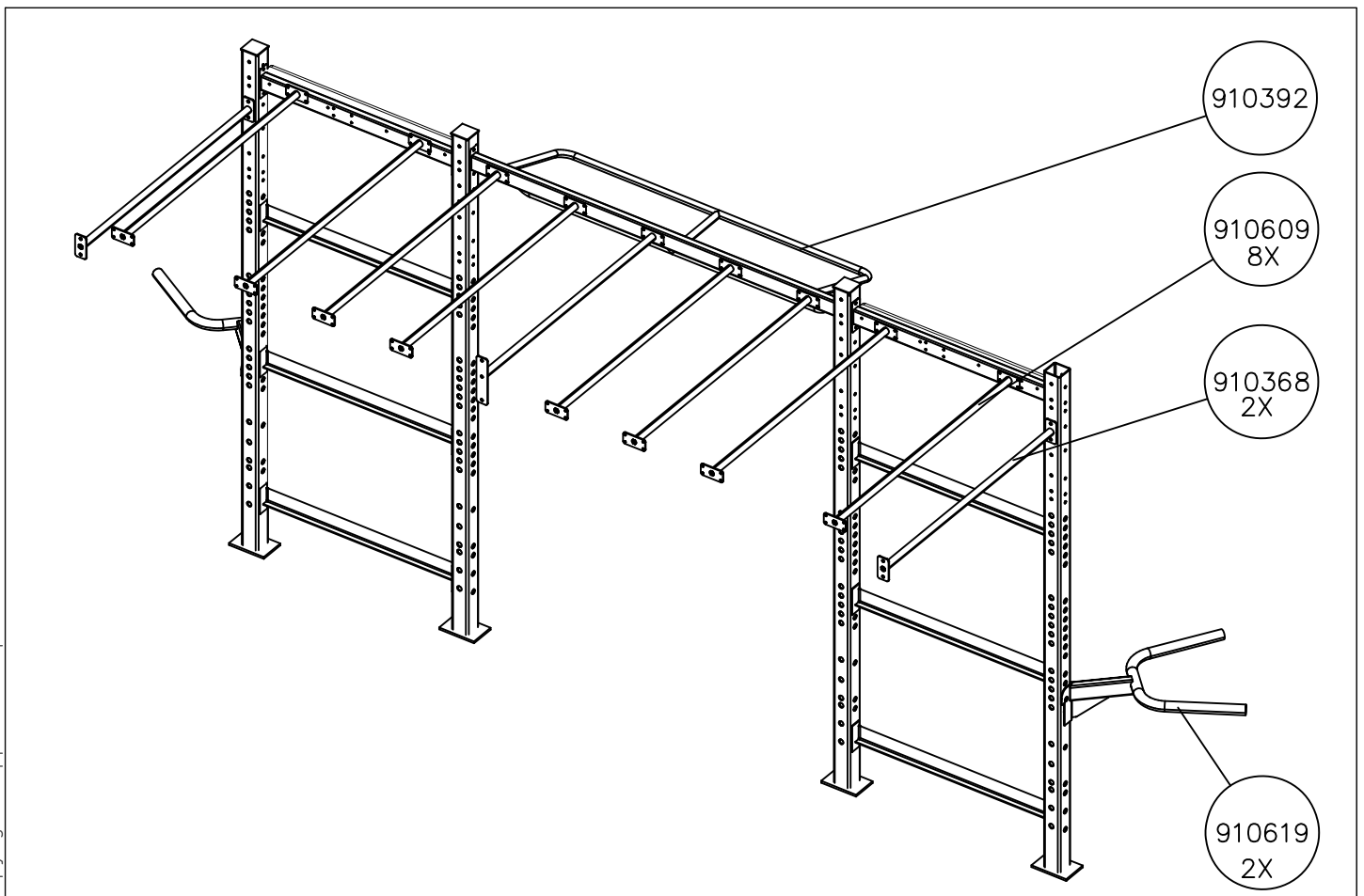
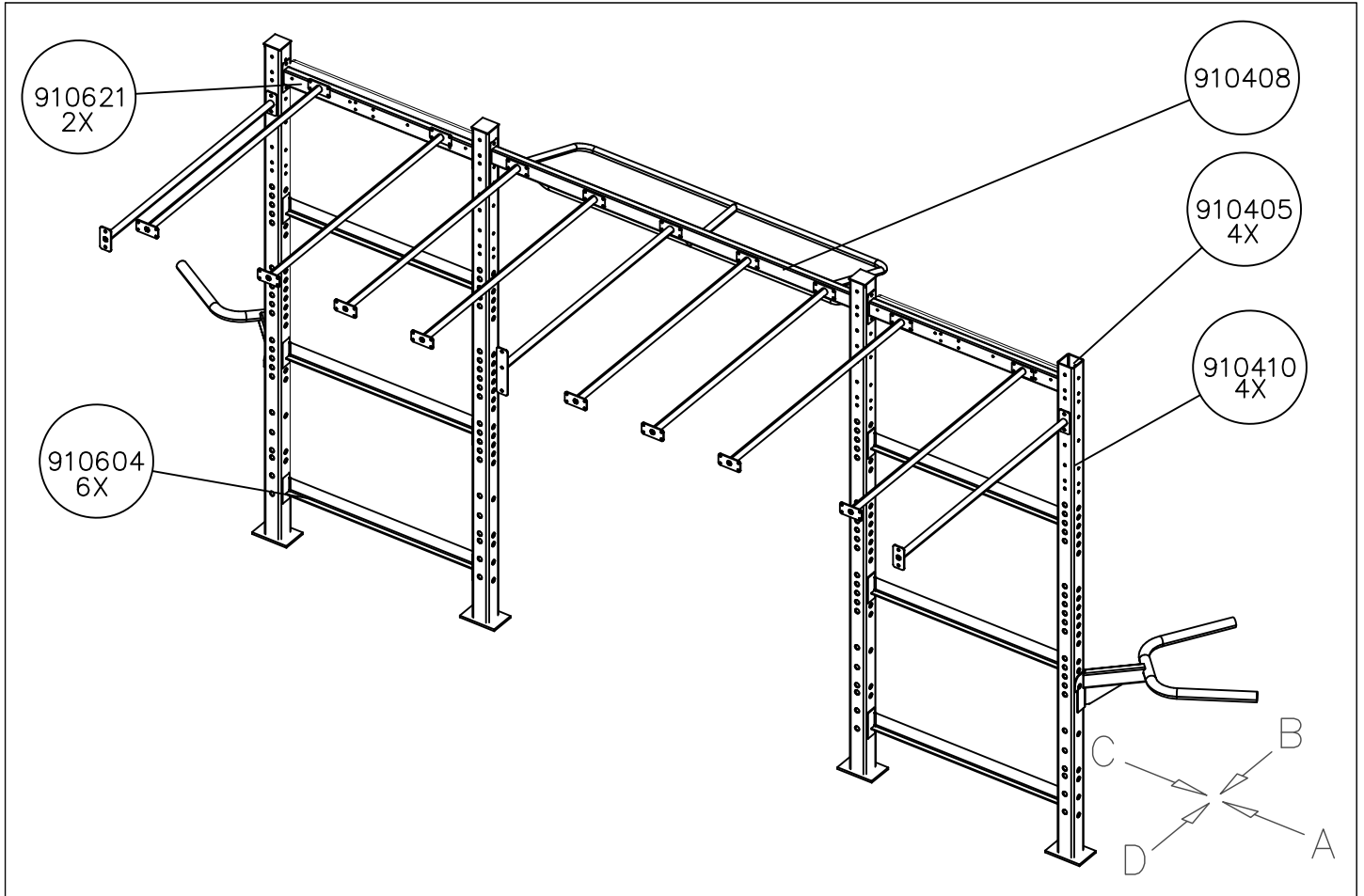

DATE: 4.1.2021

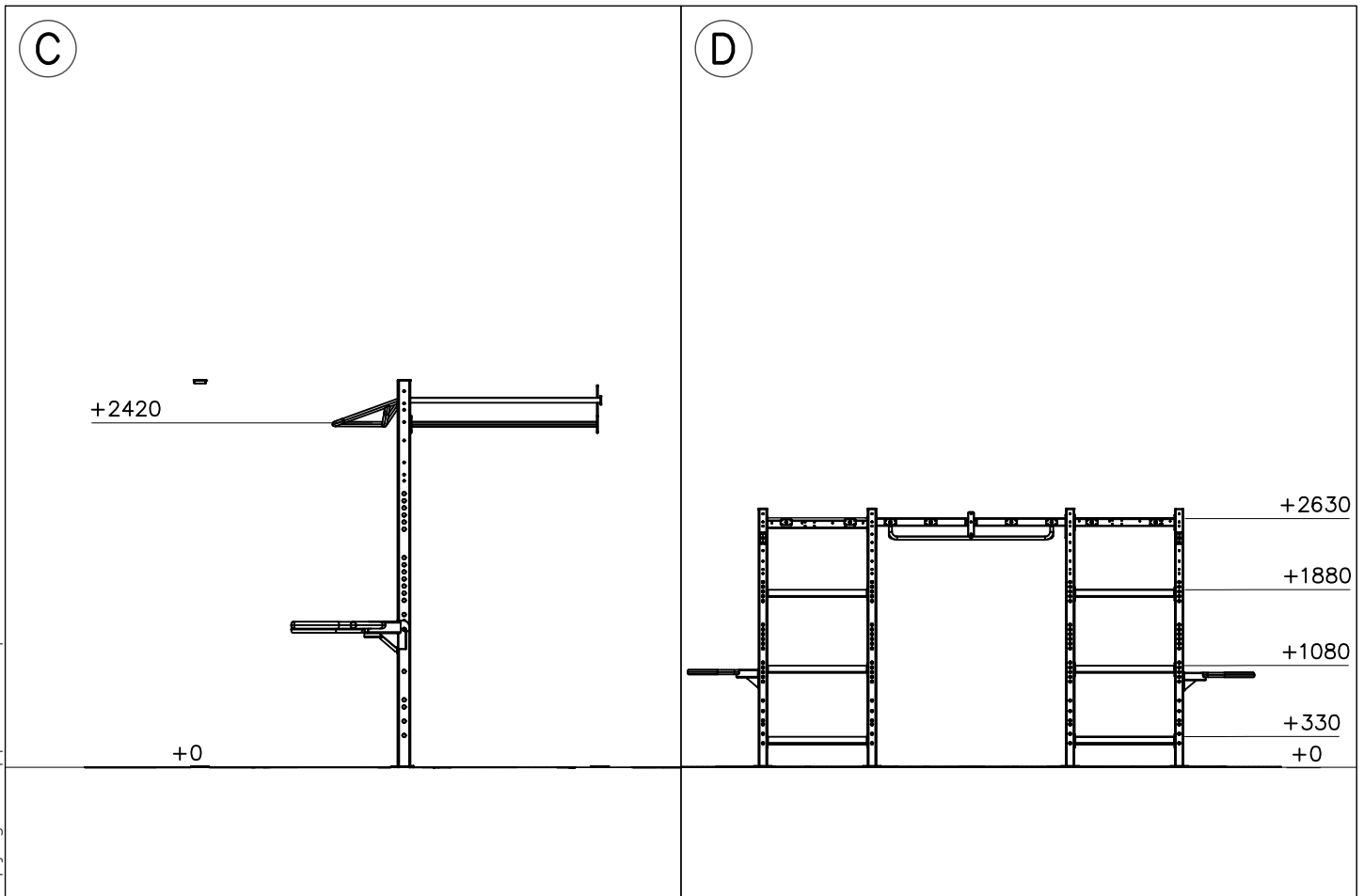
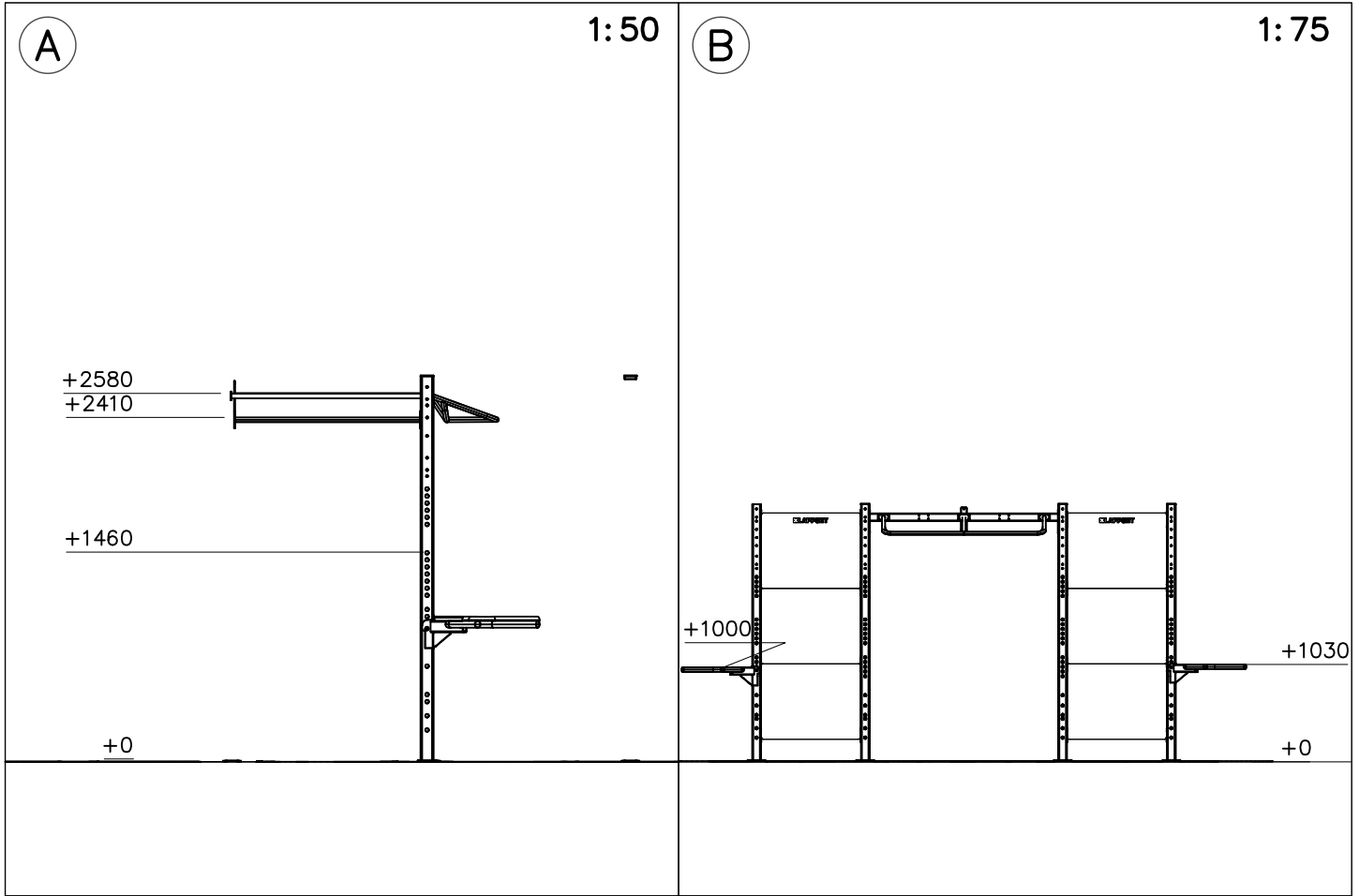

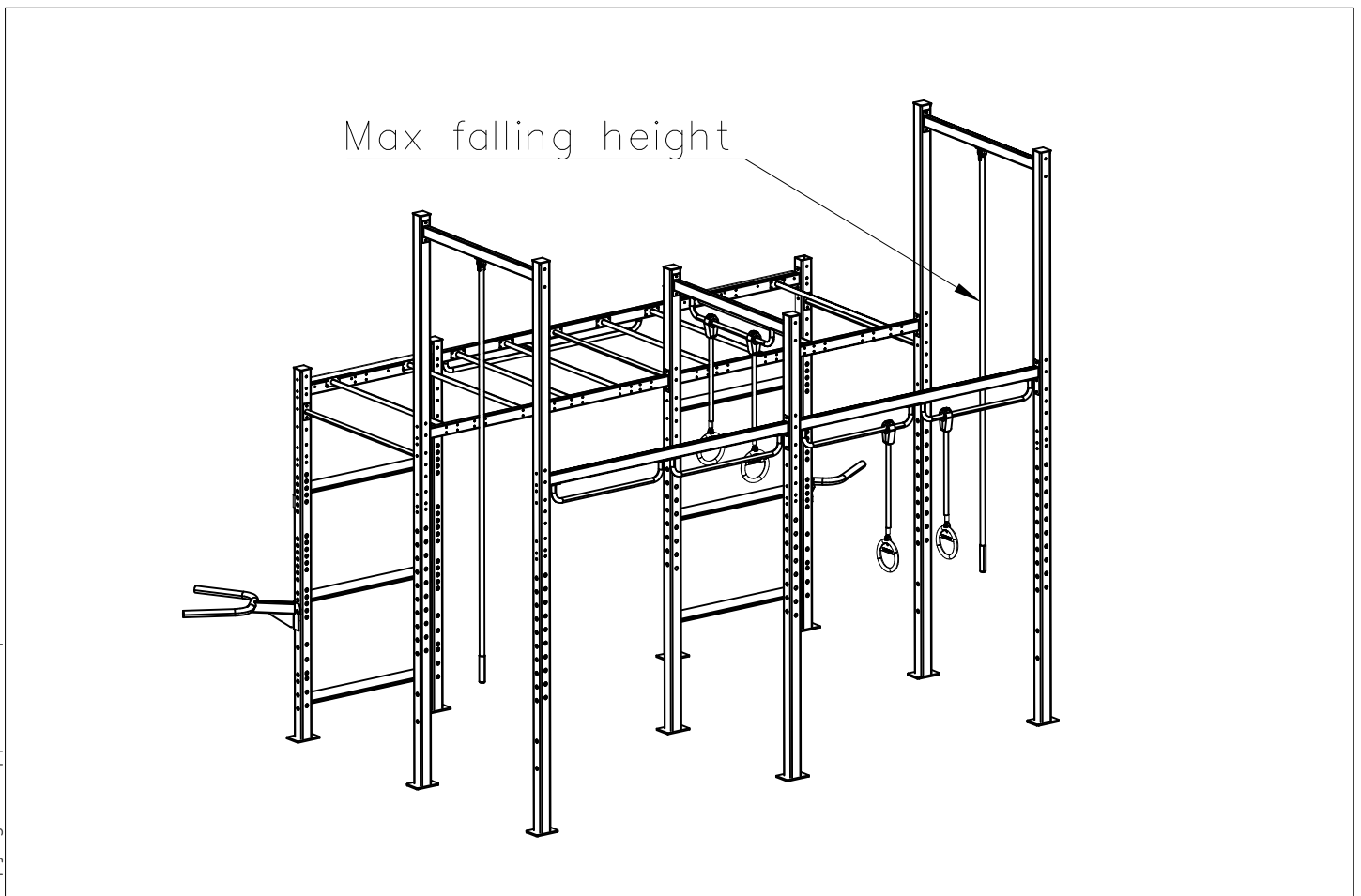
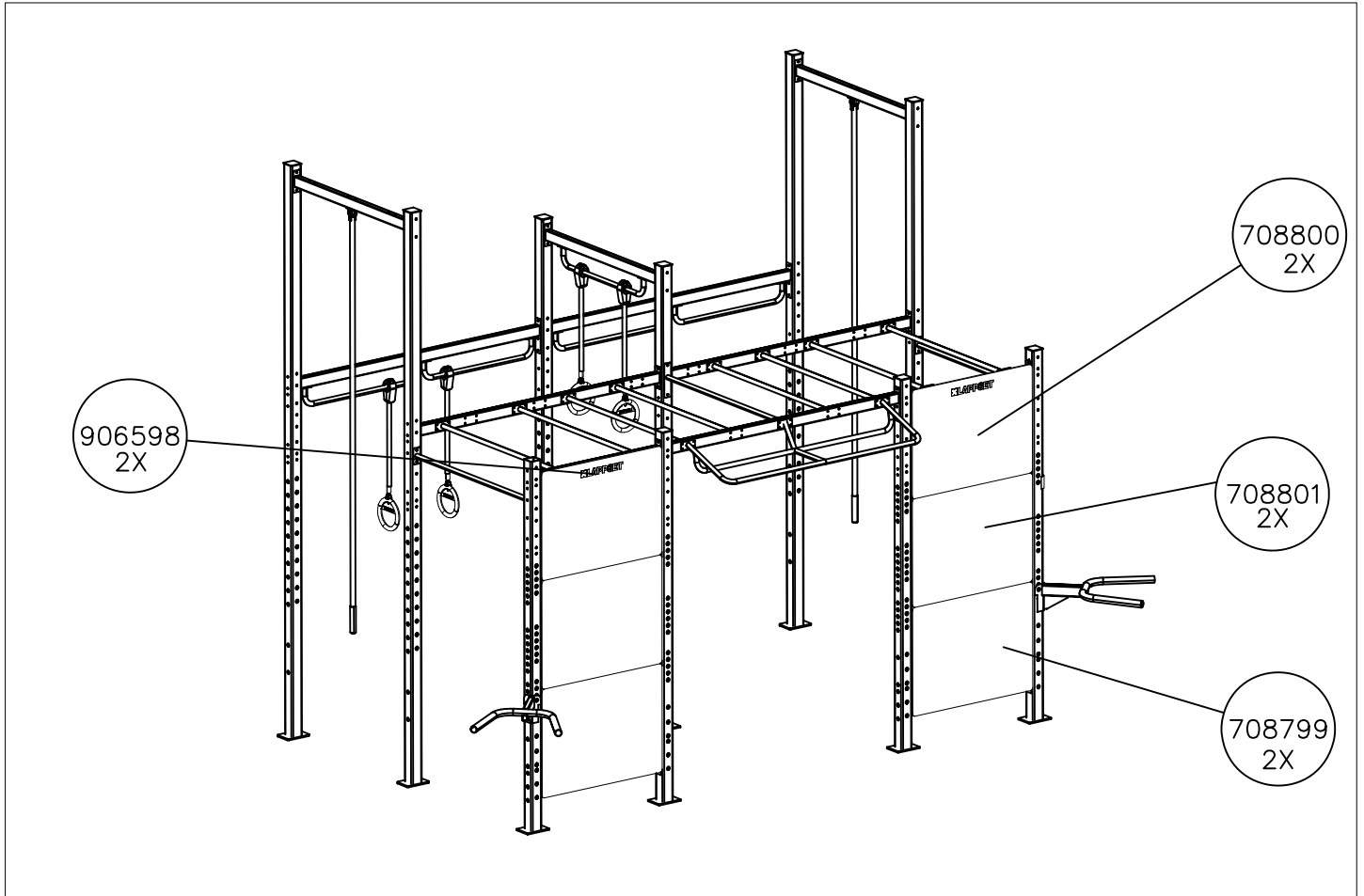

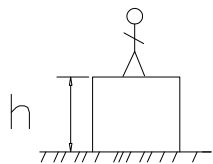

$h < 1000$

Totally hard surfaces or materials with very limited impact attenuating properties.

Totally hard surfaces.
E.g. concrete or asphalt



Case by case risk assessment is needed including e.g. evaluation whether there is forced movement, what is the intended exercise and where will the product be installed.

Materials with very limited impact attenuating properties.
E.g. wood



$h < 1200$

Materials with significant impact attenuating properties.

fine gravel 0–8 mm

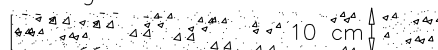

Unsorted sand/ topsoil

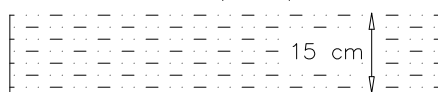

$h < 1500$

Lawn



$h < 3000$

Loose fill material

E.g.
sand/gravel 0,25...8 mm $D_{60}/D_{10} < 3,0$
Woodchips 5...30 mm
bark 20...80 mm

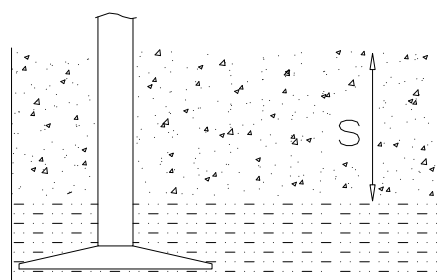

\underline{S}	\underline{h}
30 cm	$< 2,0$ m
40 cm	$< 3,0$ m

Syntetic granulates

\underline{S}	\underline{h}
40 mm	$\sim > 1,2...1,3$ m
50 mm	$\sim > 1,5...1,7$ m
60 mm	$\sim > 1,8...2,0$ m
70 mm	$\sim > 2,1...2,5$ m

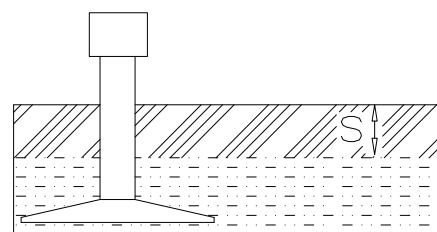

Note. For accurate values, see manufacturer's instructions.



Tuotekyltti tulee tuotteen mukana yhdellä seuraavista tavoista:

1) Metallinen tuotekyltti ja kiinnitysruuvit

- Kiinnitä tuotekyltti ruuveilla tolppaan noin 2 metrin korkeuteen kuvan 2 mukaisesti.

2) Tuotekyltitarra

- Puhdista maalattu metalli- tai vaneripinta pölystä ja kosteudesta. Liimaa tarra kuvan 3 mukaisesti.
- Huom. Älä kiinnitä tarraa karheapintaiseen laminaattiin tai maalattuun puuhun.

Vår produktmärkning levereras på ett av följande sätt:

1) Produktskylt i metall

- Fäst skylten med de medföljande skruvarna

2) Självhäftande produktetikett

- Rengördenpulverlackerademetallytanellerlaminatytansåttndenblirfrifrånsmutsochfukt.Fästetikettenenligtfig.3.
- Obs! Fäst ej etiketten på detaljer med skrovlig yta eller på målat trä.

Product label is delivered by one of following ways:

1) Metal product label and screws

- Fasten the label with screws.

2) Label sticker

- Cleanthepaintedmetalorplywoodsurfacefromdirtandmoisture.Fastenthestickerasshowninthefigure3.
- Note. Do not attach the sticker to rough surfaced laminate or painted wood.

La plaque d'informations produit est livrée sous l'une de ces 3 formes :

1) Plaque métallique et vis

- Fixez la plaque à l'aide des vis.

2) Etiquette autocollante

- Avant de coller l'étiquette, nettoyez le composant métallique peint ou la plaque de contreplaqué, de toute saleté. La surface doit être sèche (voir image 3).
- Attention, ne pas coller l'étiquette sur une surface lamellé-collée irrégulière ou sur du bois peint.

Die Auslieferung des Produktaufklebers erfolgt auf eine dieser Arten:

1) Produkt-Schild aus Metall incl. Schrauben

- Die Befestigung des Schildes erfolgt mittels der Schrauben.

2) Aufkleber

- EntfernenSiezunächstSchmutzundFeuchtigkeitvomlackiertenMetallbzw.vonderHolzoberflächeundbringenSiedenAufkleber wie im Bild oben rechts beschrieben auf den gesäuberten Untergrund auf.
- Beachten Sie: Bringen Sie den Aufkleber nicht auf raues laminiertes oder lackiertes Holz an.