

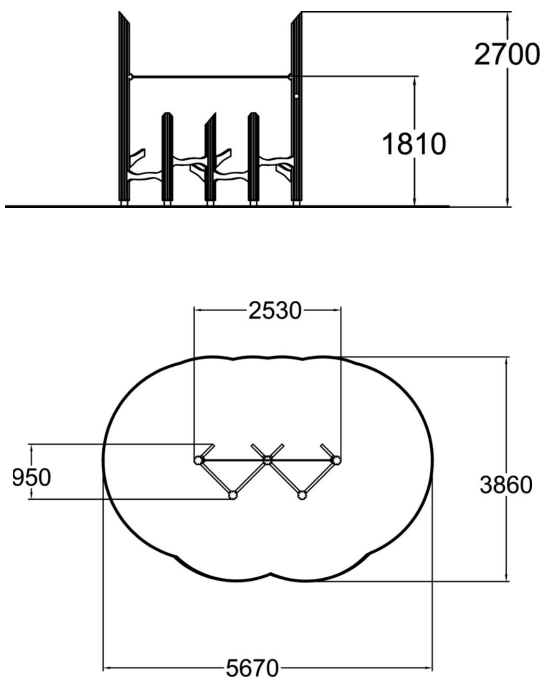

The Unicorn stall is an equipment that improves balance, agility and spatial perception, with max fall height of 60 cm. Without specific entry or exit points it is good for social interaction and communication, as well as for hanging out with friends. The Unicorn stall is a zig-zag shaped, 2,5 metre long balancing track with two higher and three lower posts which are connected by horizontal beams at two different heights. A rope connects the high posts at 1,7 meters. There are also four branches on three posts at two different levels.



User age	5+
Number of users	8
Product length, mm	2530
Product width, mm	950
Product height, mm	2700
Impact area, m ²	18
Falling space, m ²	18
Height required, mm	2700
Max. free fall height, mm	600
Safety info	EN 1176-1:2008
Installation time (for 1), H	4
Wood	