

DET 1

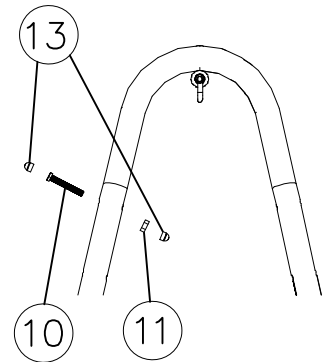

DET 2

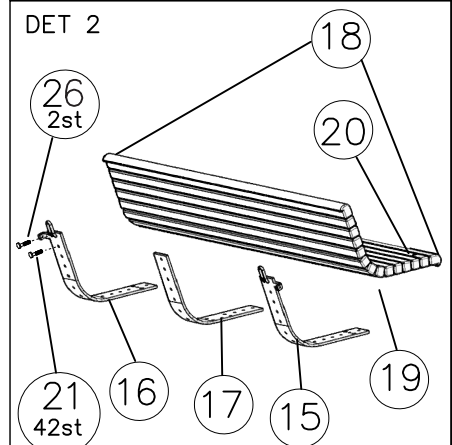

DET 3

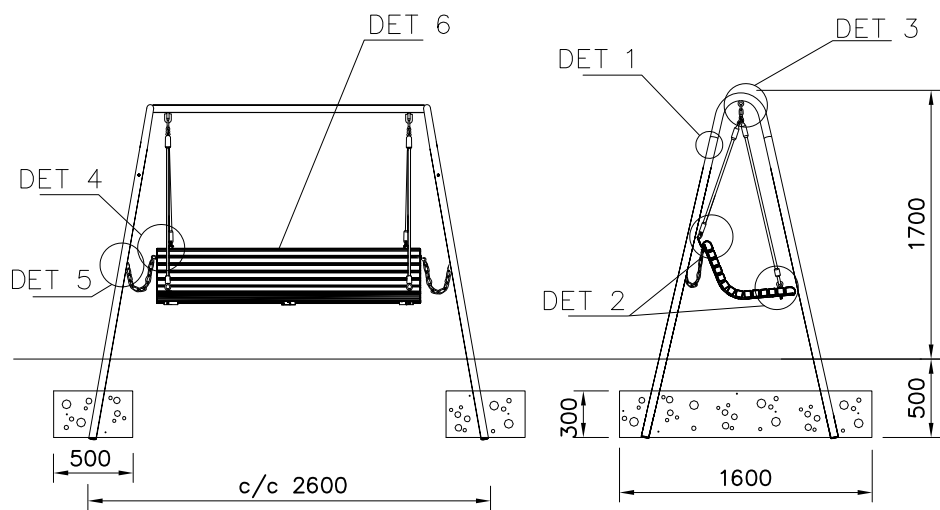
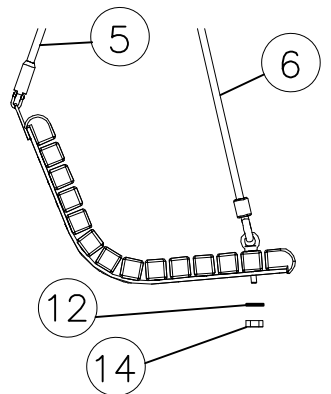

DET 4

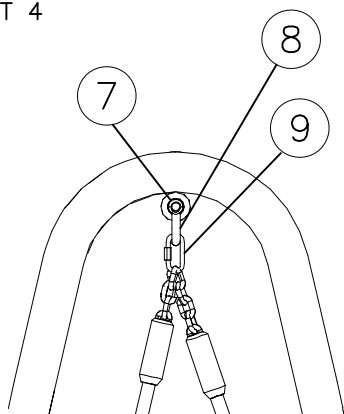



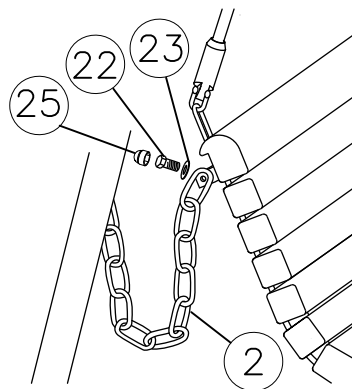



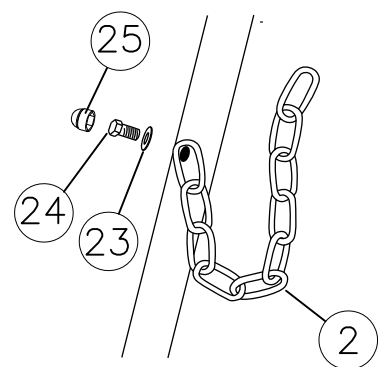

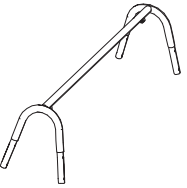





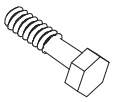

DET 5

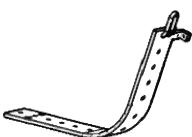
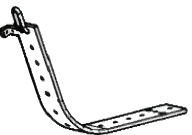
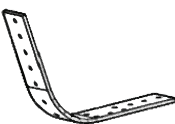
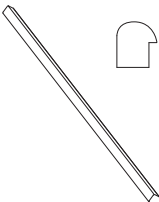
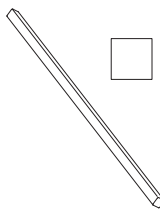
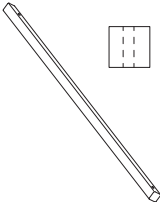
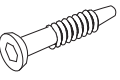

DET 6

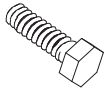

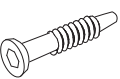
| | | | | |
|--|--|---|---|---|
| <p>① N902589</p>  <p>PCS/ST 1</p> | <p>② N00176</p>  <p>PCS/ST 2</p> | <p>③ N213123</p>  <p>PCS/ST 2</p> | <p>④ N213124</p>  <p>PCS/ST 2</p> | <p>⑤ 702440</p>  <p>L=675</p> <p>PCS/ST 2</p> |
| <p>⑥ 702441</p>  <p>L=970</p> <p>PCS/ST 2</p> | <p>⑦ 902599</p>  <p>PCS/ST 2</p> | <p>⑧ N00156</p>  <p>M10</p> <p>PCS/ST 2</p> | <p>⑨ N00155</p>  <p>M6</p> <p>PCS/ST 2</p> | <p>⑩ 902593</p>  <p>M10X60</p> <p>PCS/ST 8</p> |
| <p>⑪ 909637</p>  <p>M10</p> <p>PCS/ST 8</p> | <p>⑫ 980154</p>  <p>13X24X2.5</p> <p>PCS/ST 2</p> | <p>⑬ 905104</p>  <p>M10</p> <p>PCS/ST 16</p> | <p>⑭ 909248</p>  <p>M12</p> <p>PCS/ST 2</p> | <p>⑮ N213121</p>  <p>PCS/ST 1</p> |
| <p>⑯ N213122</p>  <p>PCS/ST 1</p> | <p>⑰ N902700</p>  <p>PCS/ST 1</p> | <p>⑱ N702411</p>  <p>PCS/ST 2</p> | <p>⑲ N702410</p>  <p>PCS/ST 11</p> | <p>⑳ N702412</p>  <p>PCS/ST 1</p> |
| <p>㉑ N00109</p>  <p>7X30</p> <p>PCS/ST 42</p> | <p>㉒ N01920</p>  <p>M8X20</p> <p>PCS/ST 2</p> | <p>㉓ N13818</p>  <p>18X9X1.5</p> <p>PCS/ST 4</p> | <p>㉔ N01930</p>  <p>M8X30</p> <p>PCS/ST 2</p> | <p>㉕ 902607</p>  <p>M8</p> <p>PCS/ST 4</p> |
| <p>㉖ N00189</p>  <p>7X35</p> <p>PCS/ST 2</p> | | | | |