

LB270G

Revision: 1.1
Date: Marts 3, 2021

Billie

Assembly instructions
Montageanleitung • Montagevejledning



264cm

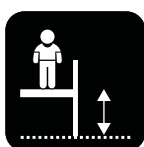

90/140/190 cm



4+



Ja/Yes



2



10H



405 x 226 x 272 cm



734 x 604 cm

Good advice and tips

Ein paar gute Ratschläge und Tipps • Gode råd og vejledning

GB

- Take all components from the pallet and place them on the ground
- Compare with components list – is everything there?
- Be at all times precise when measuring
- Unpack one component at a time and assemble it
- Usage of a water-level will increase precision
- Fall protection is the very last thing to be installed – along with the producer's label

D

- Alle Bauteile von der Palette nehmen und auf den Boden legen.
- Anhand der Bauteileliste überprüfen, ob alle Teile vorhanden sind
- Beim Abmessen generell präzise arbeiten
- Ein Bauteil nach dem anderen auspacken und montieren
- Die Benutzung einer Wasserwaage erleichtert die Montage
- Die Fallschutzunterlage wird erst ganz zum Schluss verlegt – dann, wenn das Produzentenetikett angebracht wird

DK

- Tag komponenterne af pallen og læg dem på jorden
- Check efter komponentlisten om alle er med
- Vær omhyggelig med afstande generelt
- Pak én komponent ud af gangen og gør denne færdig
- Vær omhyggelig med brug af vatterpas
- Faldunderlag etableres til allersidst sammen med påsætning af mærkning med producent

Clearance and safety surfaces

Platzbedarf und Fallschutzunterlage • Pladshensyn og faldunderlag

Safety surface in accordance with EN 1176

Fallschutzunterlag gemäß EN 1176

Faldunderlag i overensstemmelse med EN 1176

	Height • Höhe • Højde	(*) Area • Fläche • Areal
A	90 cm	2,13 m ²
B	140 cm	1,38 m ²
C	190 cm	0,84 m ²
D	202 cm	3,5 m ²
E	265 cm	23,46 m ²
Total		31,31 m ²

(*) Areas are accurately calculated values which are difficult to achieve in practice.
Die Flächen haben die genaue berechneten Werte, aber sind schwer in Praxis zu erreichen.
Arealerne er nøjagtigt beregnede værdier, som er vanskelige at opnå i praksis.

(**) Slide exit areas are equivalent to a height of 100 cm.
Der Auslaufs Bereich der Rutsche, ist äquivalent eine Höhe von 100 cm.
Rutsjebaneudløbsområder svarer til en højde på 100 cm.

Scale • Maßstab • Målstok 1:100

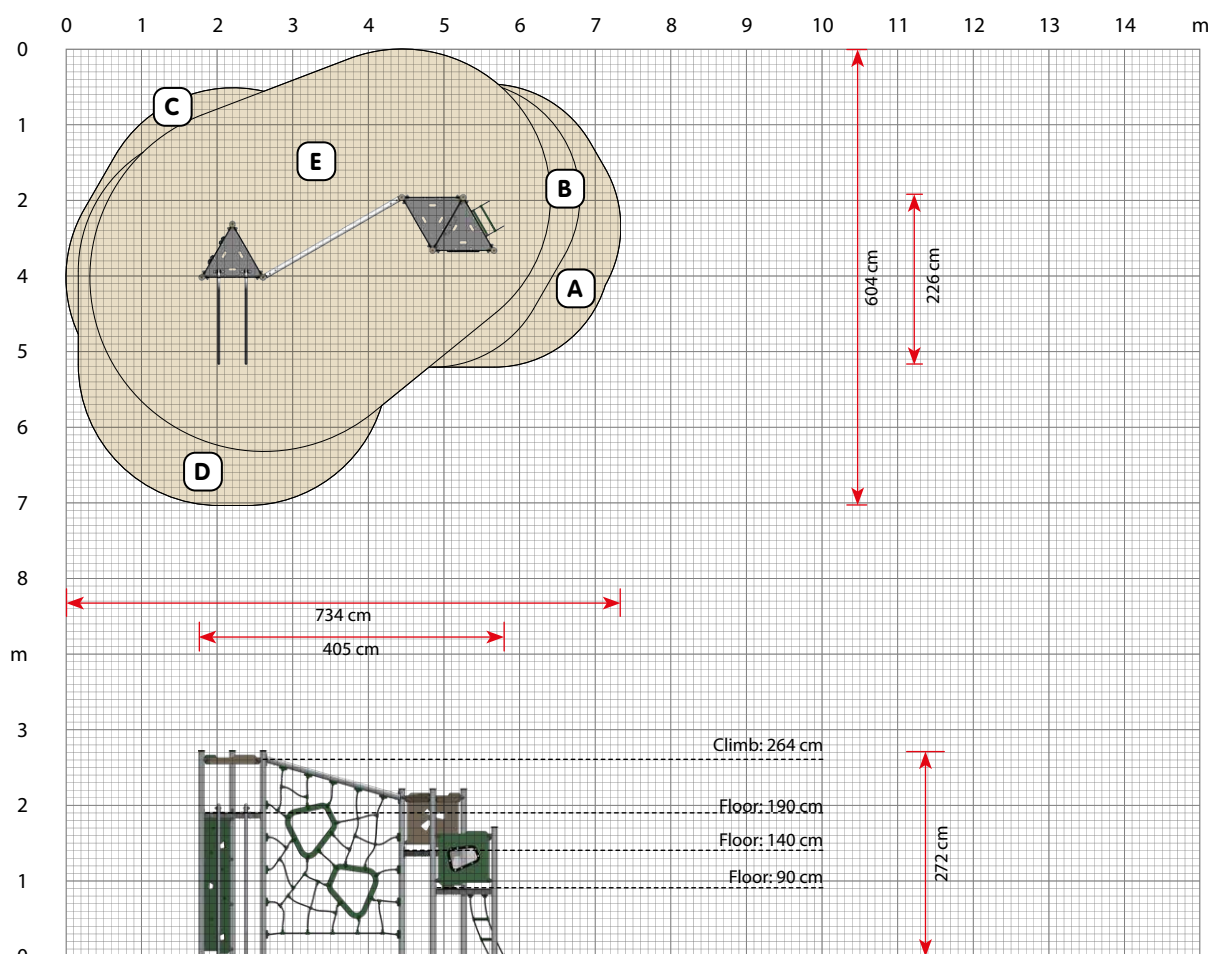

Components overview

Bauteileübersicht • Komponentensicht

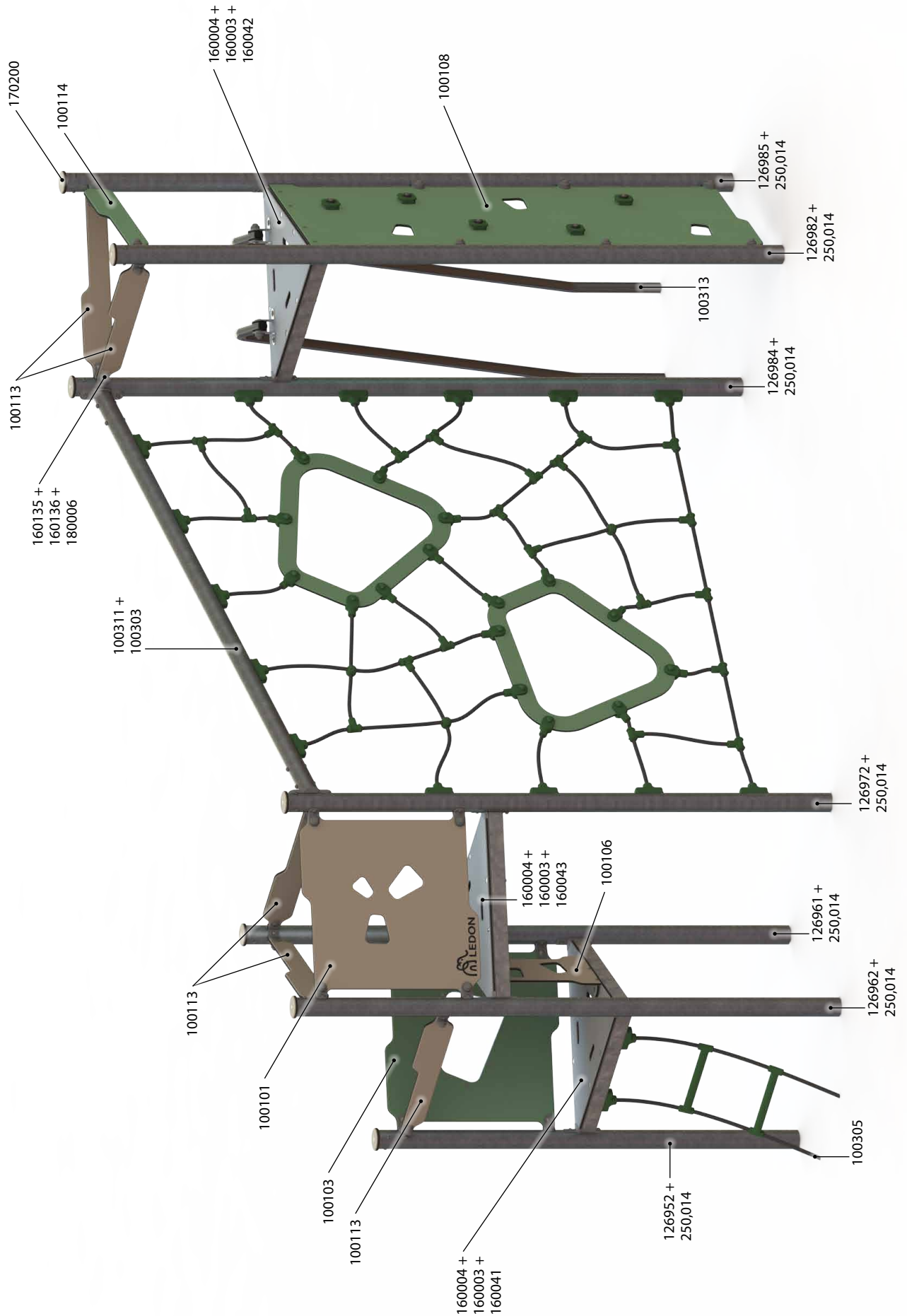

Site preparation

Vorbereitung • Pladsforberedelse

Digging depths • Grabtyper • Gravedybder:

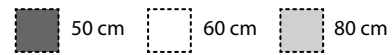

All holes with no other specified dimensions are $\varnothing 25$ cm.

Alle Bohrungen ohne anderen angegebenen Abmessungen sind $\varnothing 25$ cm.

Alle huller uden anden angivet dimension er $\varnothing 25$ cm.

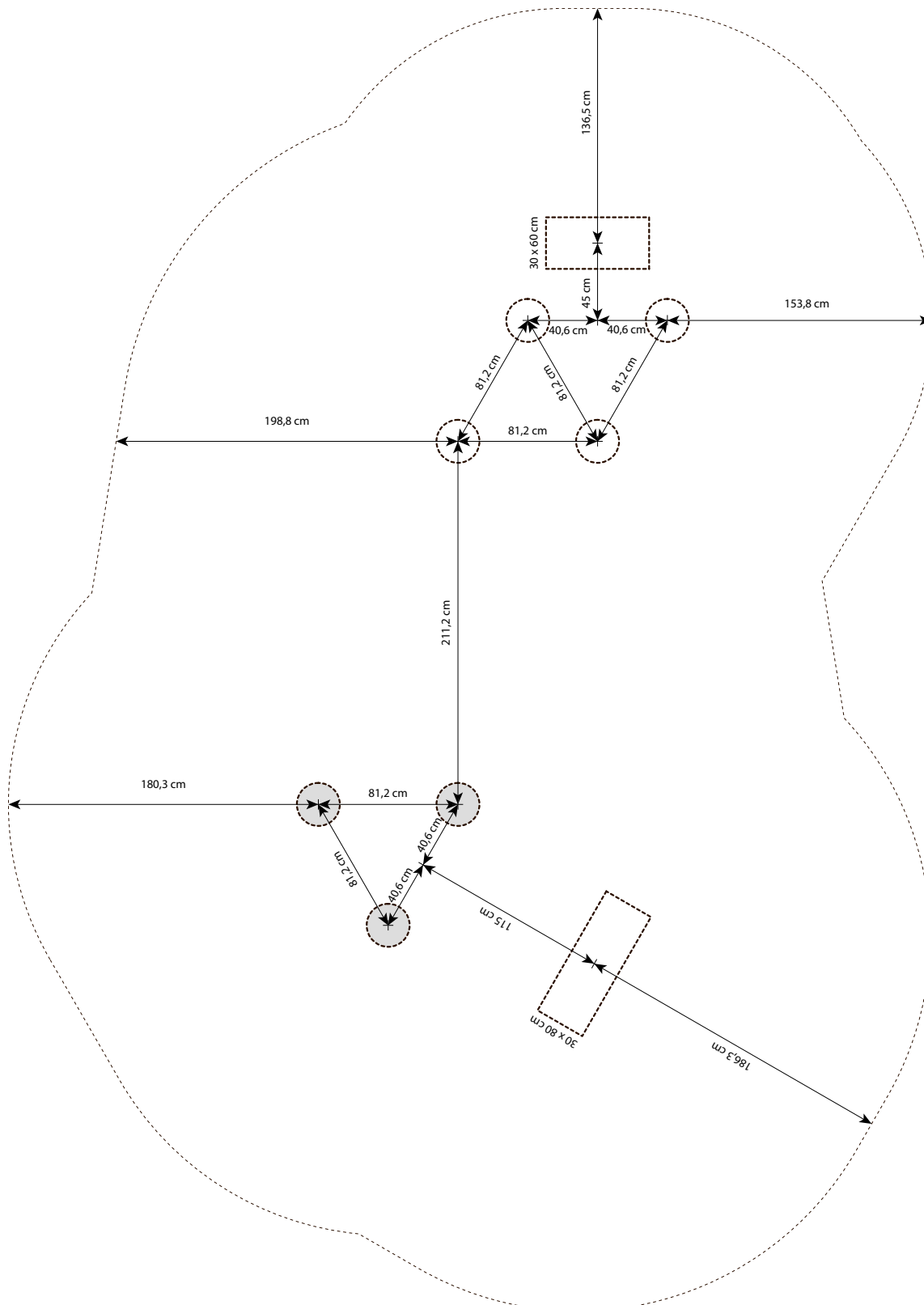

Assembly

Montage • Montage

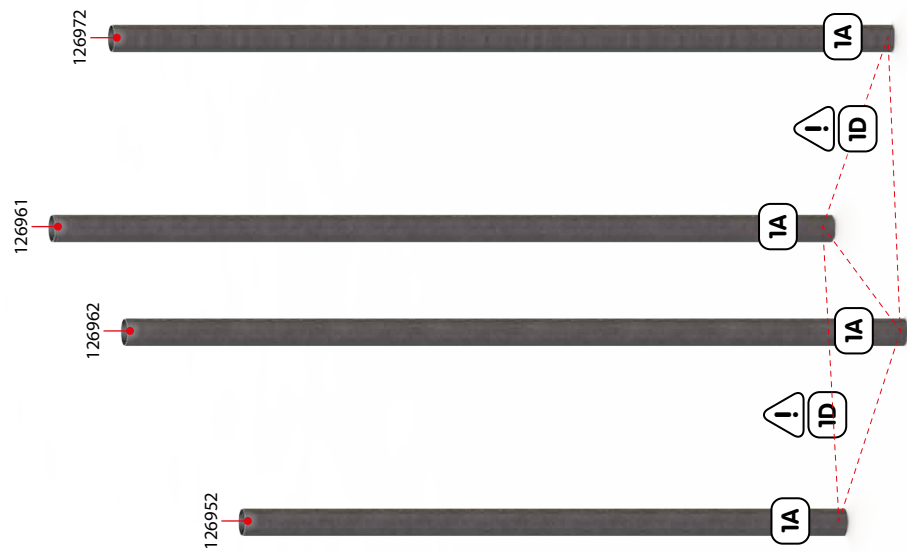
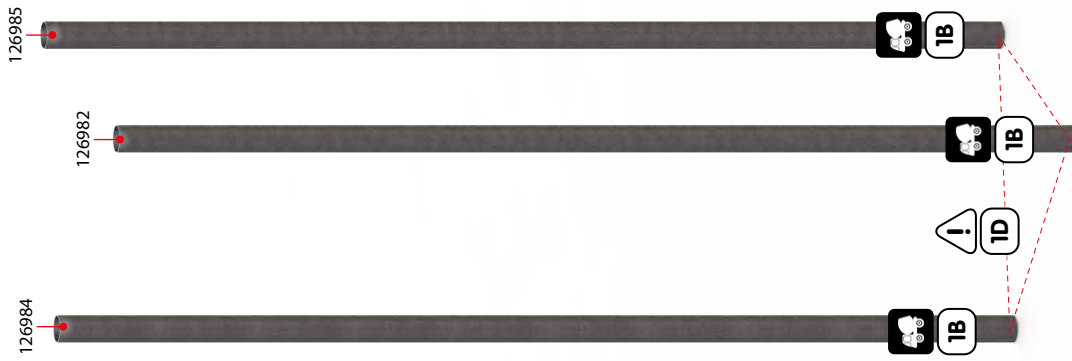

Assembly

Montage • Montage

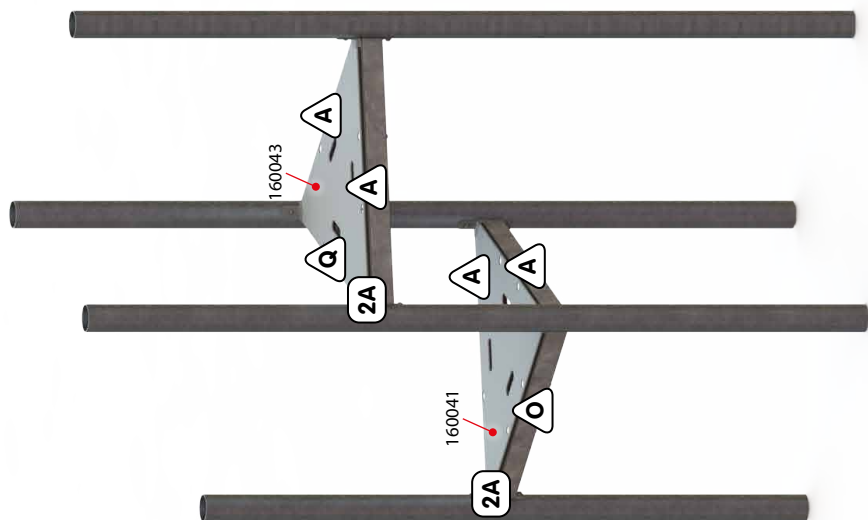
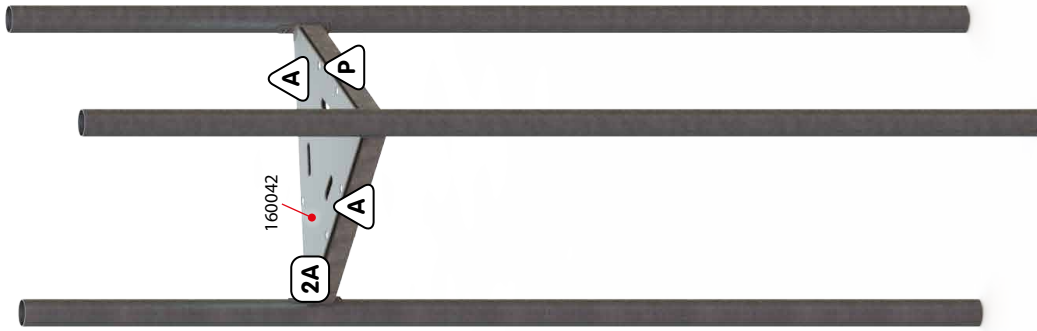

Assembly

Montage • Montage

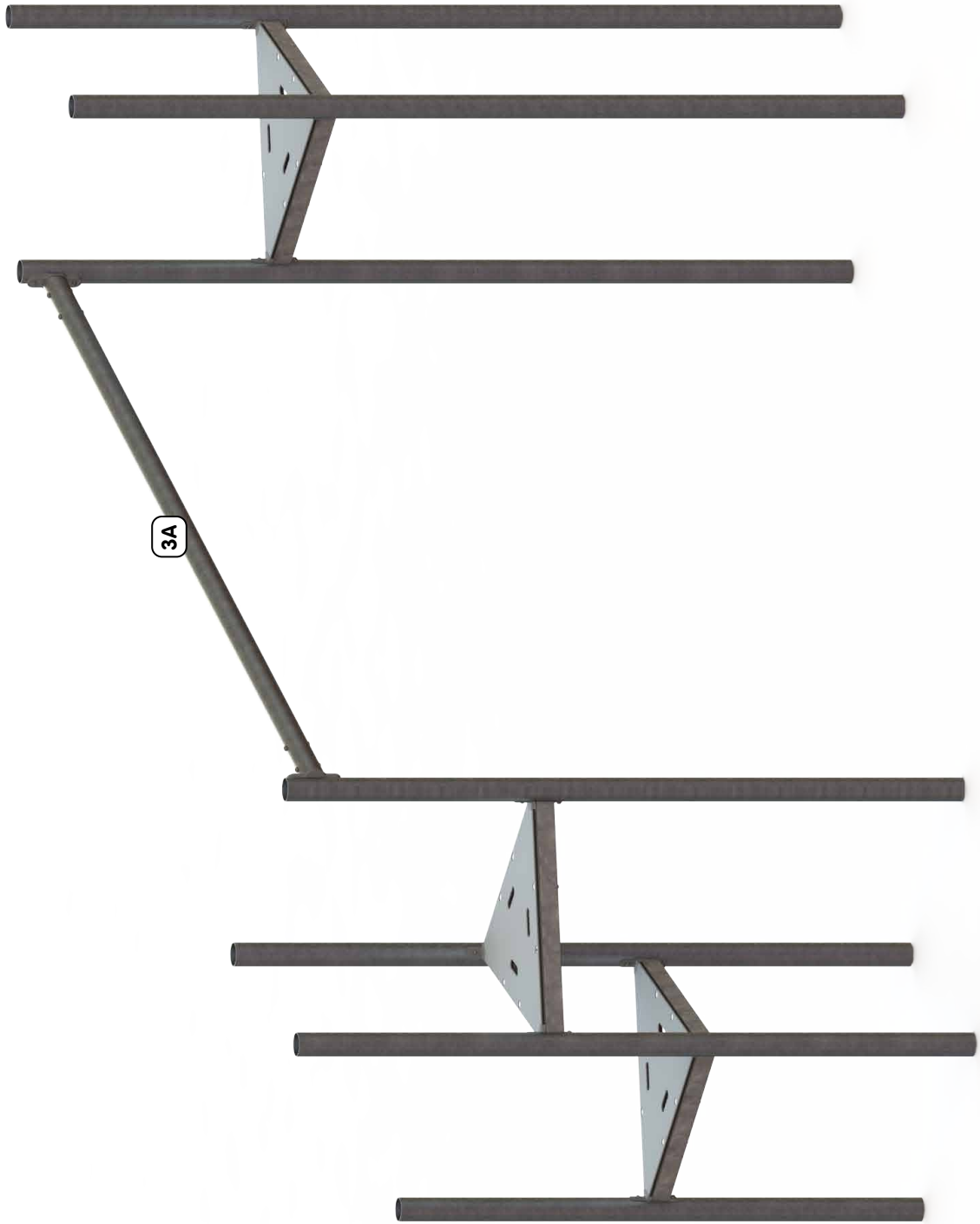

Assembly

Montage • Montage

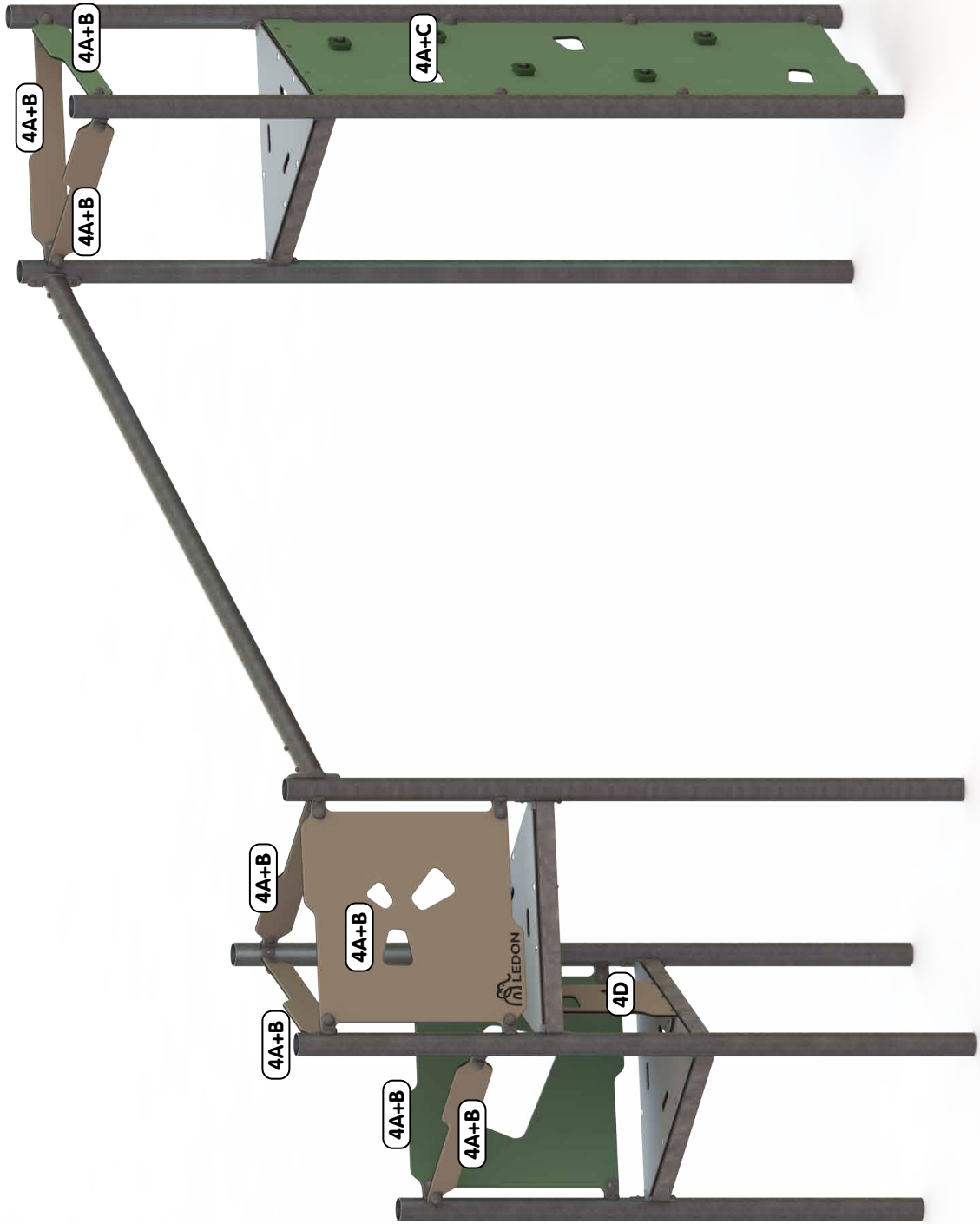

Assembly

Montage • Montage

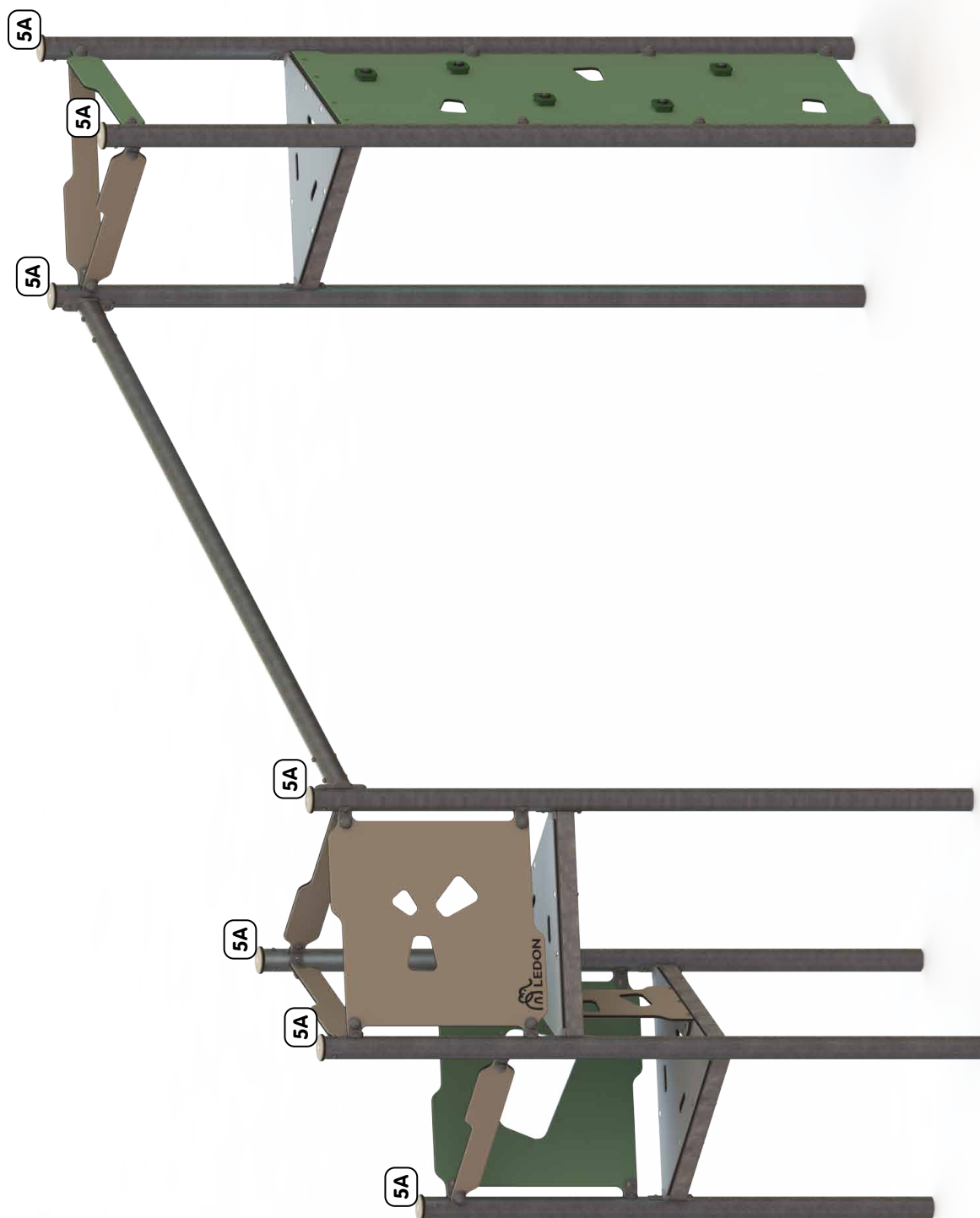

Assembly

Montage • Montage



Assembly

Montage • Montage

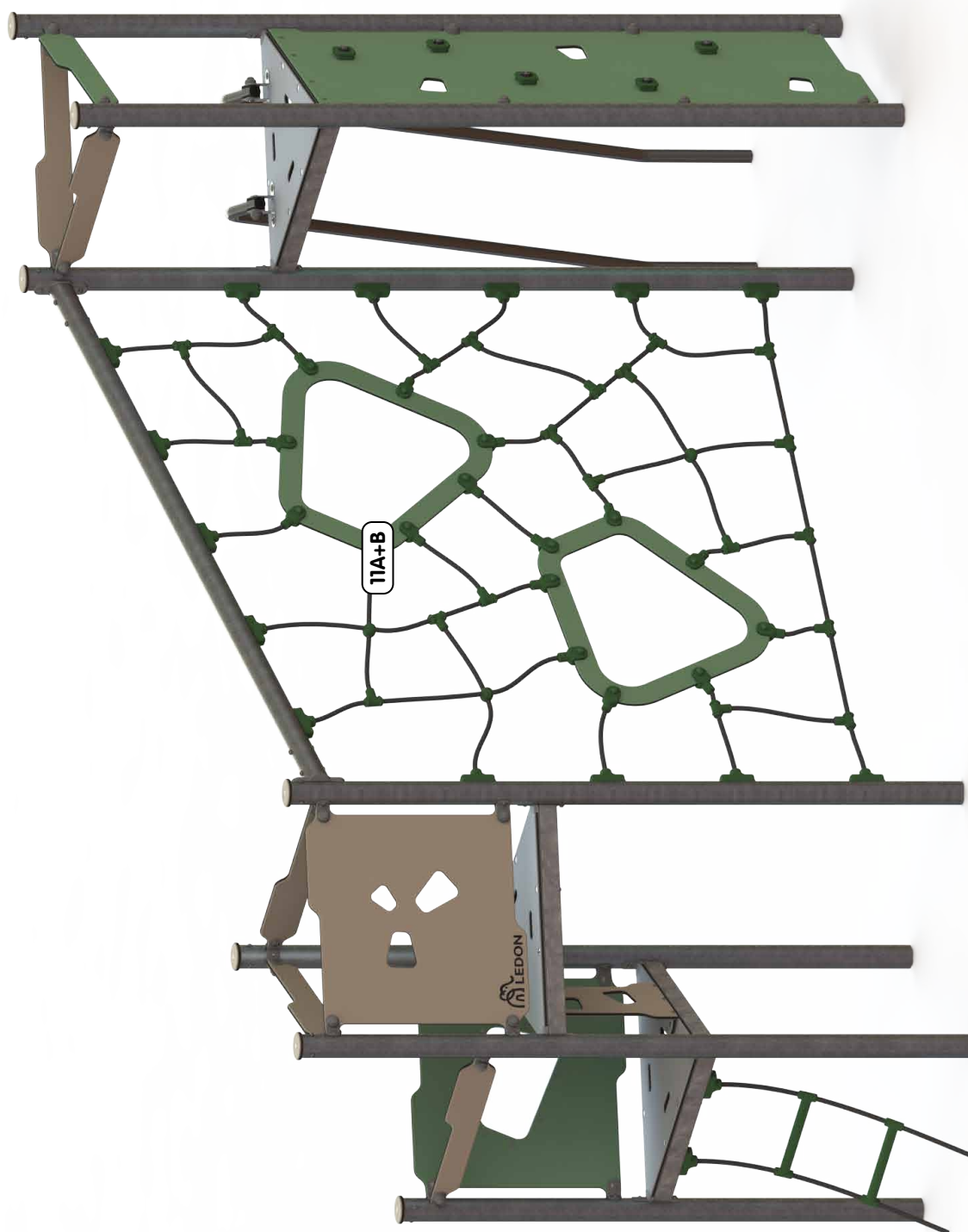

Assembly

Montage • Montage

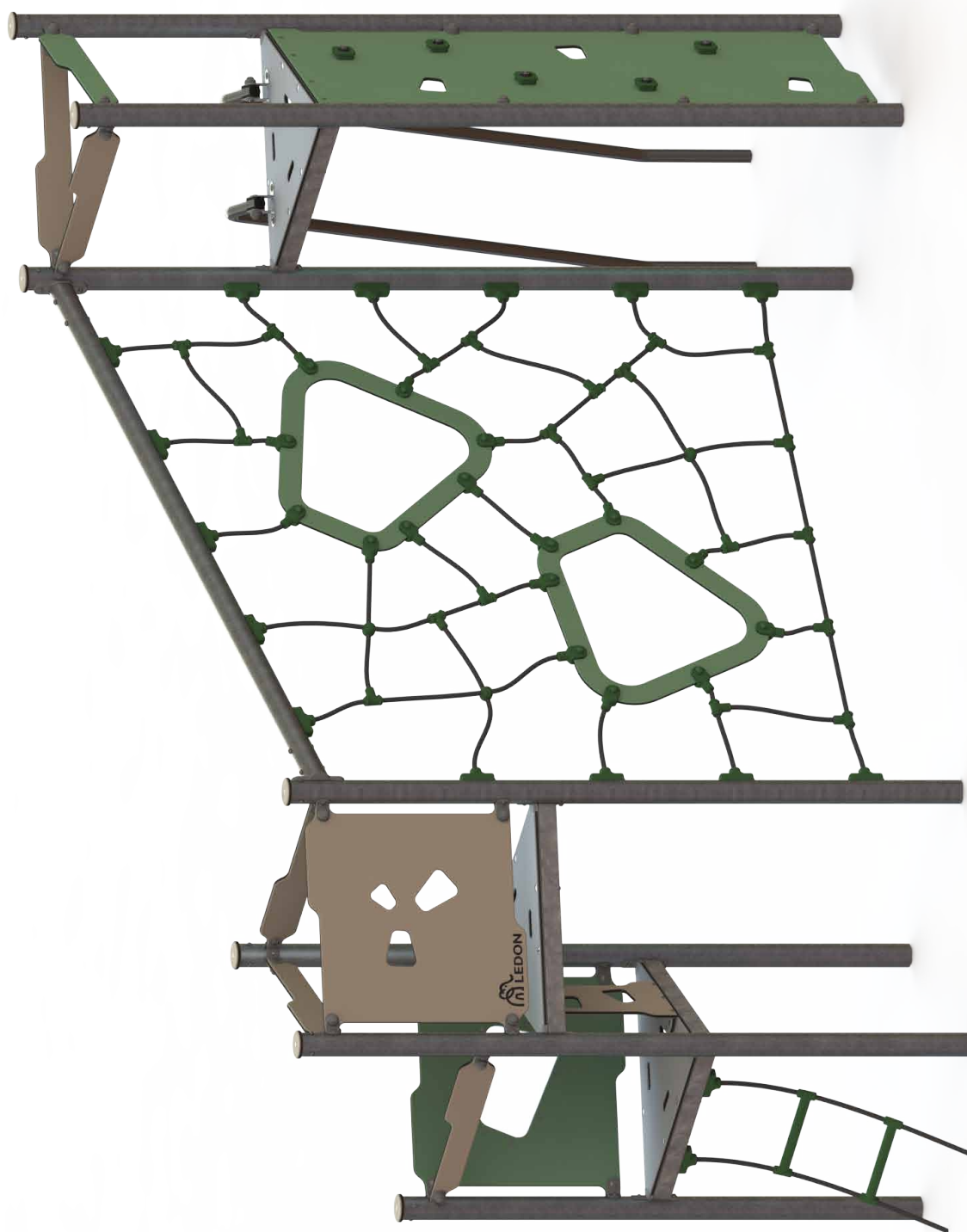

Ready
Færdig • Færdig