

Contents

Tips and hints	3
Tube slide assembly example	4
Tunnel Maker assembly instructions	5
Start panel	6
Useful information about LEDON tubes	7
Assembling the first tube	10
Tube assembly – general	11
Window tube assembly	12
Tube assembly – finishing	13
Exit chute	14
Exit chute – installation of anchoring	17
Exit chute – installation of concrete bracket	19
Assembly of exit chute with/without exit chute extension	20
Trenching of ground anchor	21
Installation of exit chute to concrete	23
Finished tube slide	24
Assembly of exit chute extension	25
General installation of exit chute and extension	26
Installing the exit chute extension	28
Positioning – exit chute and exit chute extension	29
Ground anchoring of exit chute + exit chute extension	30
Trenching of ground anchor	31
Adjusting and trenching the ground anchor	33
Concrete anchoring of exit chute + exit chute extension	34
Exit chute extension – anchoring to concrete	35
Installation of support posts for tube slide	36

Tips and hints

1. Remove the components from the pallet and place them on the ground
2. Check the accompanying list of components to ensure that all the components have been supplied
3. Unwrap one component at a time, and assemble it completely before taking another component
4. Be precise when using the spirit level
5. Safety surfacing is laid once the tube slide is fully installed and labelled by the manufacturer

Tips:

Slides with a start height **below 2 metres** can be assembled on the ground and then raised into position.

Slides with a start height **above 2 metres** should be assembled on the ground before being raised into position.

We have tried to make our assembly instructions as comprehensive as possible.

However, if you have any advice or tips for us, please pass them on.

Please email info@ledon.dk or use the contact form on our website – www.ledonplay.com

Tube slide assembly example

Here, we will go through the assembly instructions, taking the beautiful, curved and colourful LEDON tube slide shown below as an example.

Each tube slide is unique, and must be assembled and installed according to the specific LEDON Tunnel Maker assembly instructions.

If a support post is necessary, please refer to the separate installation instructions on page 36.

It is important to ensure that there is no inherent tension in the tube slide after it has been fully assembled and installed.

Always remember to follow LEDON assembly and installation instructions.



Tunnel Maker assembly instructions

It is a good idea to refer to the LEDON Tunnel Maker assembly instructions when assembling/installing a tube slide. In the following example, we will show you how.

Example of Tunnel Maker assembly instructions:

Filename: Ledon tube slide start 366 cm Startheight: 366.0 cm
 Printed: 11/7/2014 at 10:27 Dimensions: 182 x 326 cm
 Version: Tunnel Maker v2r12

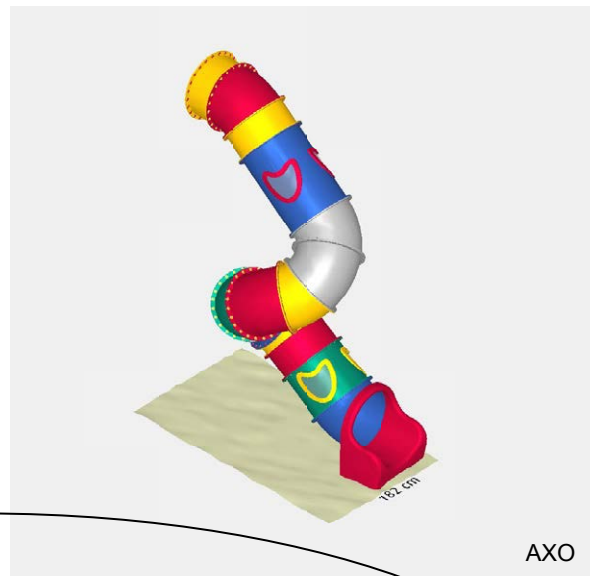
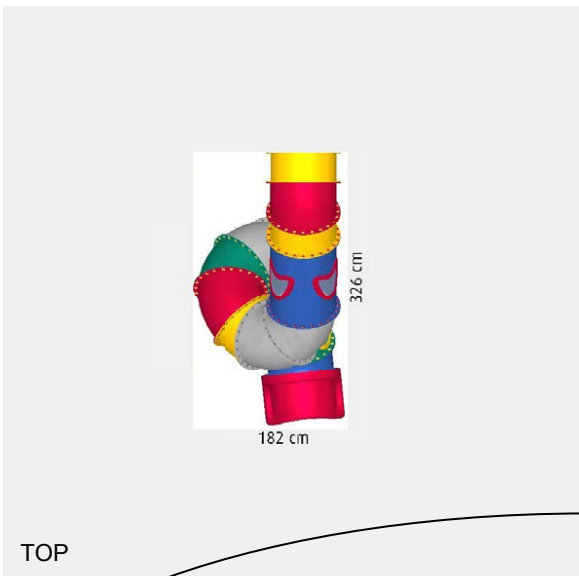

Mounting guide:

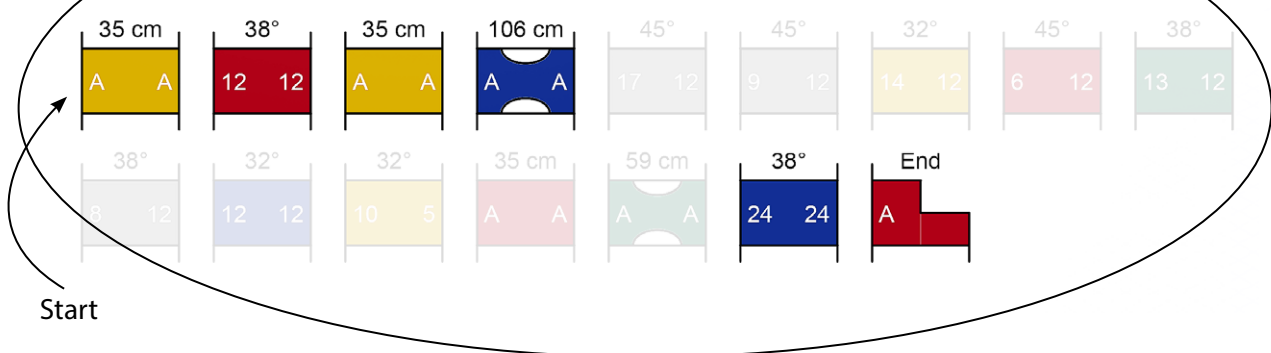

Start panel

To start:

Assembling a tube slide always starts with the start panel.

Attach the fibre and bolts as shown below.

Mounting guide:

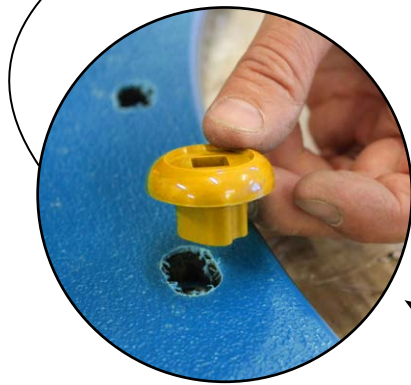
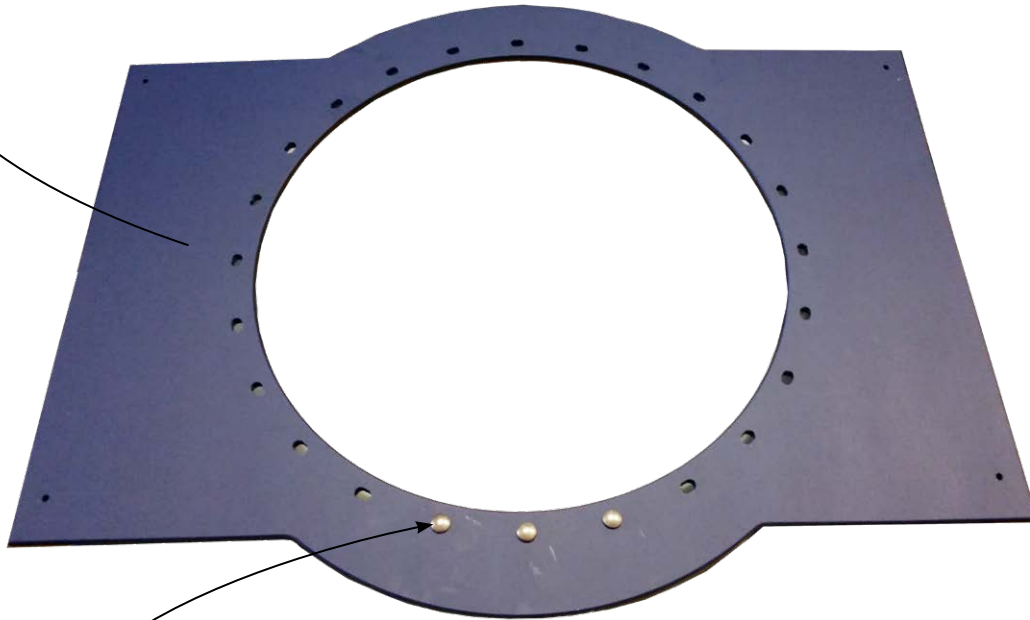
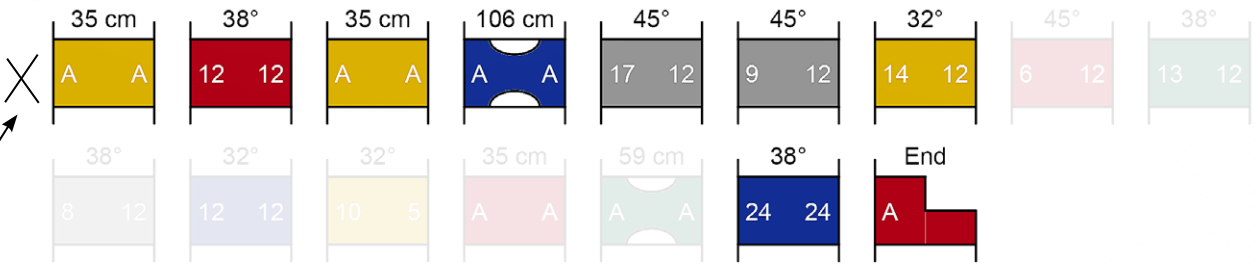

Useful information about LEDON tubes

Straight tubes: All straight tubes are marked with the letter 'A' at each end of the tube – please refer to the Tunnel Maker assembly and installation instructions supplied by LEDON. The tube should be positioned so that the 'A' is always sitting uppermost.

Example of assembly instructions:

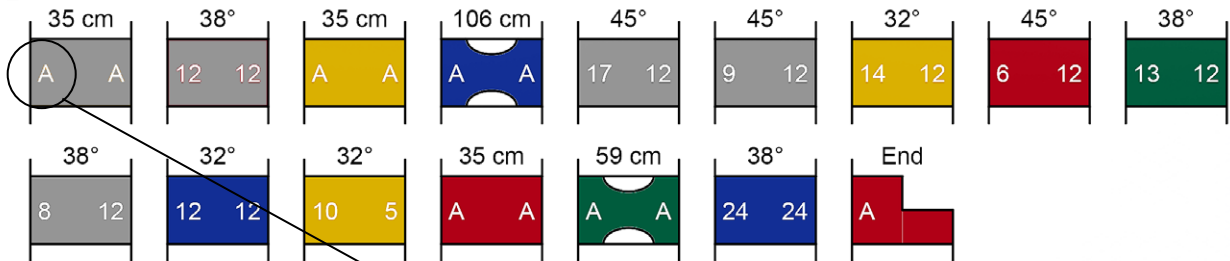

Useful information about LEDON tubes

Curved tubes: All curved tubes are numbered 1-24 next to each flange hole.

To see the position of the respective numbers, please refer to the Tunnel Maker assembly and installation instructions supplied by LEDON – see below.

Example of assembly instructions:

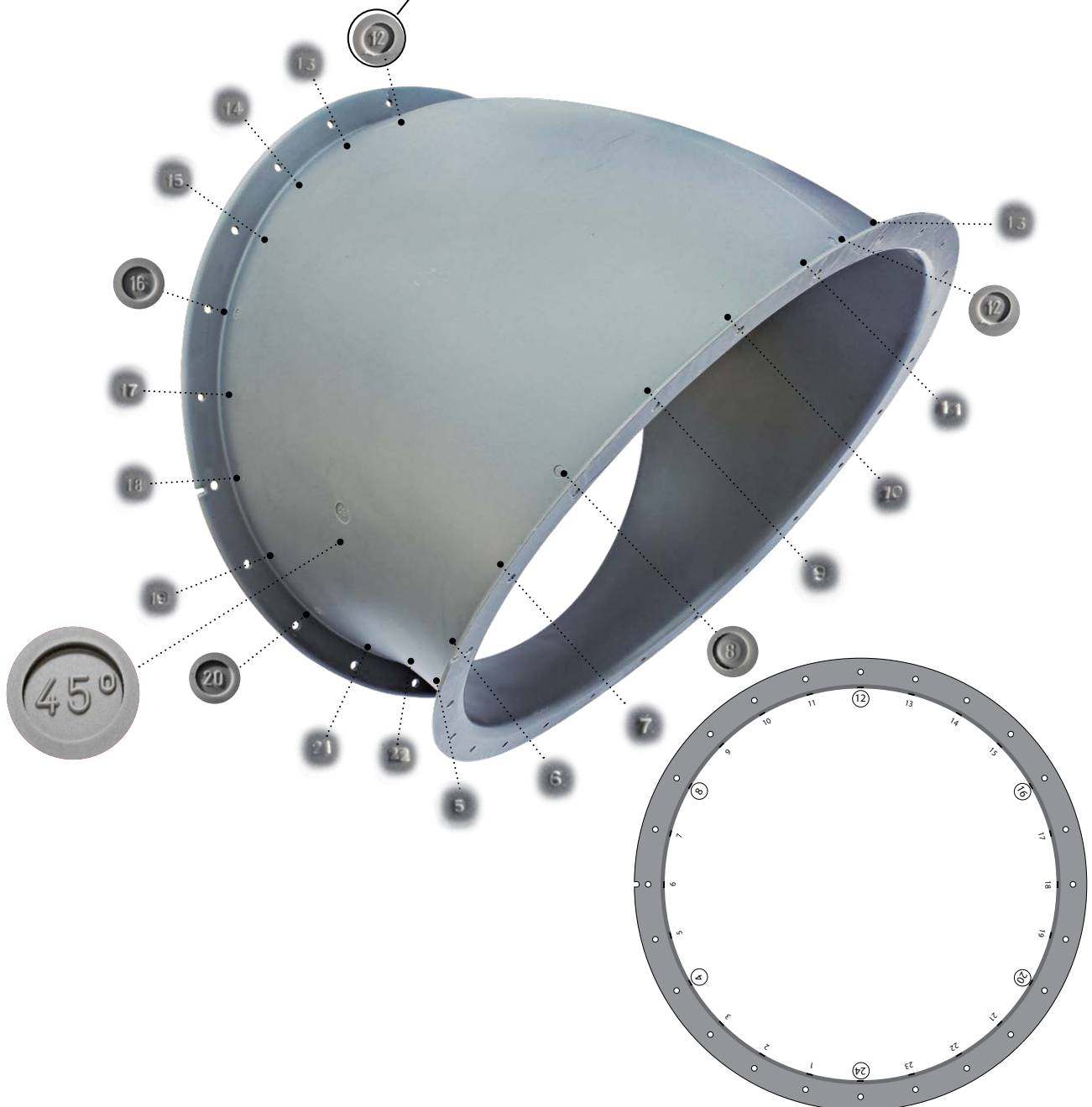
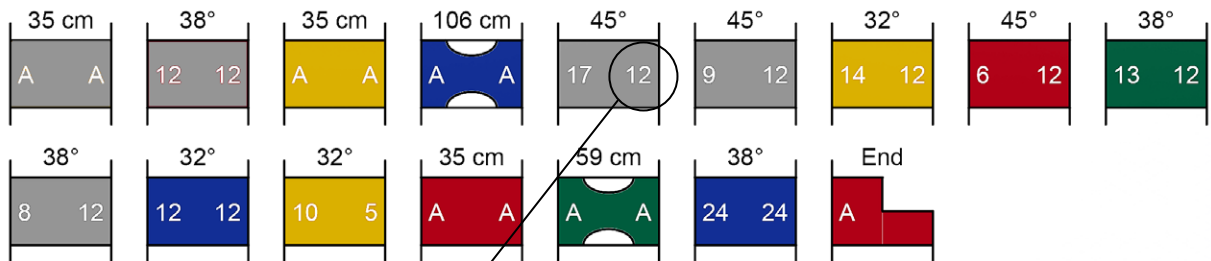

Useful information about LEDON tubes

Important: Be careful to ensure that the tube slide is not forced into a position that creates inappropriate tension in the joints between the tubes which may cause damage to the tube slide.

Example of incorrect tube slide installation:

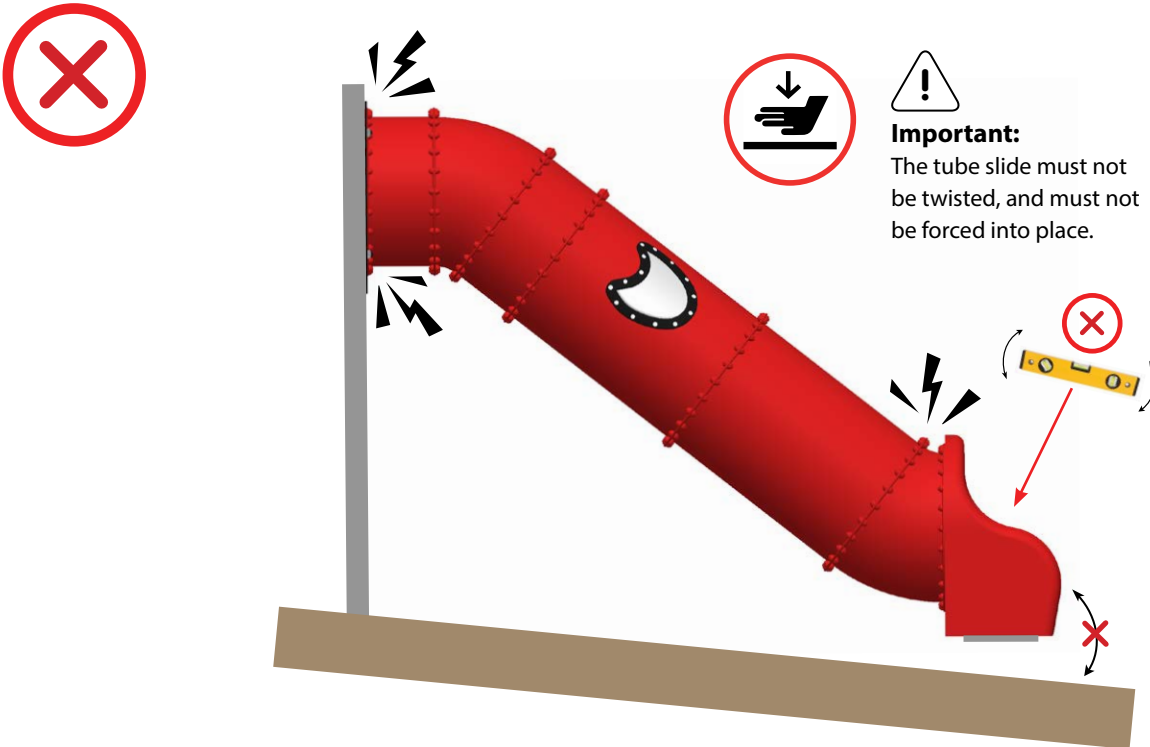

Example of correct tube slide installation:

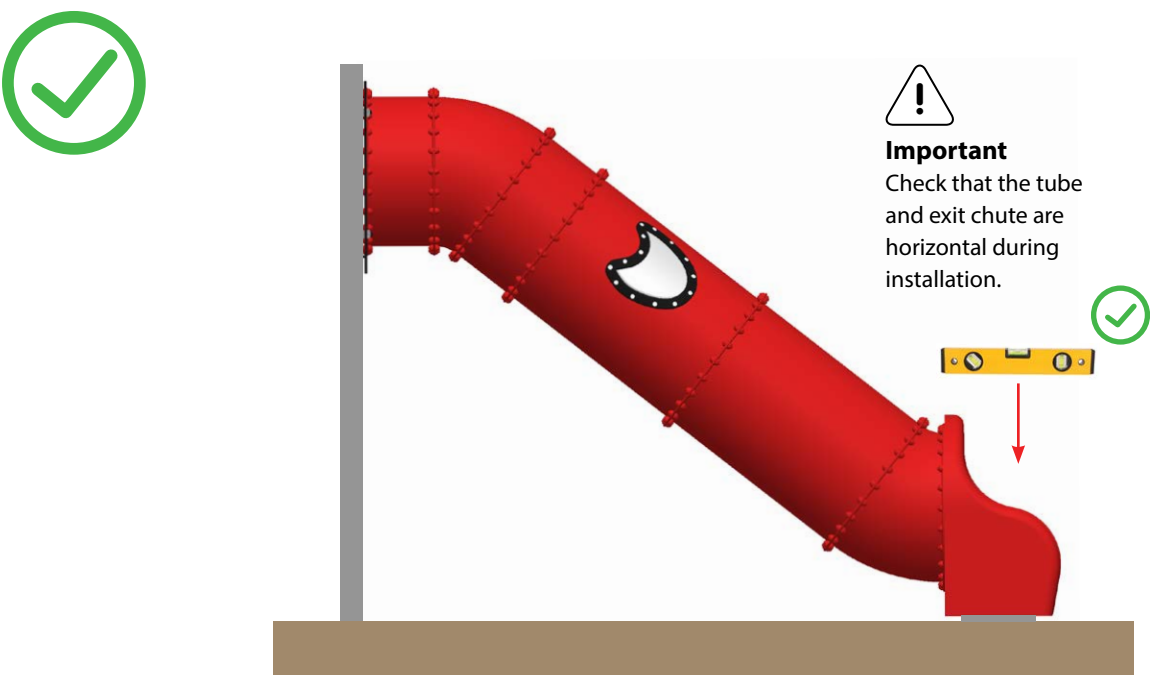

Assembling the first tube

Attach the first tube to the start panel so that the 'A' is sitting uppermost on the tube.

Mounting guide:

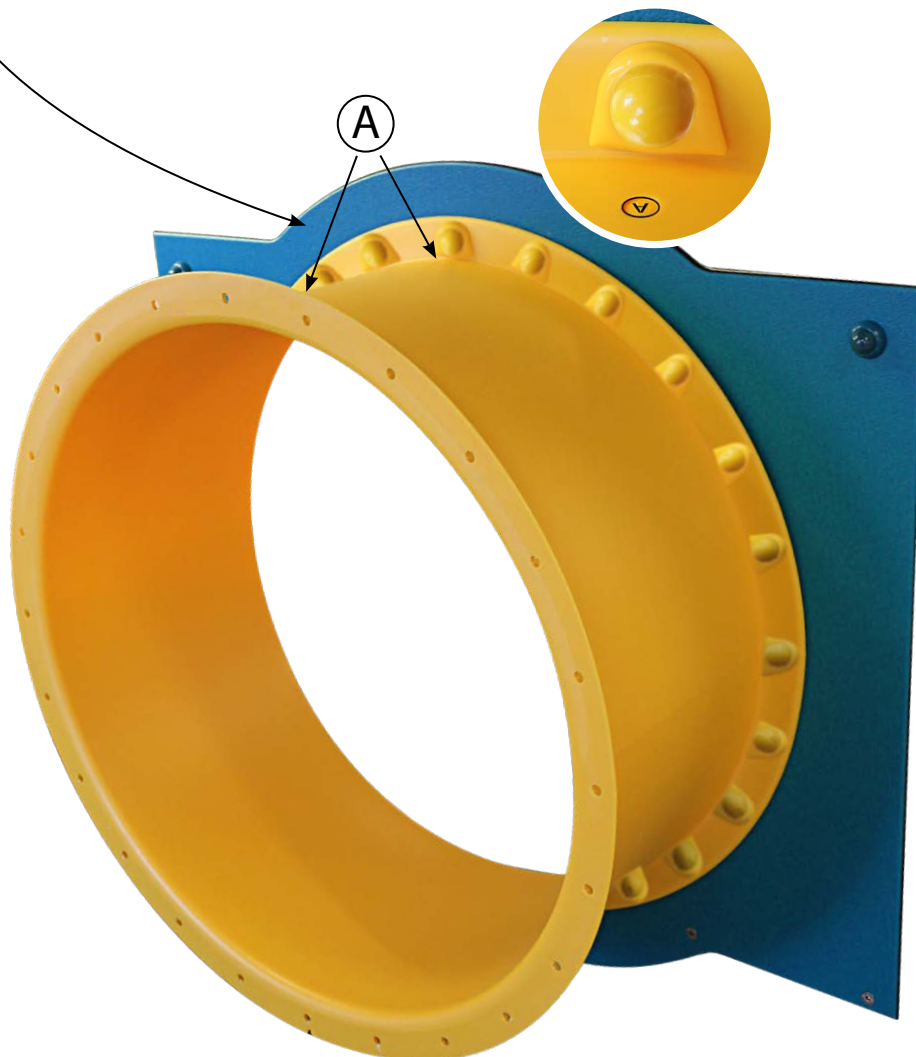
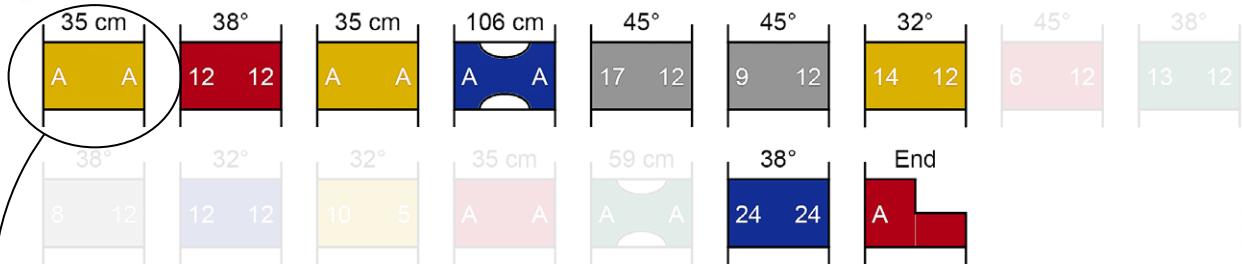

Tube assembly – general

The tubes are assembled in the correct sequence by aligning the numbers with the letters as shown in the LEDON Tunnel Maker assembly instructions.

Mounting guide:

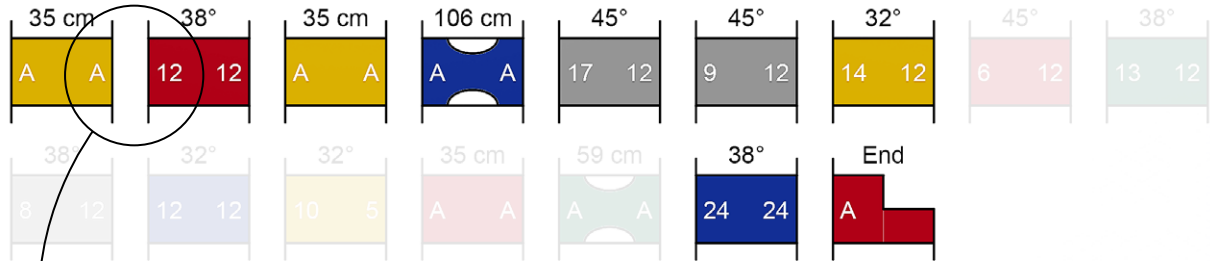

Window tube assembly

Follow LEDON's assembly instructions to ensure that the windows are positioned correctly and do not become a sliding surface.

Windows must sit on the tubes in either a '10 o'clock' or '2 o'clock' position.

Mounting guide:

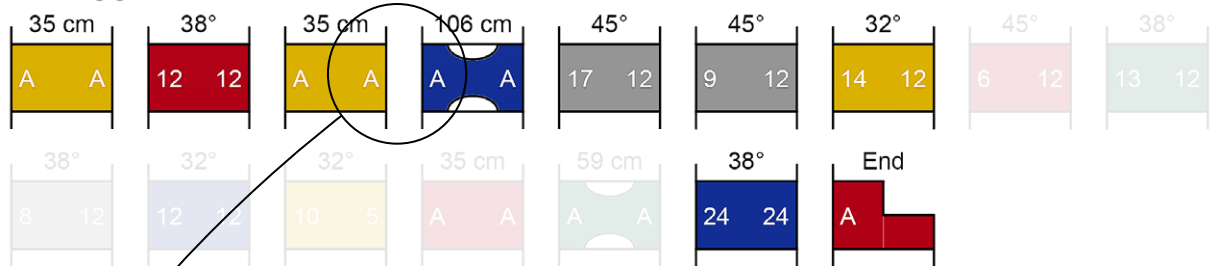

Tube assembly – finishing

Important: Assemble the second-to-last tube and the exit chute to create a single section before attaching it to the rest of the tube slide.

Mounting guide:

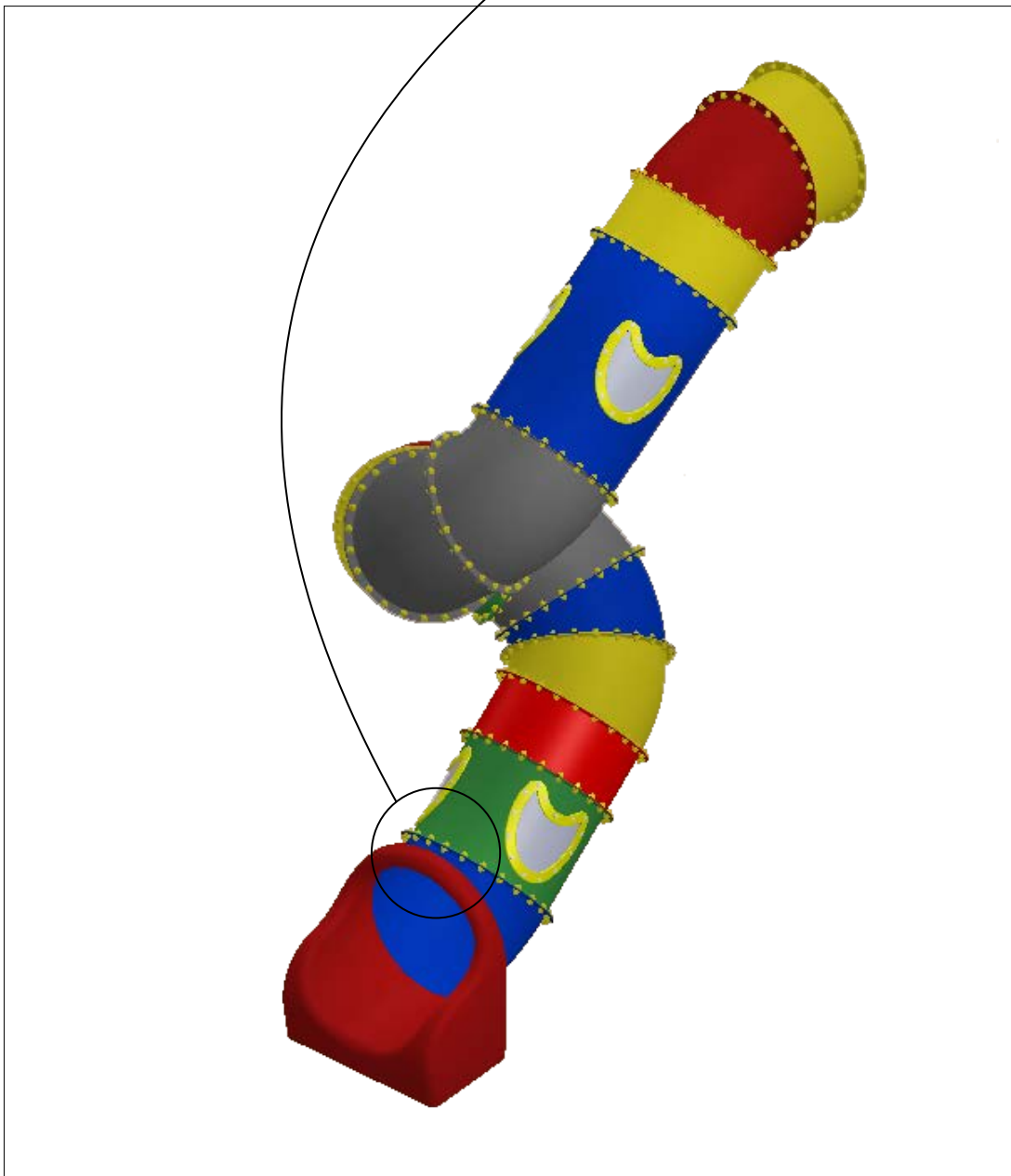
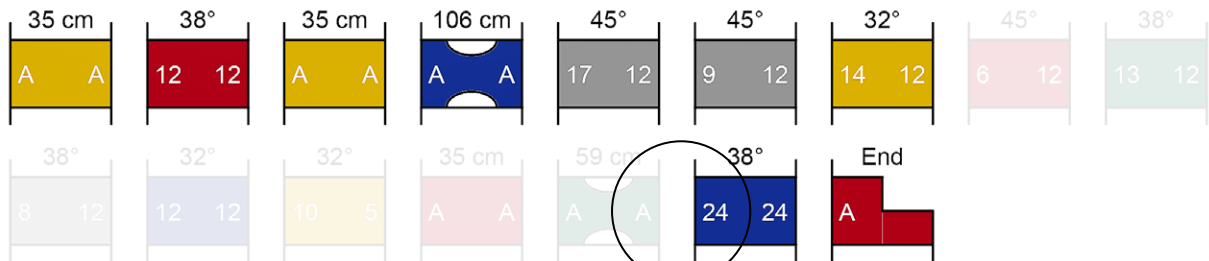

Exit chute

Important: Assemble the second-to-last tube and the exit chute to create a single section before attaching it to the rest of the tube slide.

Mounting guide:

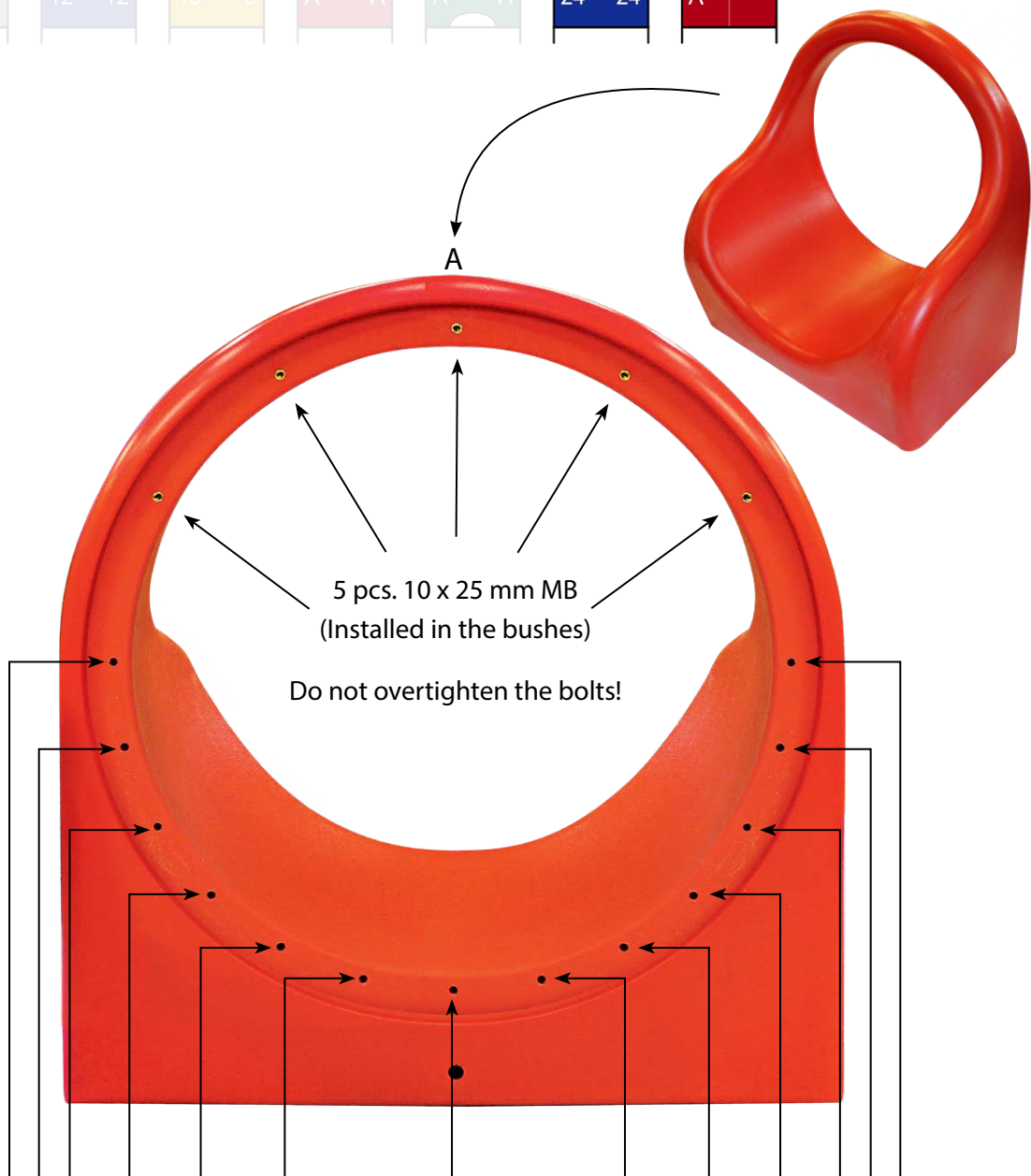
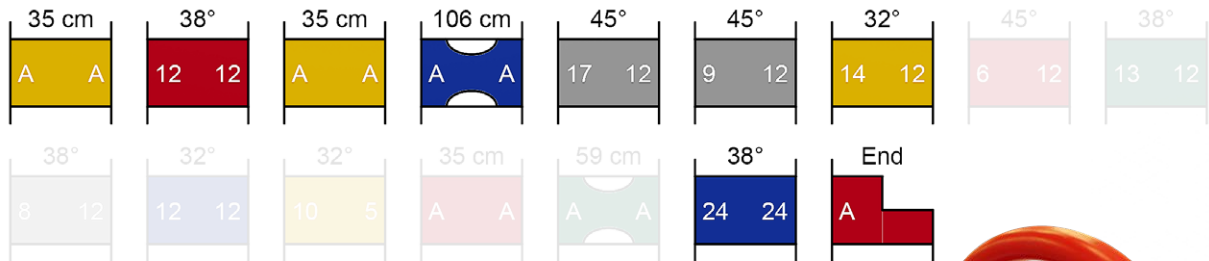

13 pcs. 10 x 40 mm MB + 13 x 10,5 x 30 mm SEK

Exit chute

Attach the second-to-last tube so that the '24' is sitting uppermost on the tube. As in this example.

Mounting guide:

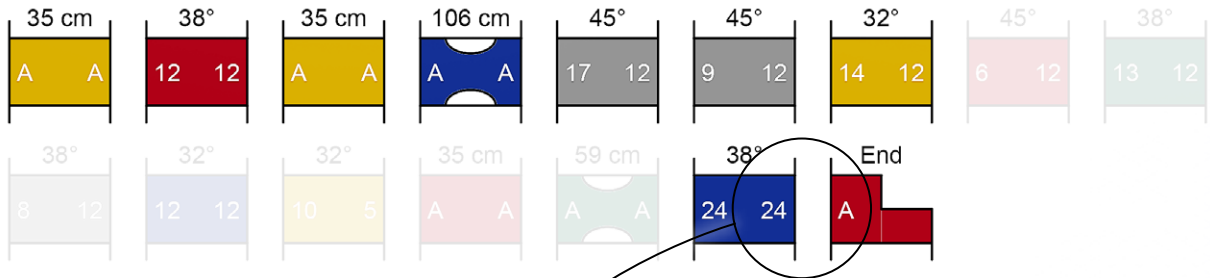

5 pcs. 10 x 25 mm MB
(Installed in the bushes)

Do not overtighten the bolts!

Exit chute

Install the other bolts.

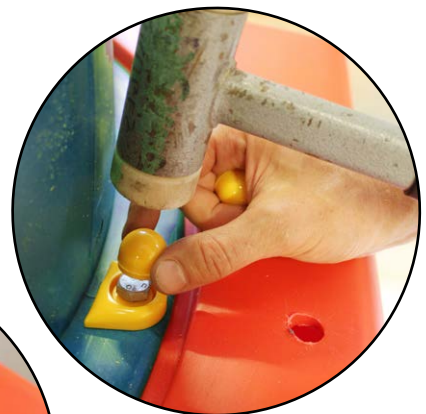
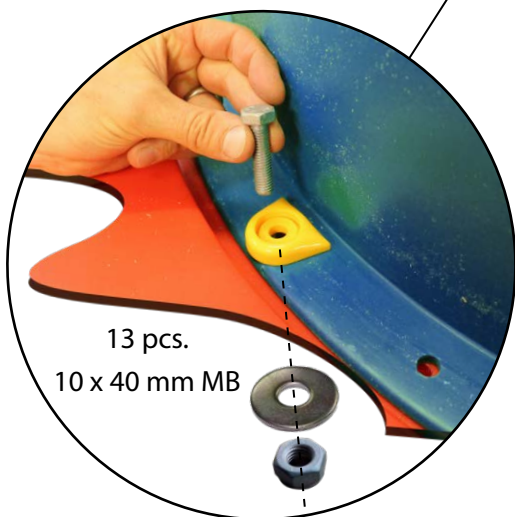

Exit chute – installation of anchoring

Installation of anchoring – for trenching.

For mounting on concrete – see page 19.



Exit chute – installation of anchoring

To ensure the stability of the anchoring and the exit chute, a PE-plate must be fitted INSIDE the exit chute and secured with a metal bracket and three bolts. See the picture below.

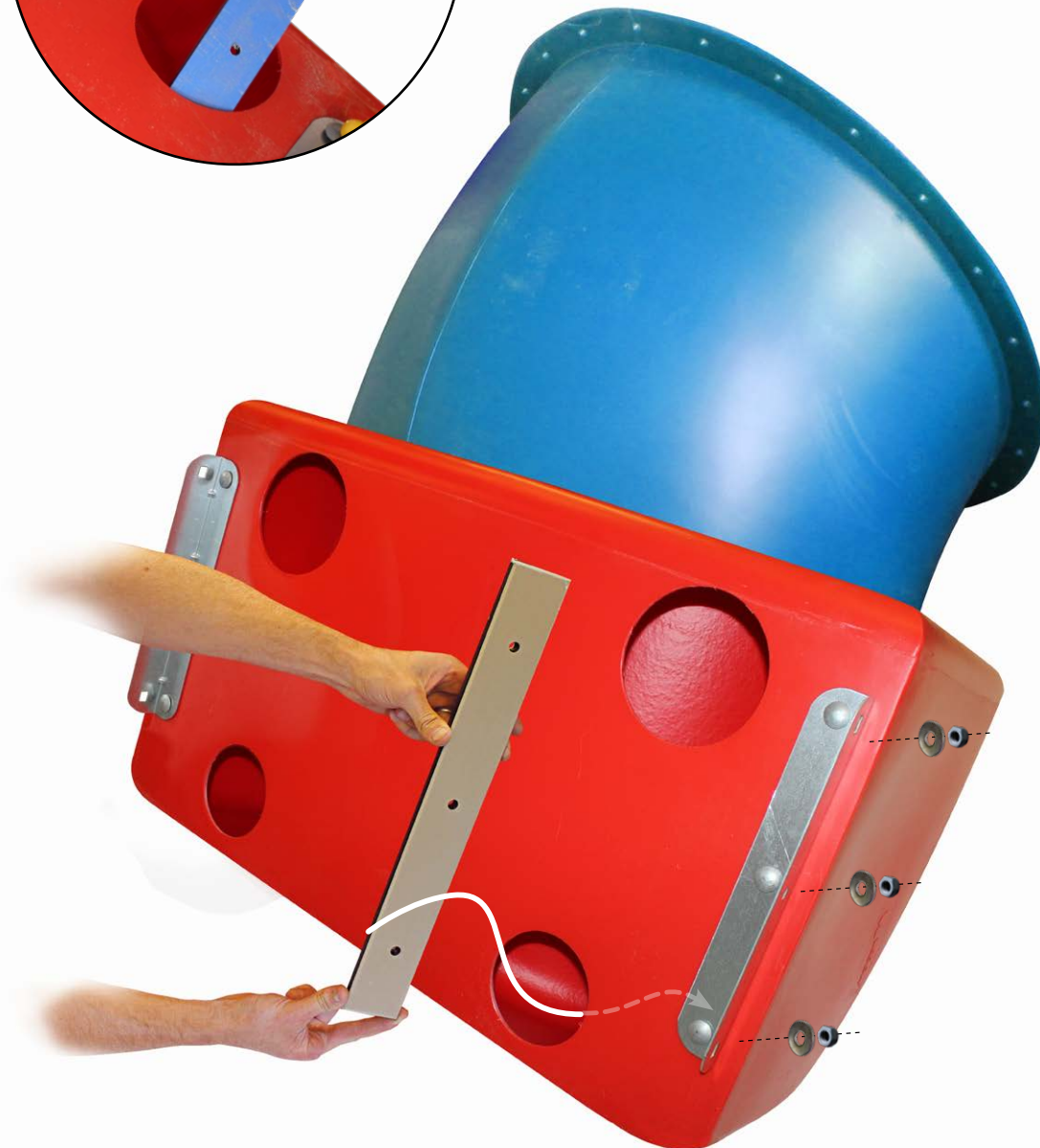

Exit chute – installation of concrete bracket

Installation of anchoring for concrete.

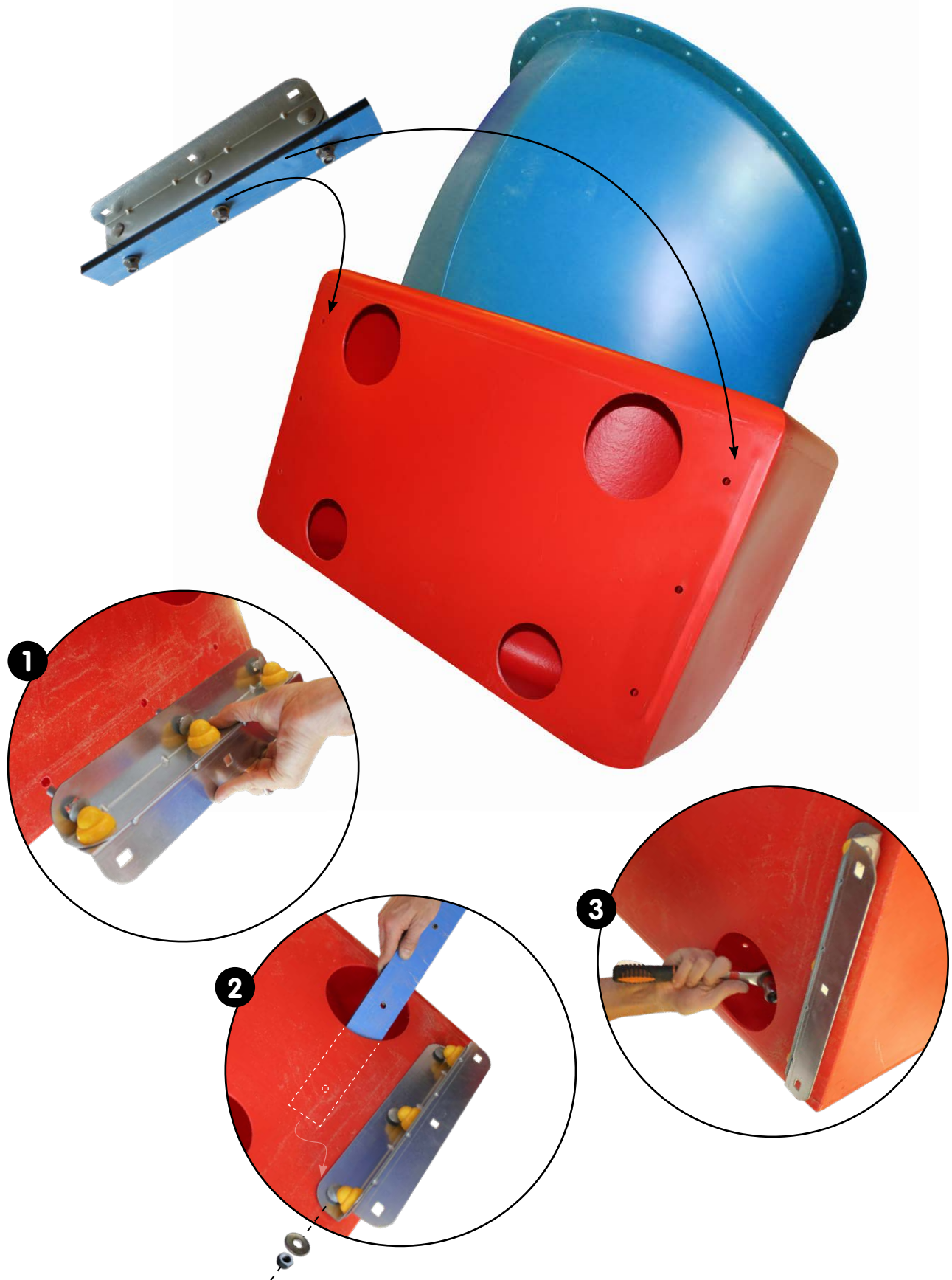

Installation of exit chute

Installation of exit chute **without** exit chute extension: See page 21

Concrete: See page 23

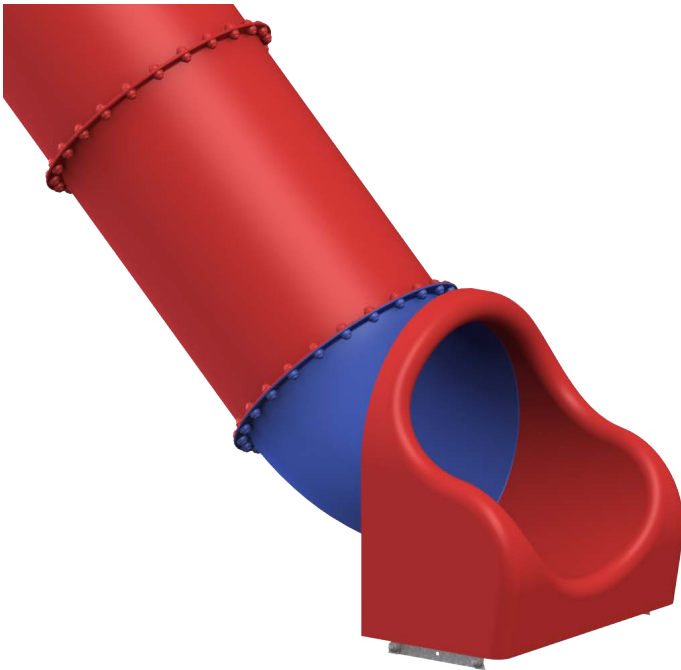

Installation of exit chute **with** exit chute extension: See page 25

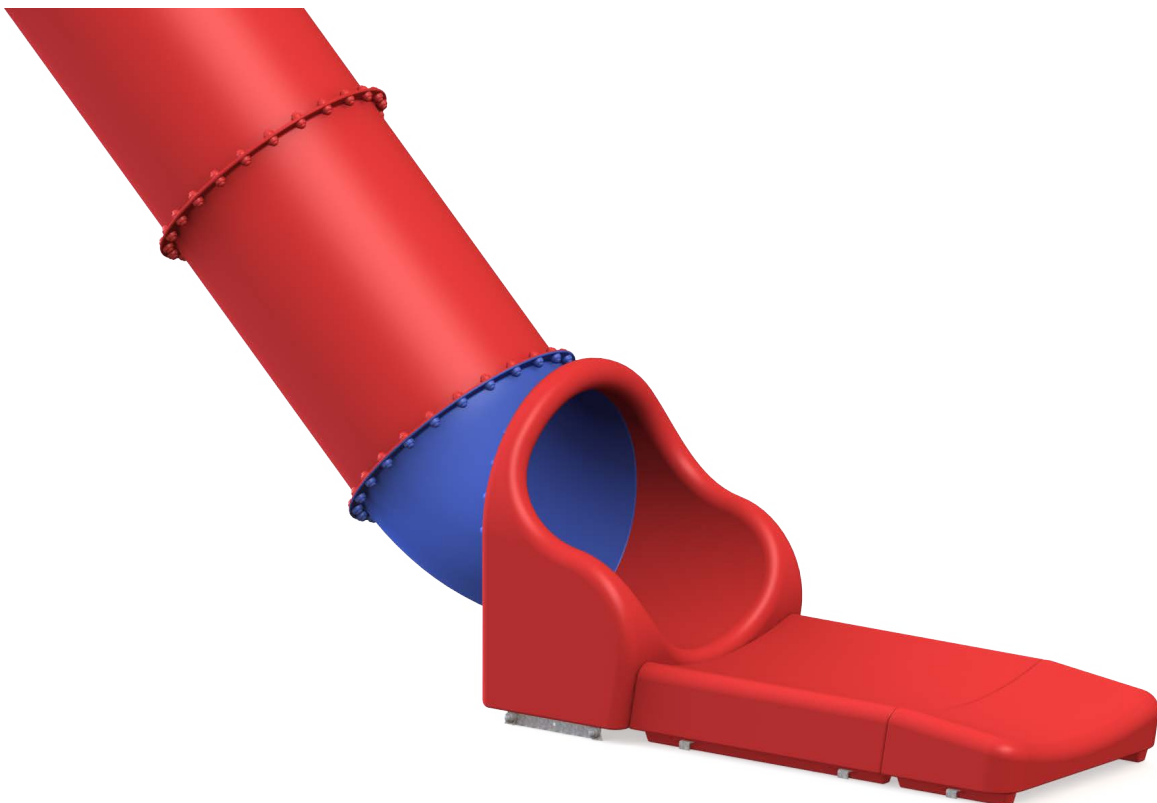

Trenching of ground anchor

Important: Do not dig a hole for the ground anchor until the tube slide is fully assembled. The tubes and exit chute must be correctly positioned with regard to support before digging a hole for the ground anchor. See drawing below.

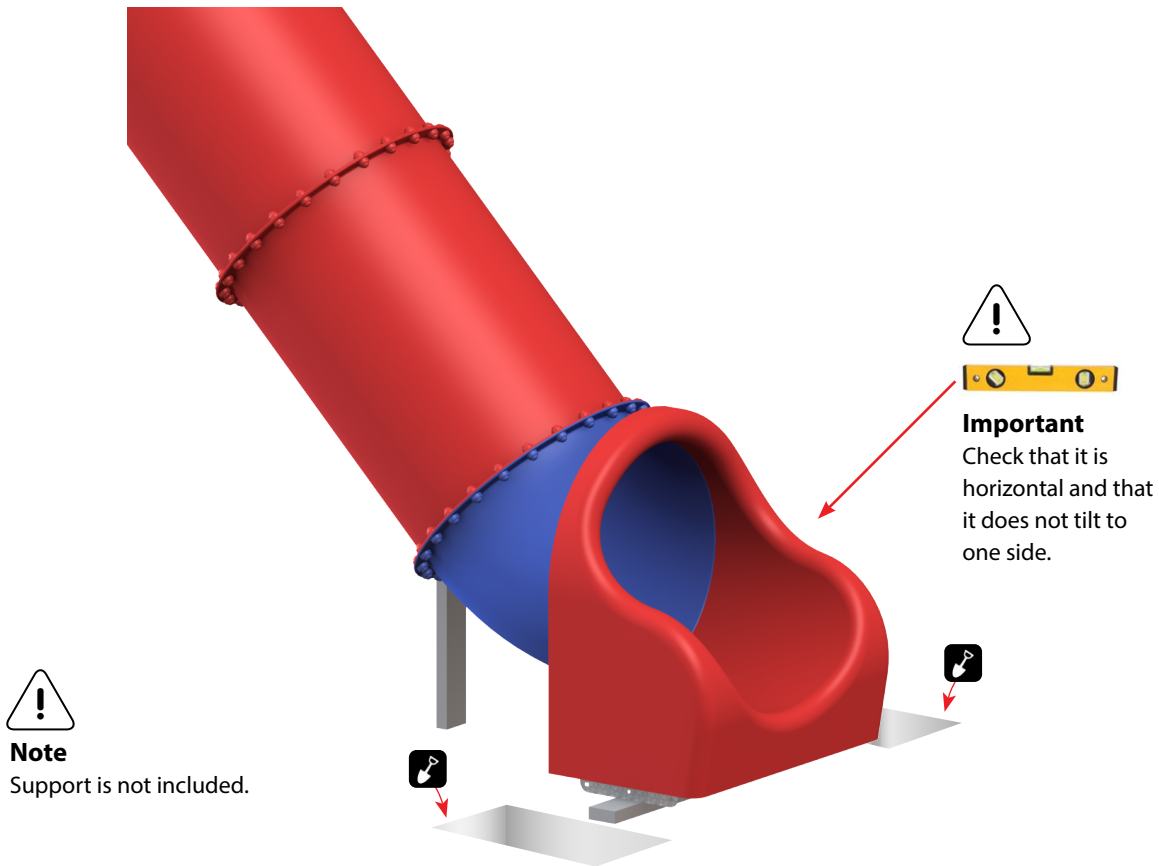

Drawing of hole

Digging depths • Grabtiefen • Gravedybder:

 50cm

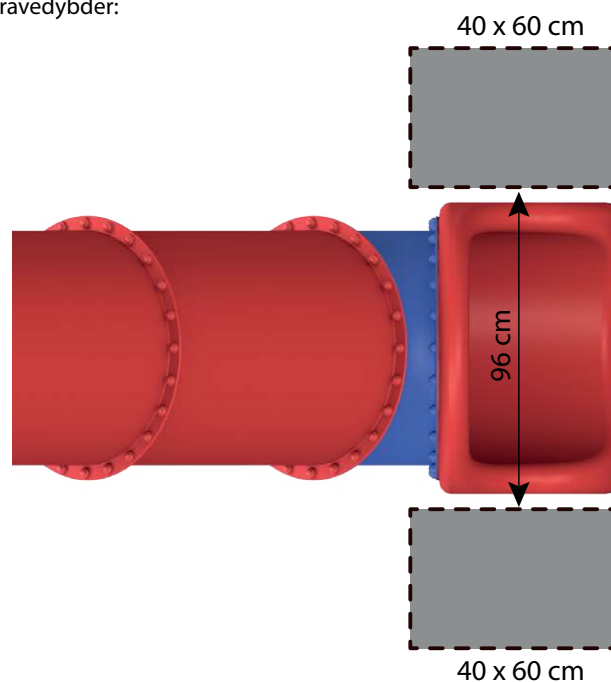

Note
The drawing is not to scale.

Trenching of ground anchor

Important: The ground anchor is fitted to the exit chute, and the support is subsequently removed from beneath it.

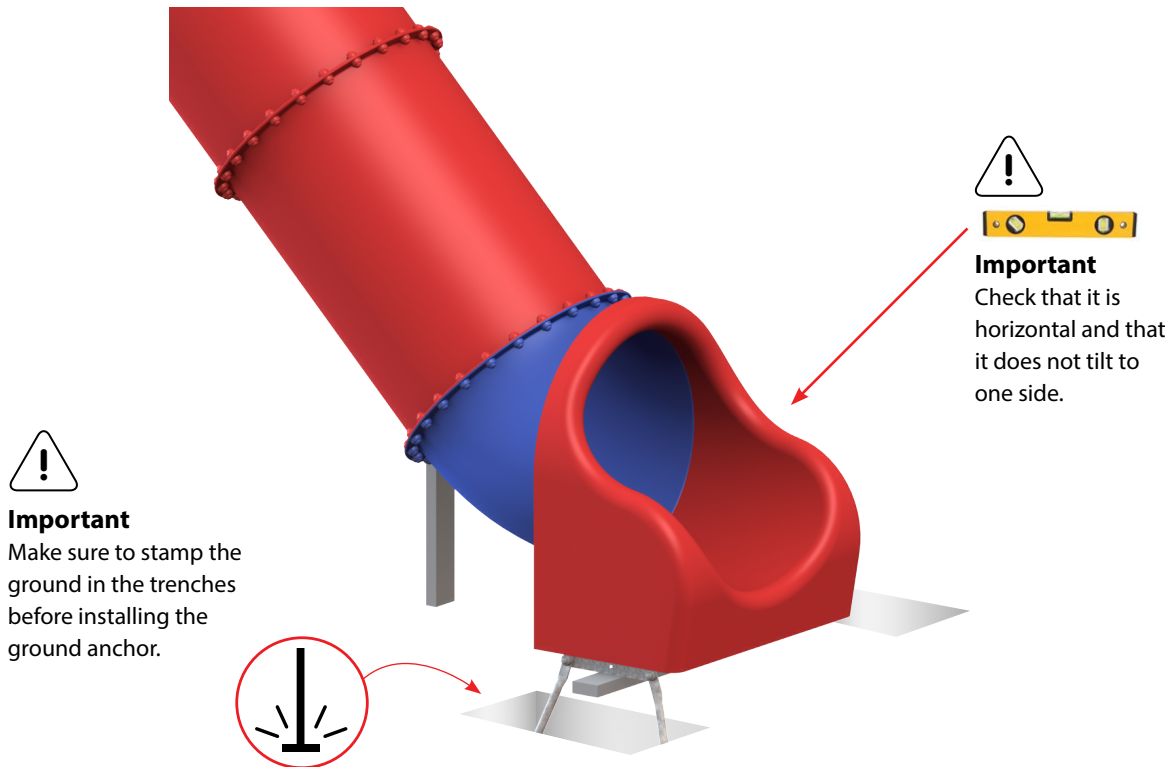

Installation of ground anchor to exit chute.

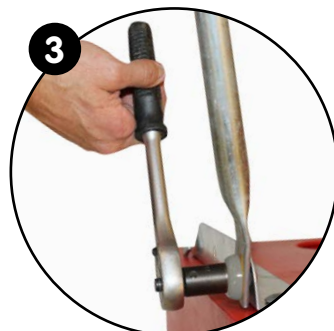
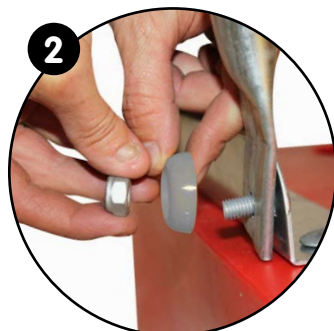
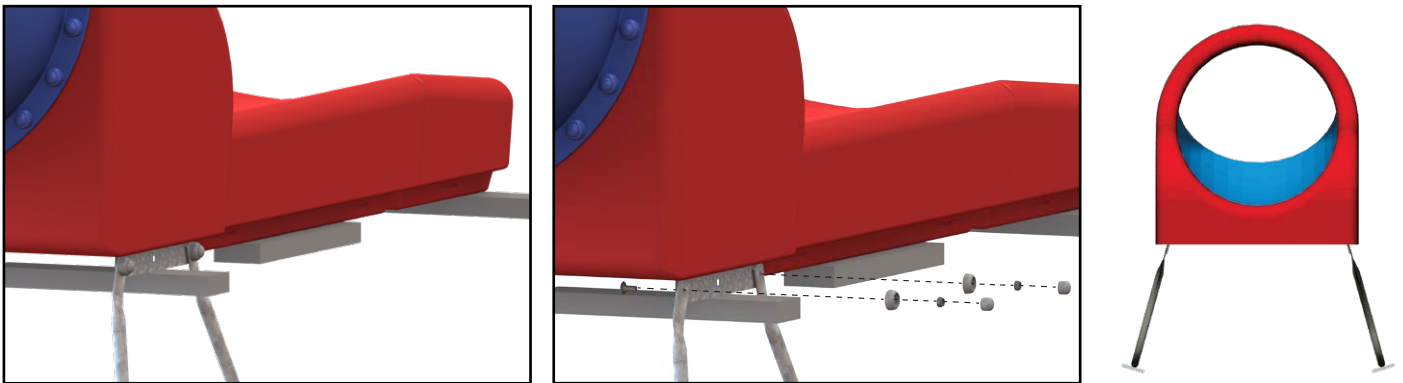

Exit chute – anchoring to concrete

Installation of anchoring – to concrete

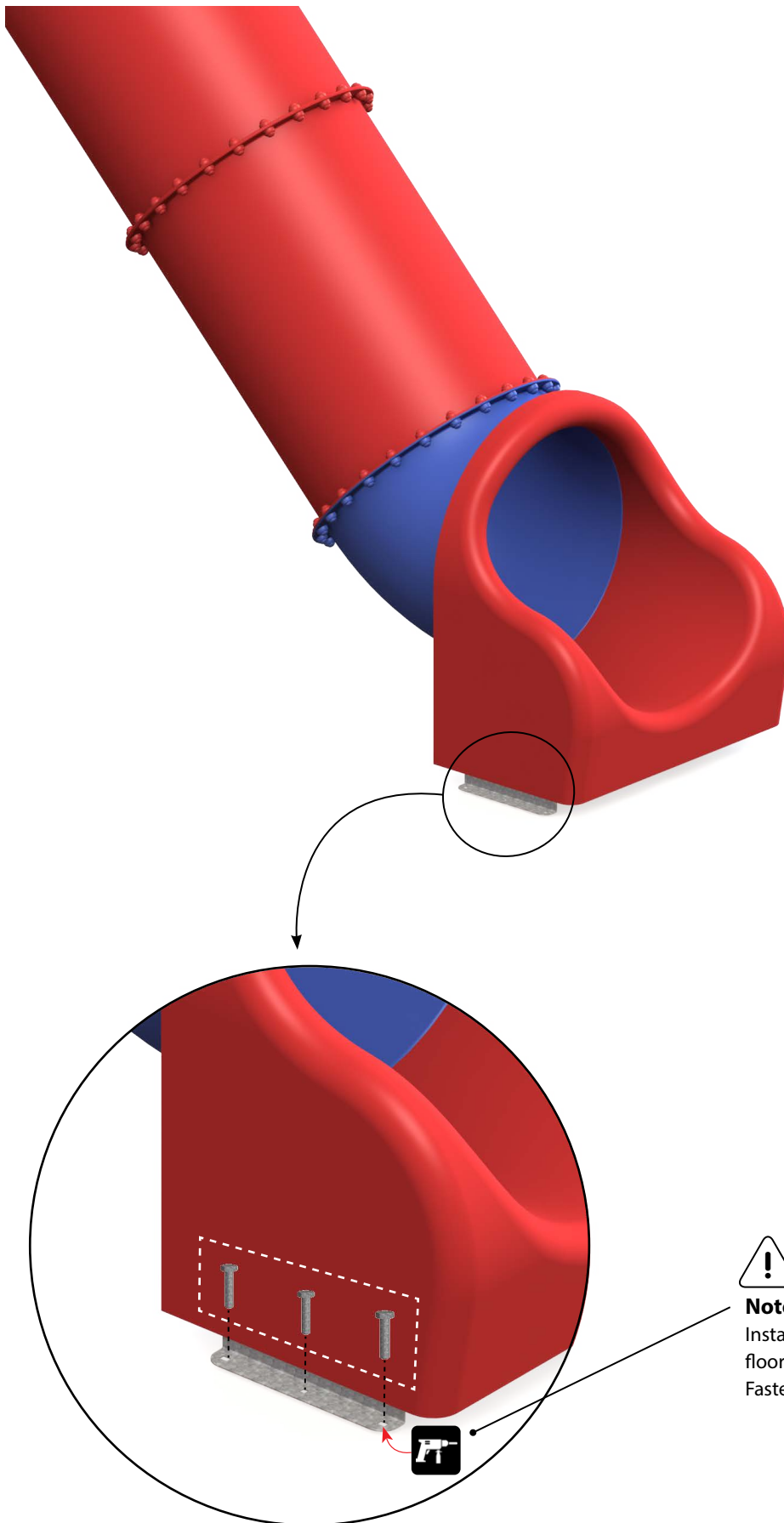

Note

Install in accordance with floor type.
Fastenings not included.

Finished tube slide



Assembly – exit chute extension

General assembly of exit chute and exit chute extension: See assembly instructions on page 26

Ground anchoring of exit chute + exit chute extension: See installation instructions on page 30

Concrete anchoring of exit chute + exit chute extension: See installation instructions on page 34



LEDON exit chute extension – proven quality

- The new exit chute can be extended indefinitely
- Fire tested in accordance with EN 71-2
- Impact-resistant (between -40° to $+80^{\circ}$ C)
- Low maintenance, non-toxic polyethylene (PE)

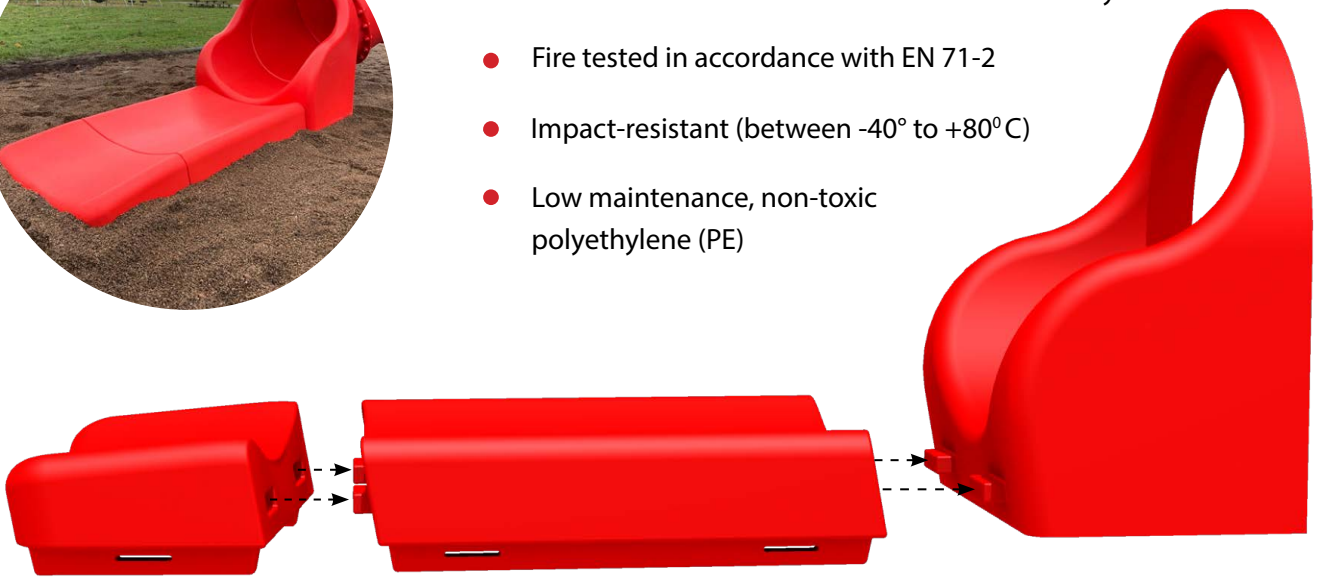

Colour options:

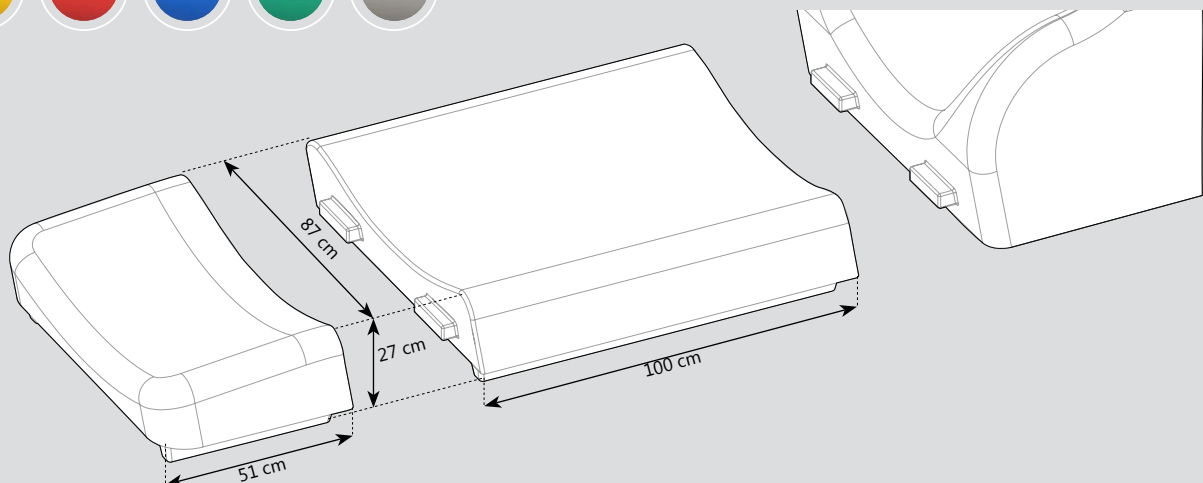

Positioning of exit chutes

Step 1: The tubes and exit chute must be correctly positioned in relation to support – check that the support is horizontal before bolting together in step 2.

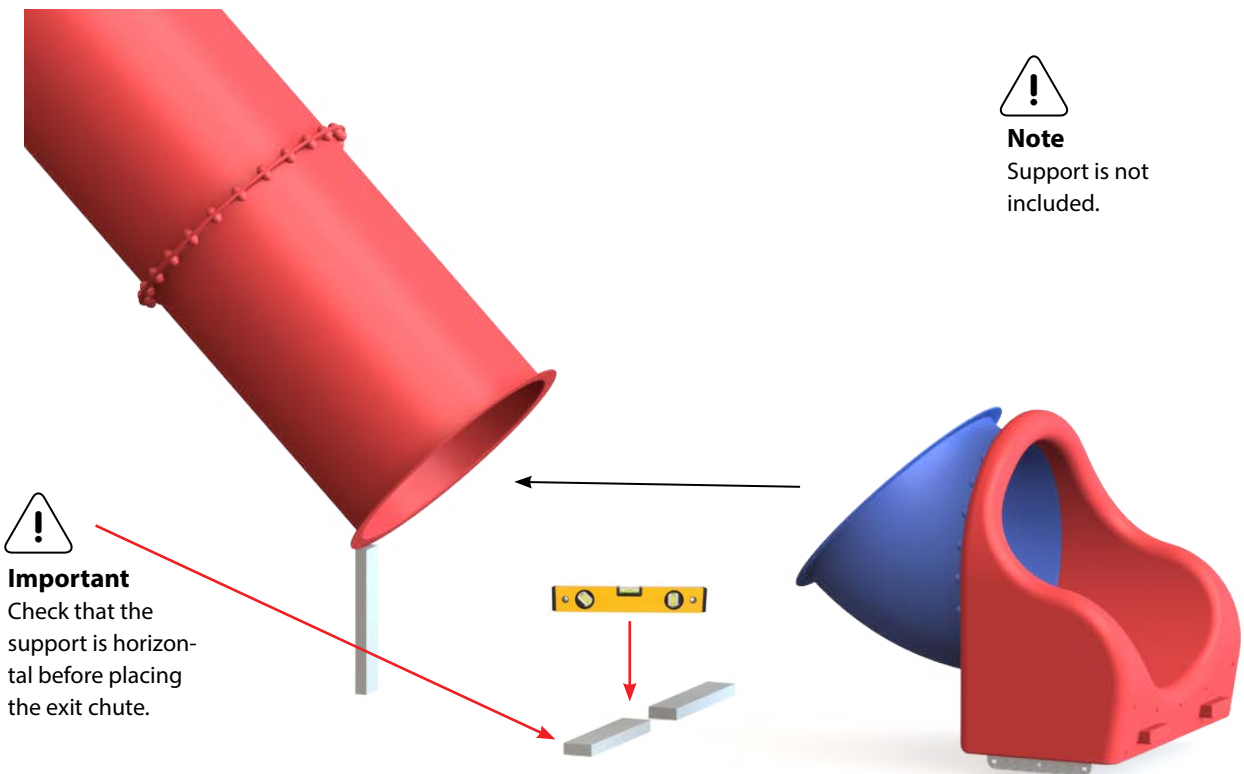

Step 2: Four bolts are fitted to check that the positioning is horizontal and that it does not tilt to the sides.

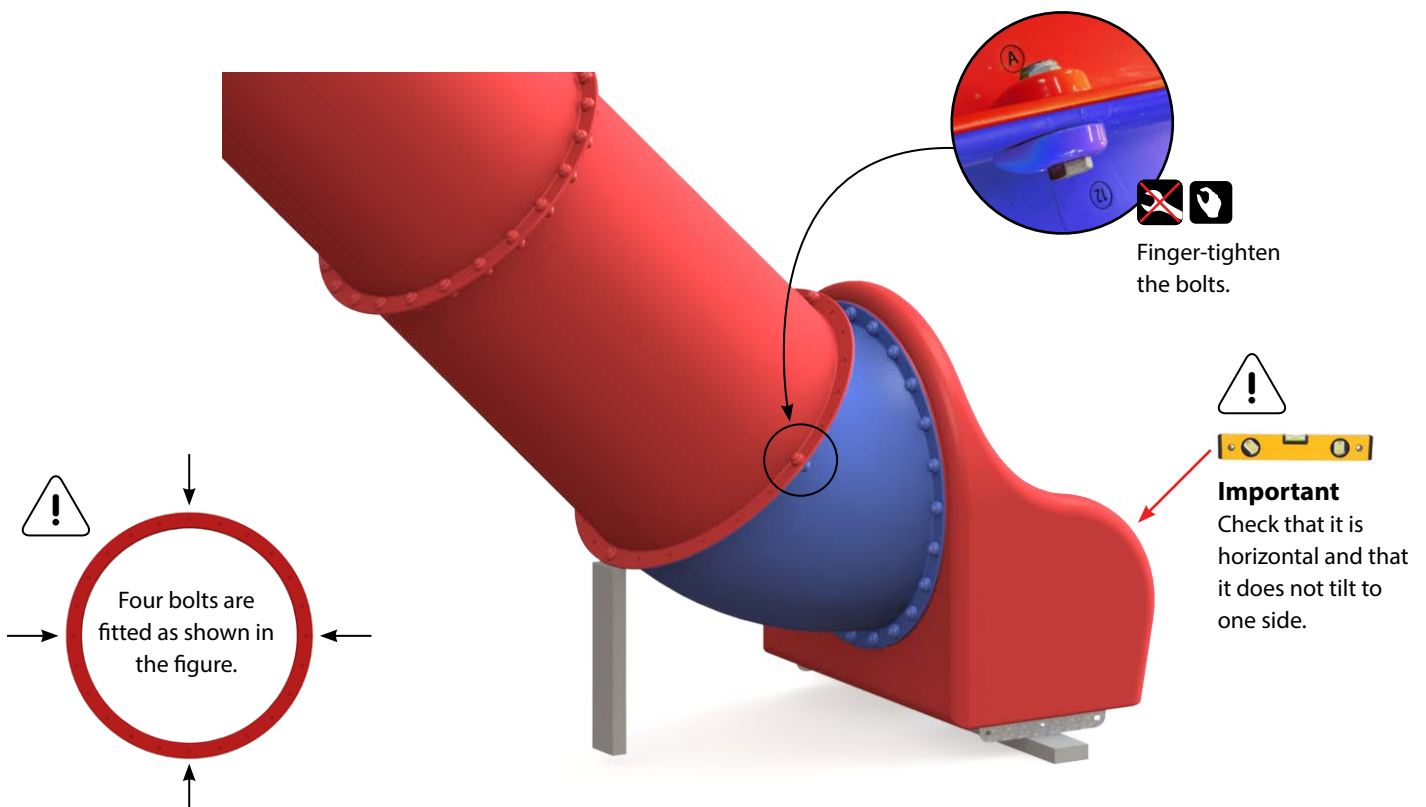

Positioning of exit chutes

Step 3: If the exit chute is not positioned correctly in step 2, proceed to step 3. Remove the exit chute, and drill out all the holes around the joint with the accompanying drill bit. Then repeat step 2 to correctly position the exit chute.

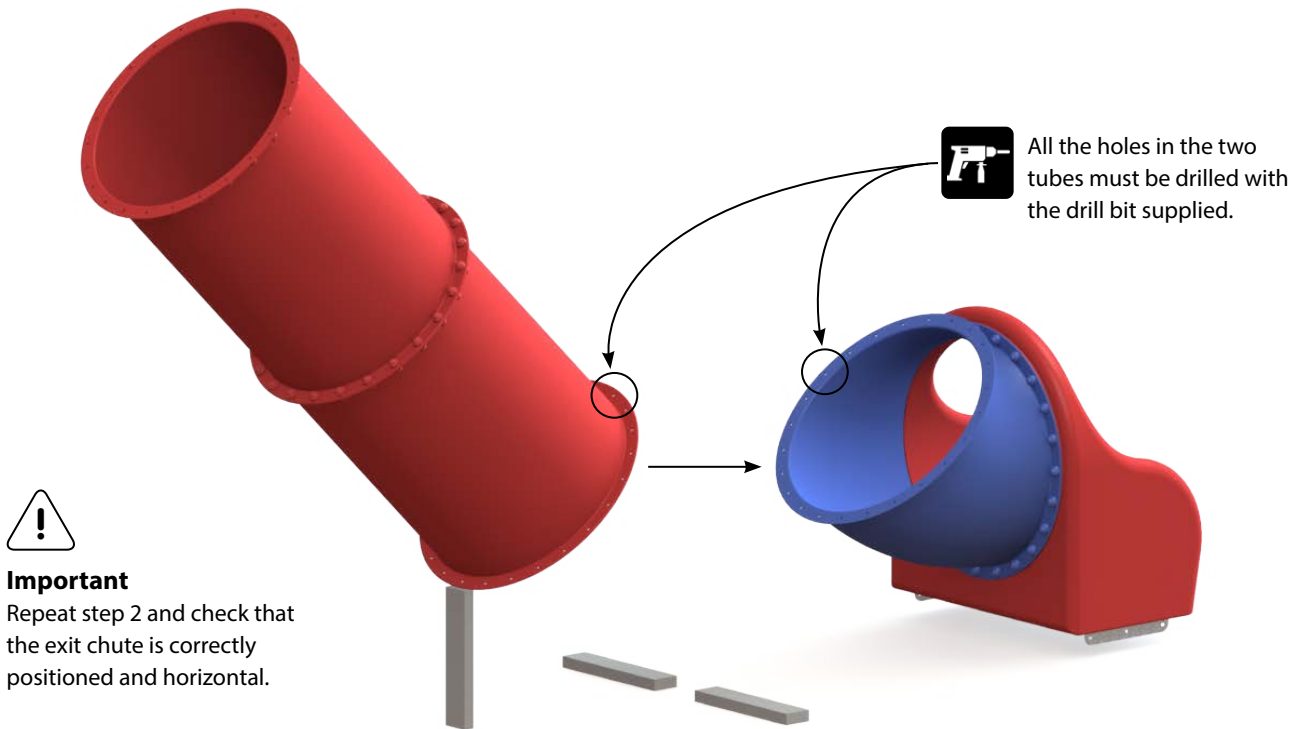

Step 4: Remove the four bolts and then carefully remove the exit chute from the tube slide. Make sure to keep the tube slide in the same position when disassembling the exit chute.

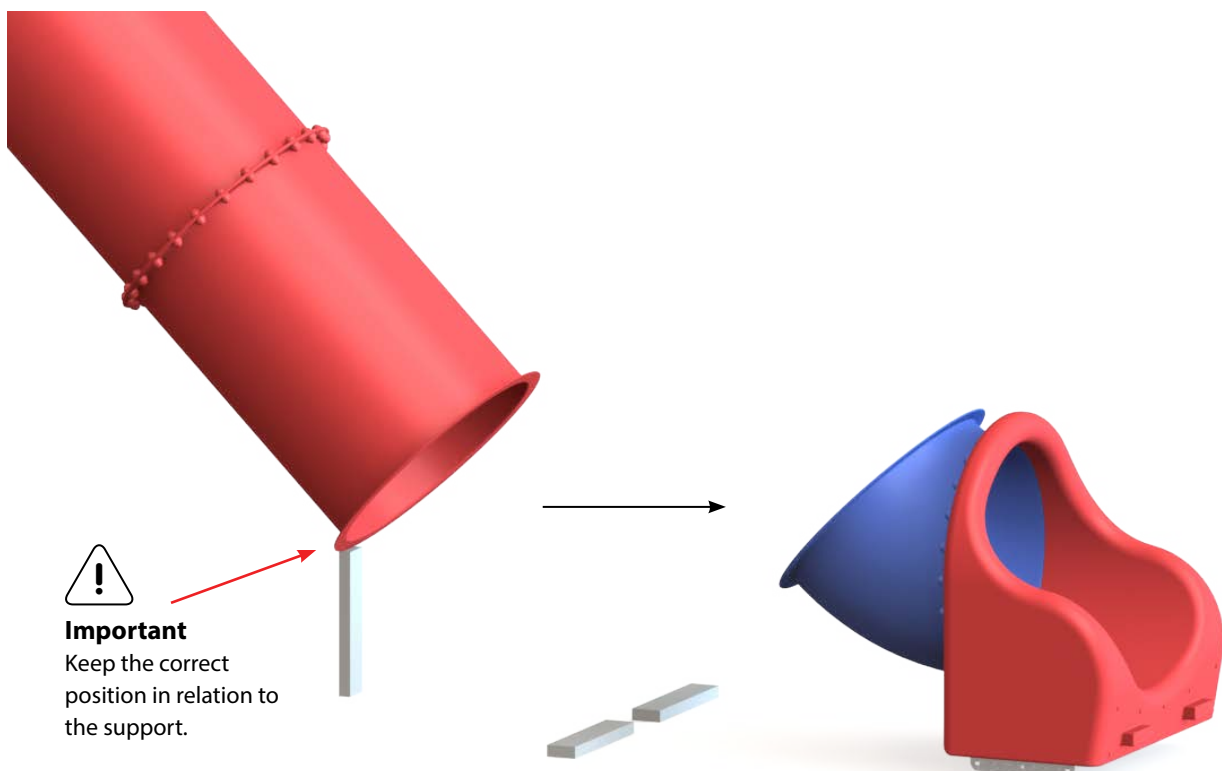

Installing the exit chute extension

Step 5: The exit chute and exit chute extension are placed on their sides and pushed together.

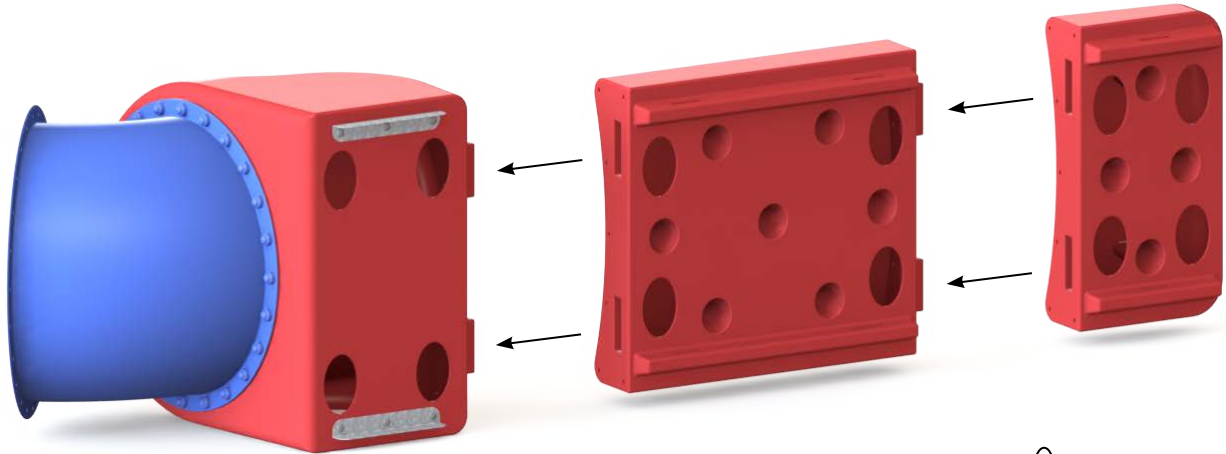

Important

Place the exit chute modules on the side during assembly.

Step 6: Bolt the exit chute and exit chute extension together.



M10x35 HX
Ø 35mm WS
M10 LN

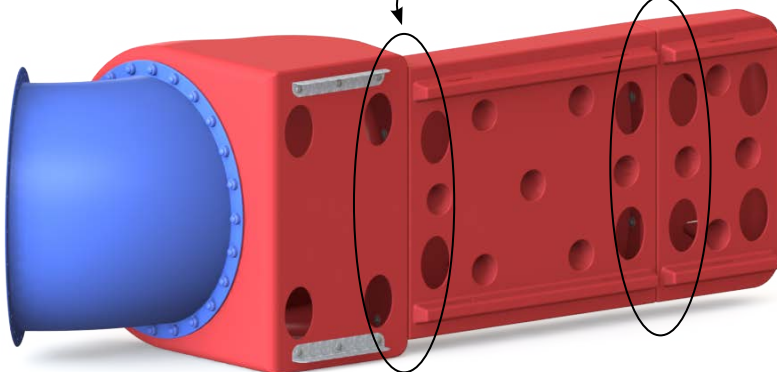
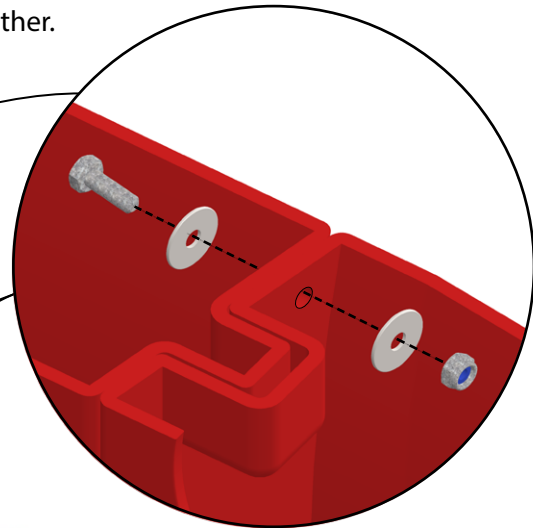

Important

Use all seven holes to bolt the modules together.

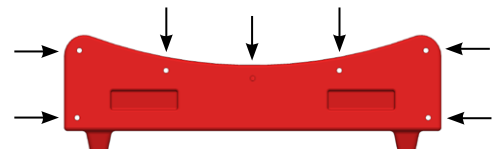

Positioning – exit chute and exit chute extension

Step 7: The exit chute and exit chute extension are placed in the correct position.

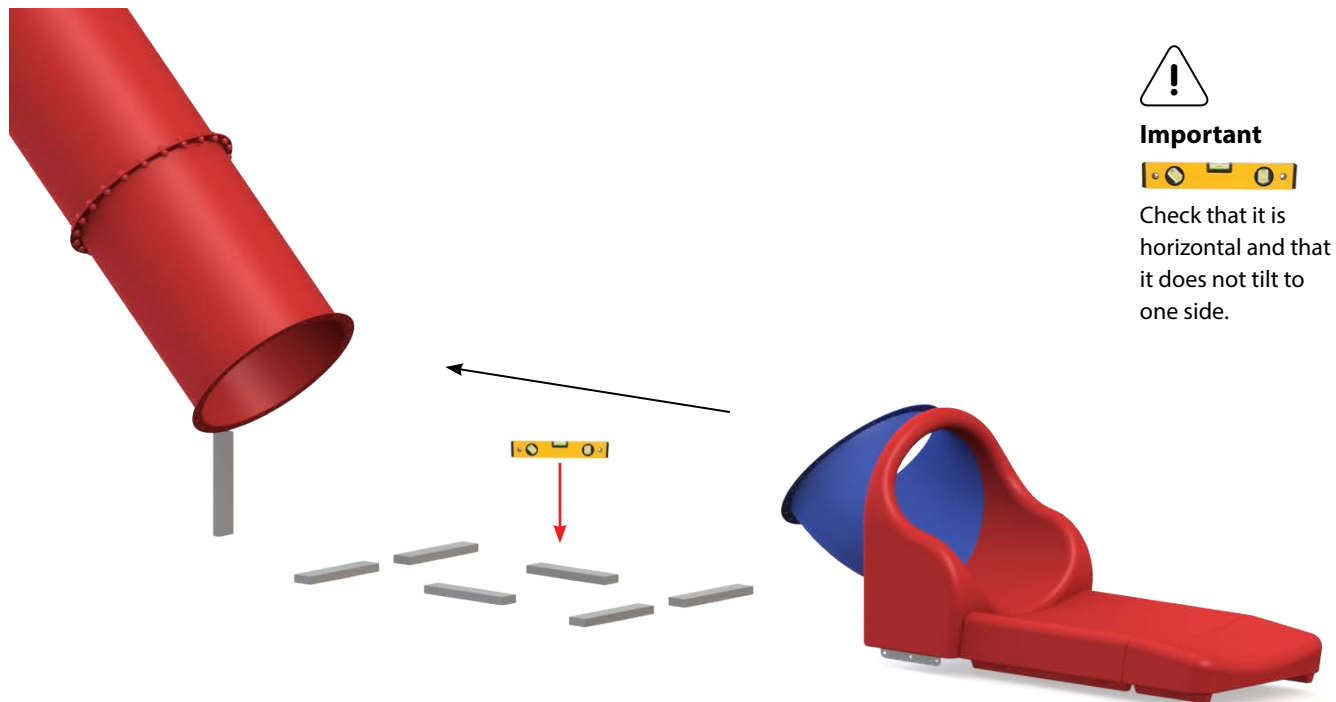

Important



Check that it is horizontal and that it does not tilt to one side.

Step 8: Fit the bolts all the way around.

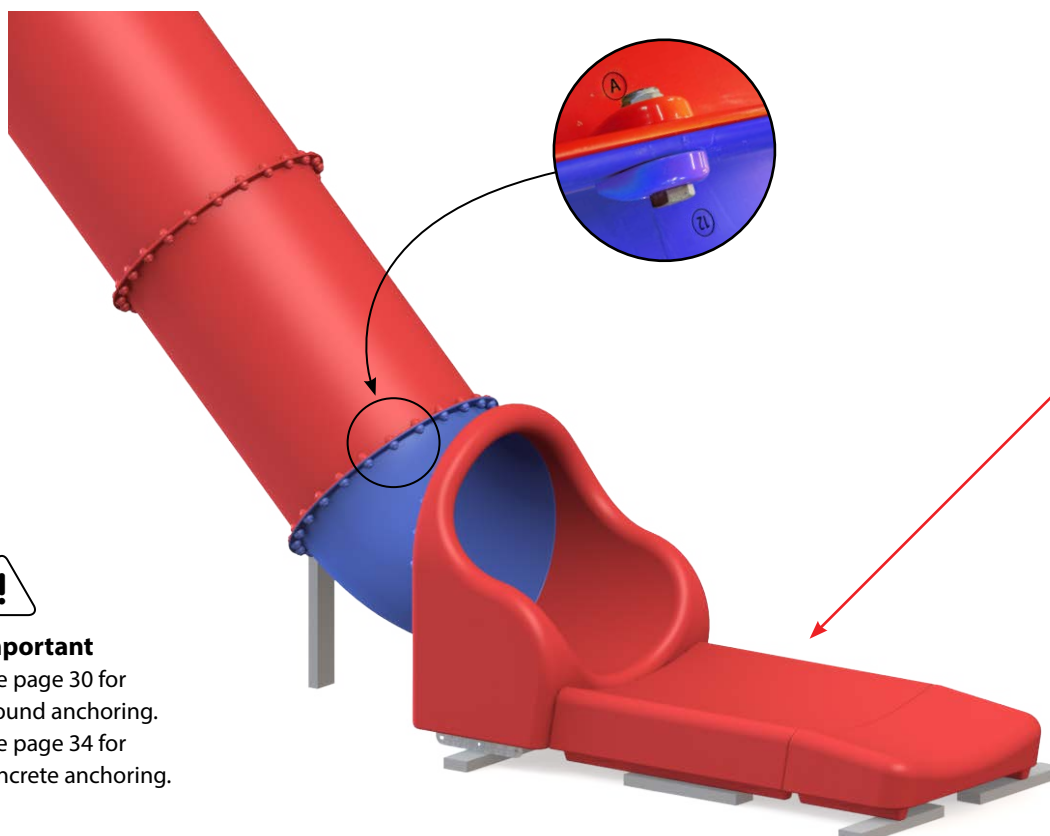

Important

See page 30 for ground anchoring.
See page 34 for concrete anchoring.



Important

Check that it is horizontal and that it does not tilt to one side.

Trenching for ground anchoring

Step 9: Dig trenches alongside the exit chute modules.

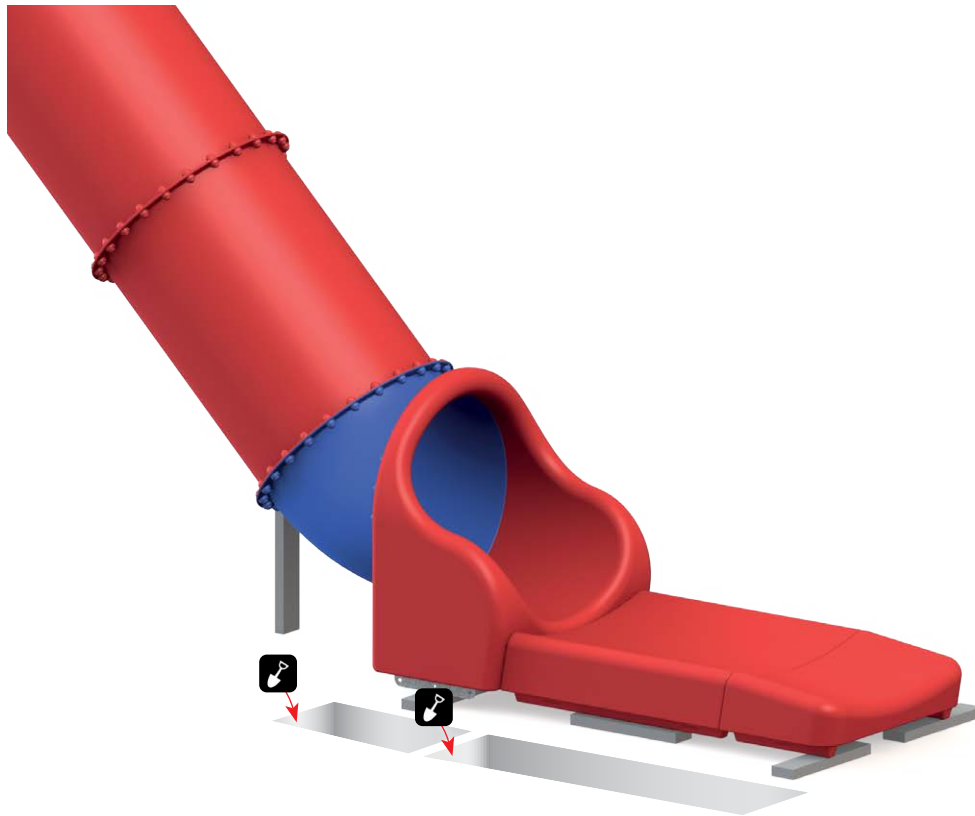

Important

If there are several exit chute modules, dig longer trenches as required.

Step 9: Drawing of hole

Digging depths • Grabtiefen • Gravedybder:

 50cm

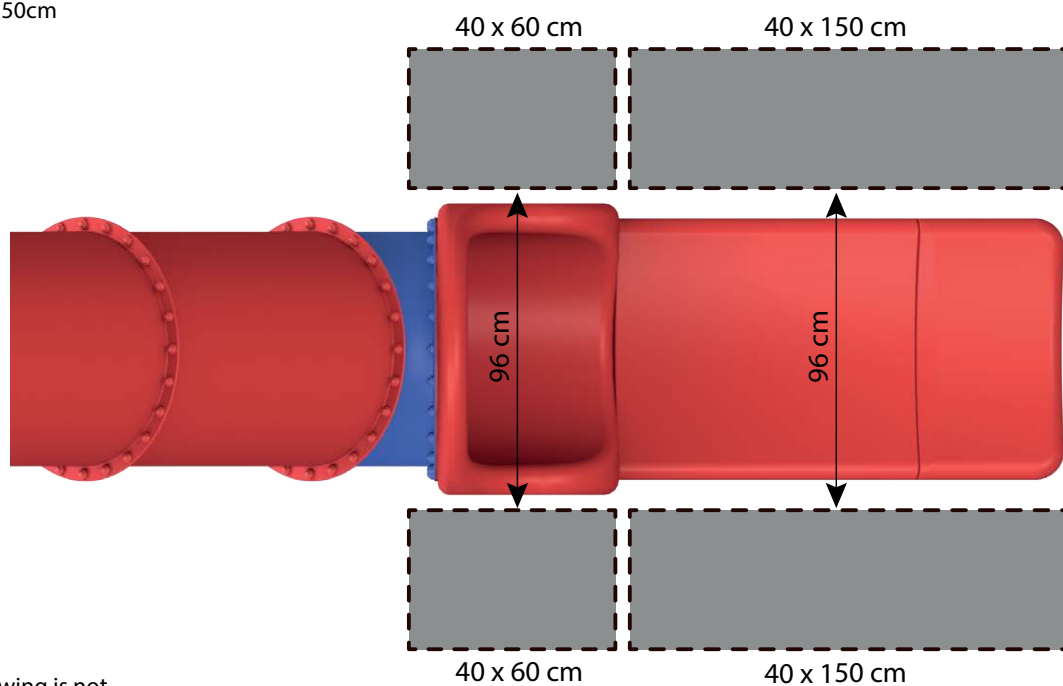

Note

The drawing is not to scale.

Trenching of ground anchor

Step 10: The ground anchor is fitted to the exit chute, and the support is subsequently removed from beneath it.

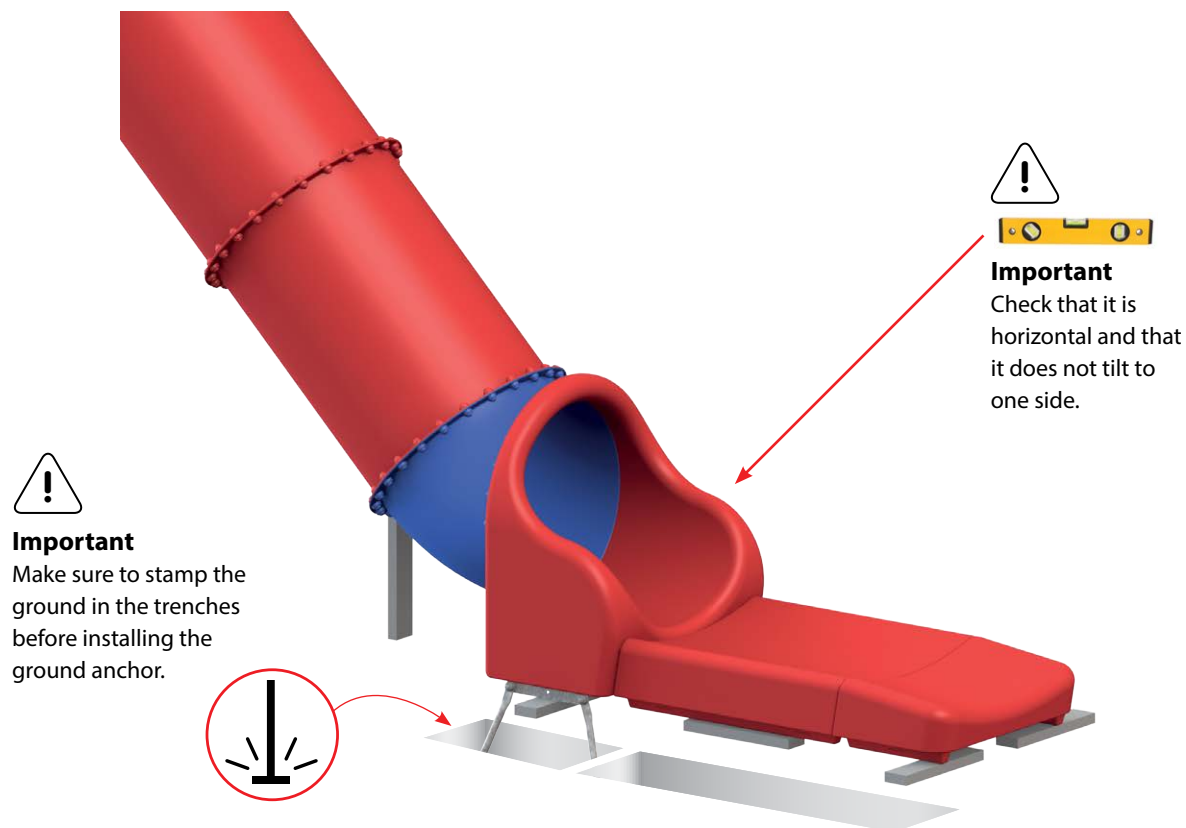

Step 10: Installation of ground anchor to exit chute.

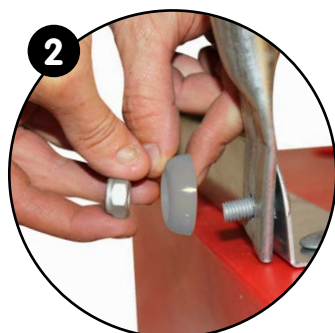
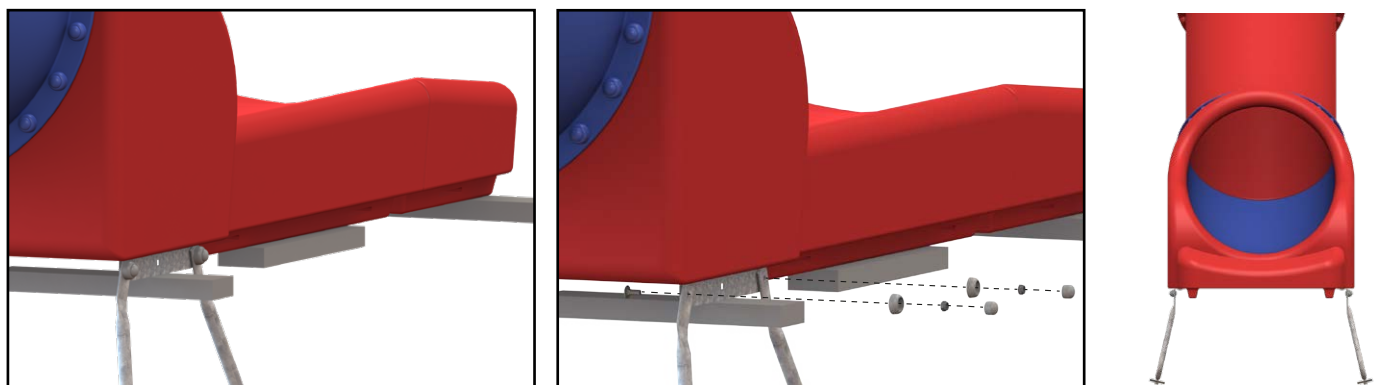

Trenching of ground anchor

Step 11: The ground anchor is fitted to the exit chute extension modules, and the support is subsequently removed from beneath the exit chute. See the instructions below.

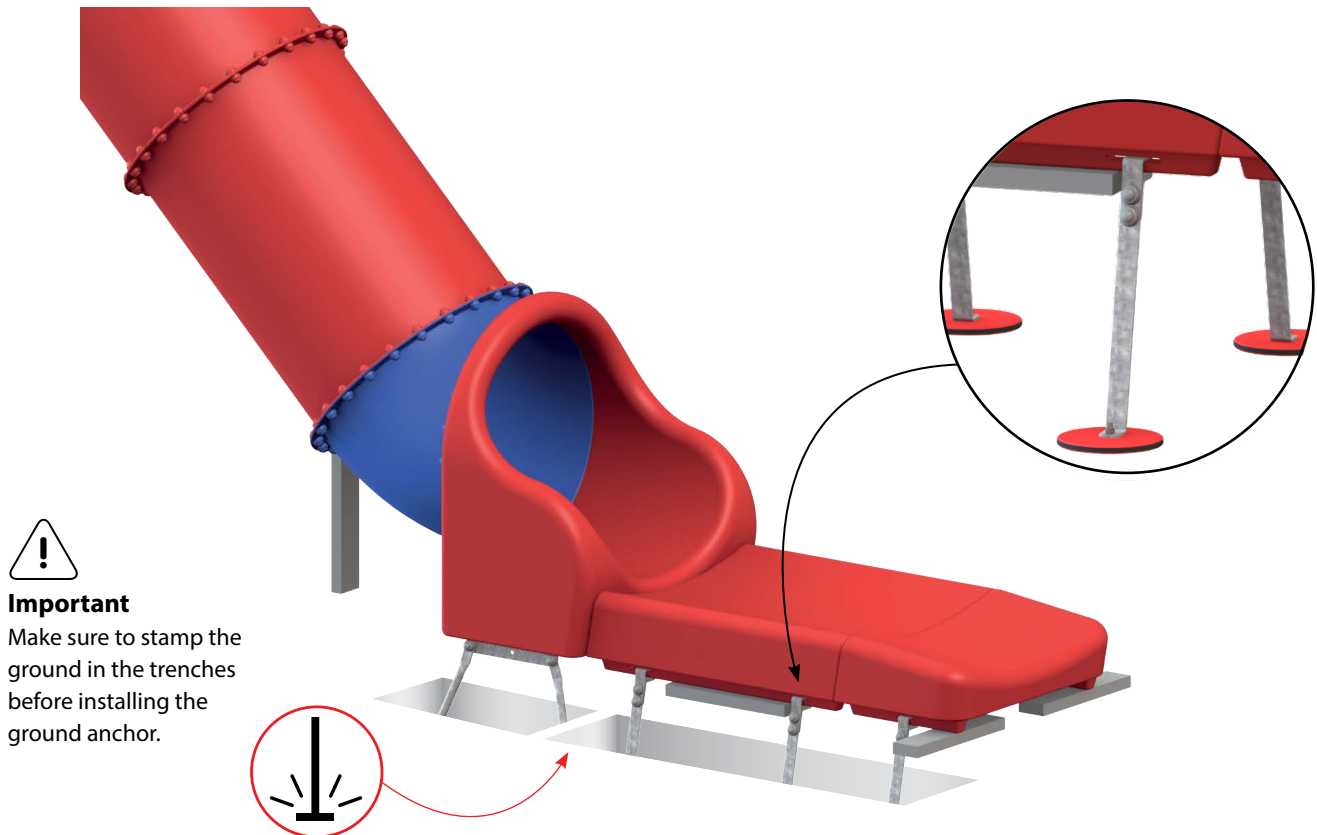

Step 11: Fitting of ground anchor to exit chute extension.

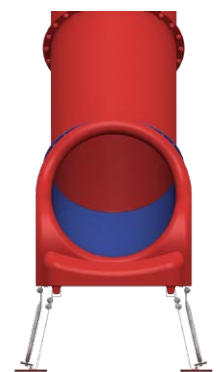
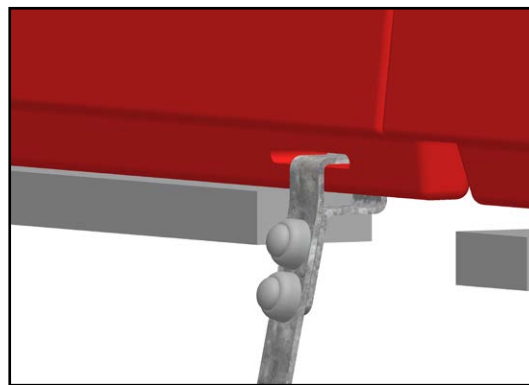
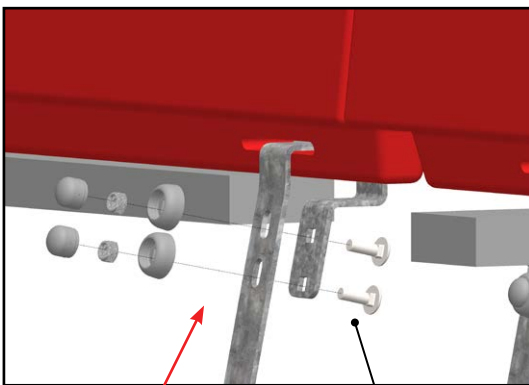

M10x30 CA
M10 LN



Important

Please note that the ground anchor fitting is mounted in the middle of the exit chute extension.

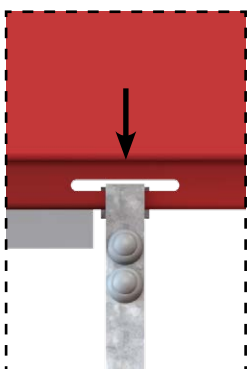

Adjusting and trenching the ground anchor

Step 12: Adjust the exit chute modules so that are standing correctly, and then fill up the holes with soil before stamping the ground.

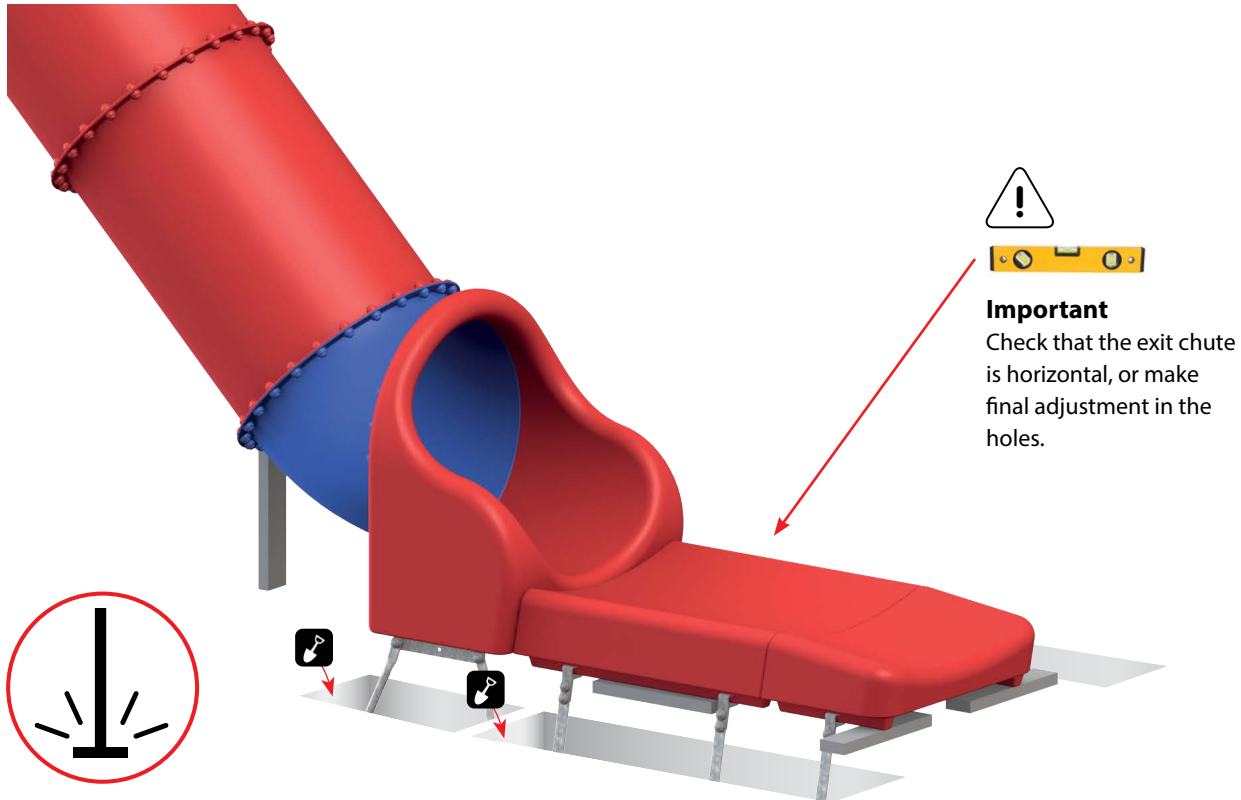

Finished tube slide

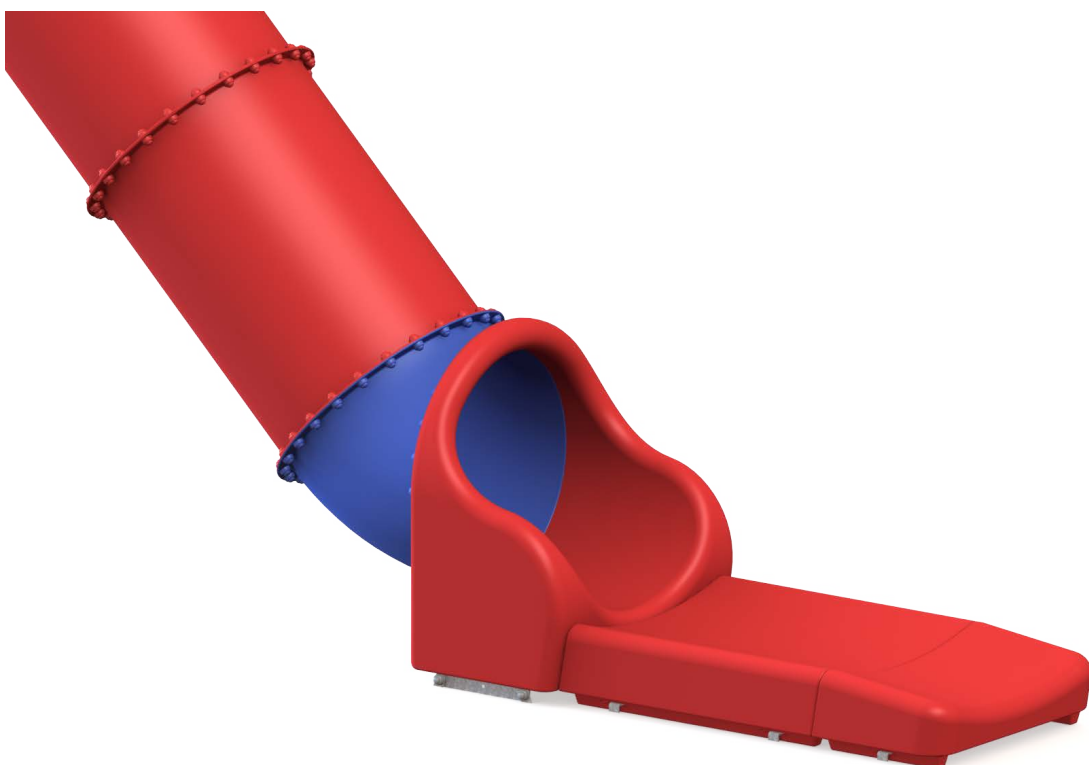

Exit chute – anchoring to concrete

Step 13: Installation of anchoring – to concrete

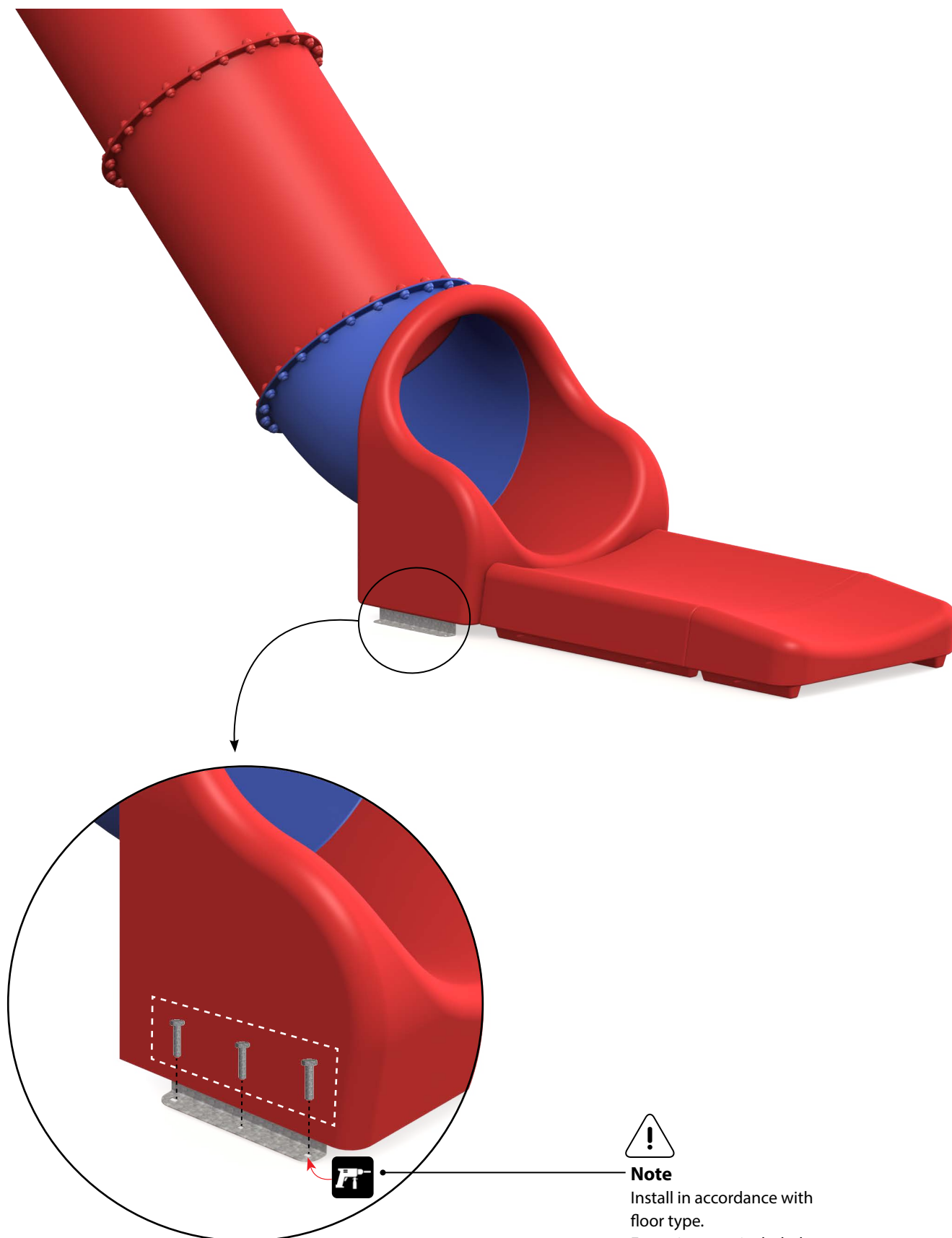

Note

Install in accordance with floor type.
Fastenings not included.

Exit chute extension – anchoring to concrete

Step 14: Concrete brackets for the exit chute extension modules are mounted and secured according to floor type.

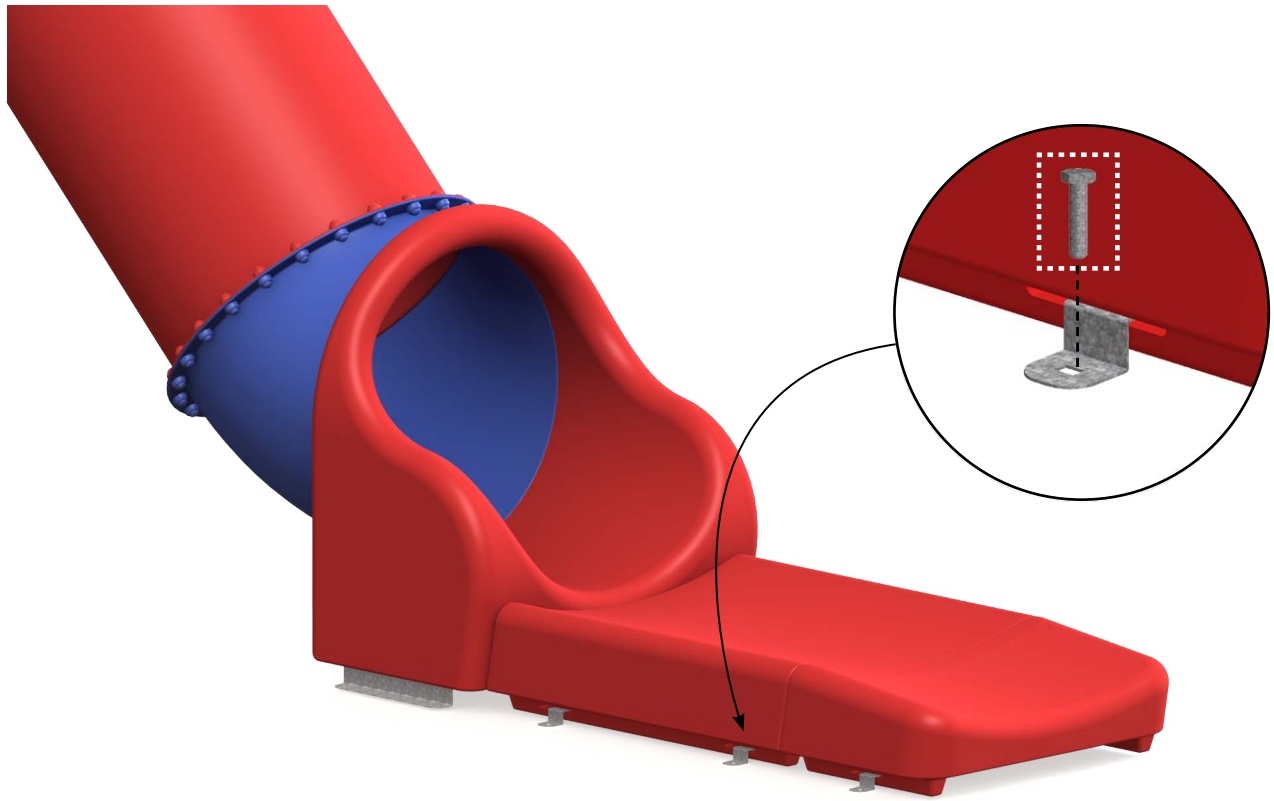

Step 14: Installation of concrete brackets for exit chute extension.

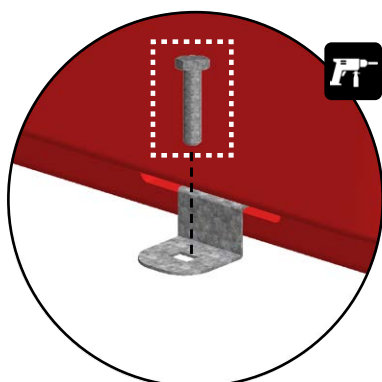
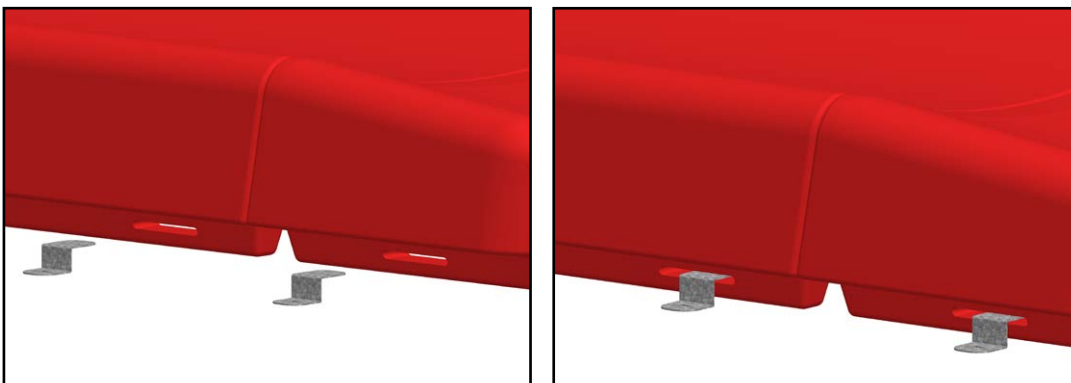

Note
Install in accordance with
floor type.
Fastenings not included.

Installation of support posts for tube slide

Mount post to bracket

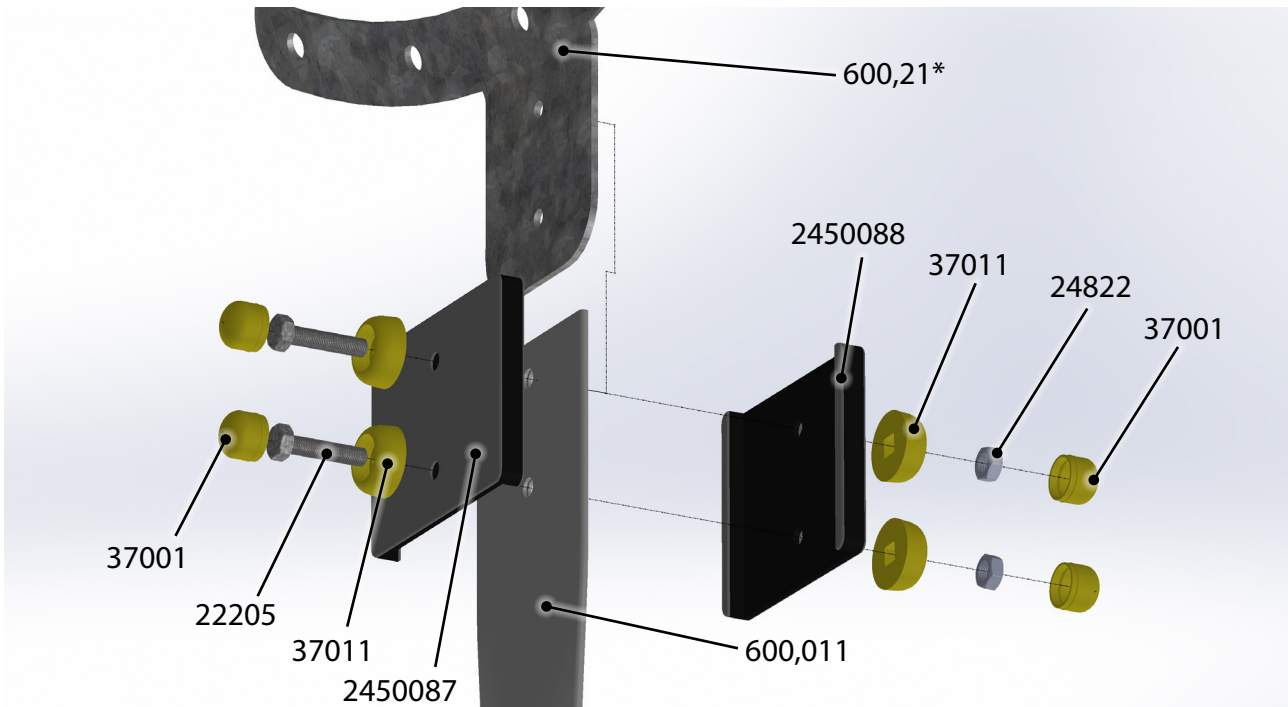

* Available in the following bendings:

600,21 = 25°

600,22 = 32°

600,24 = 38°

Mount bracket to flange

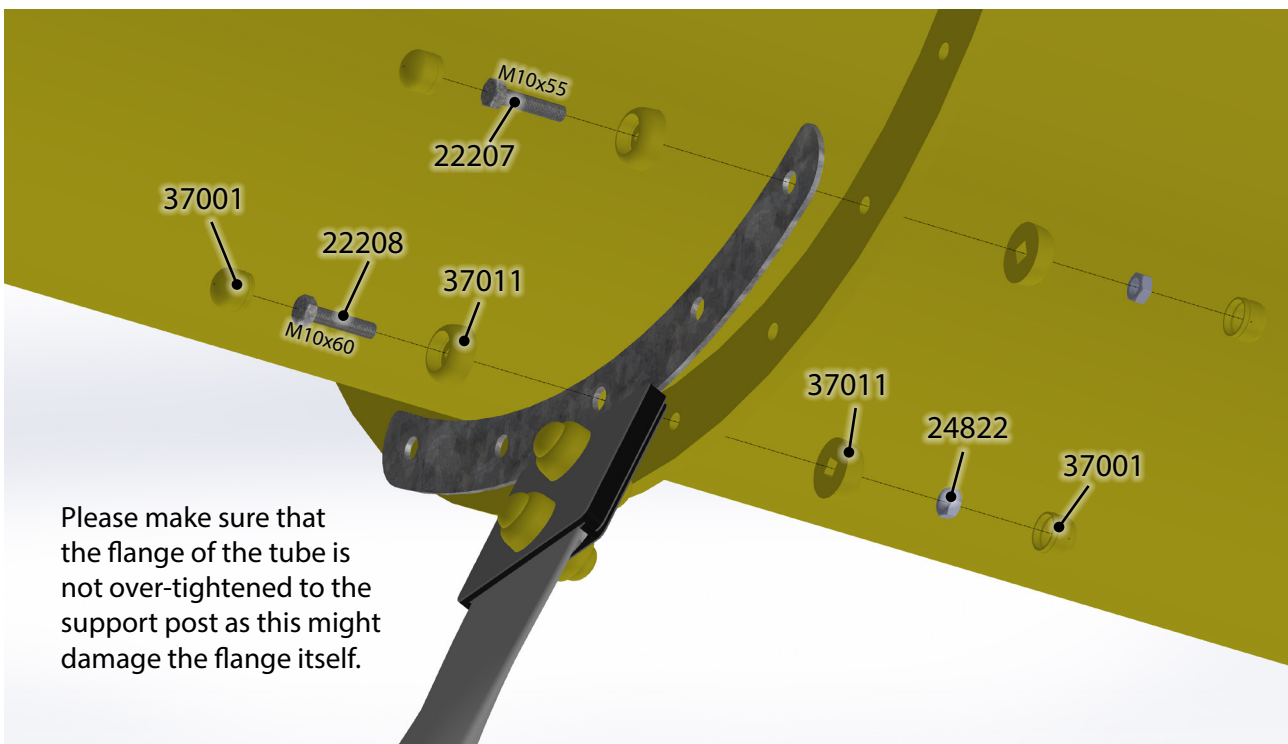

Installation of support posts for tube slide

Mount post sections

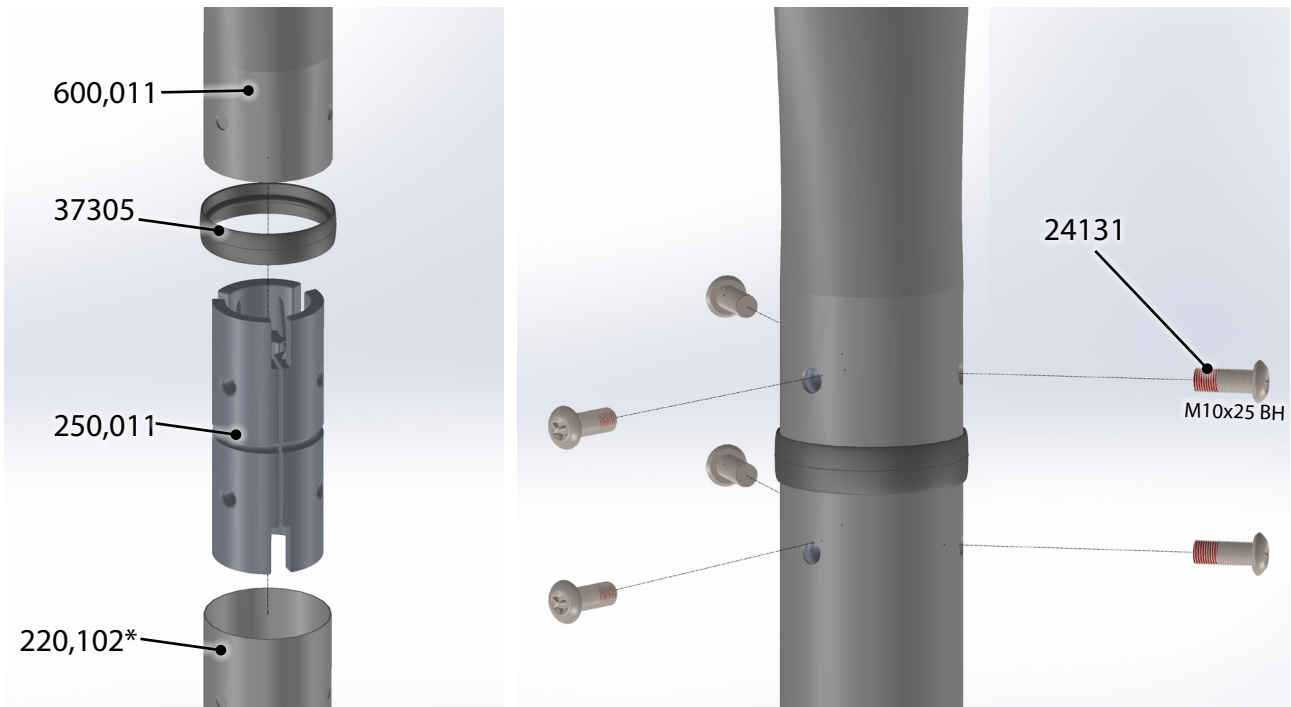

* Available in different heights

Adjust post length

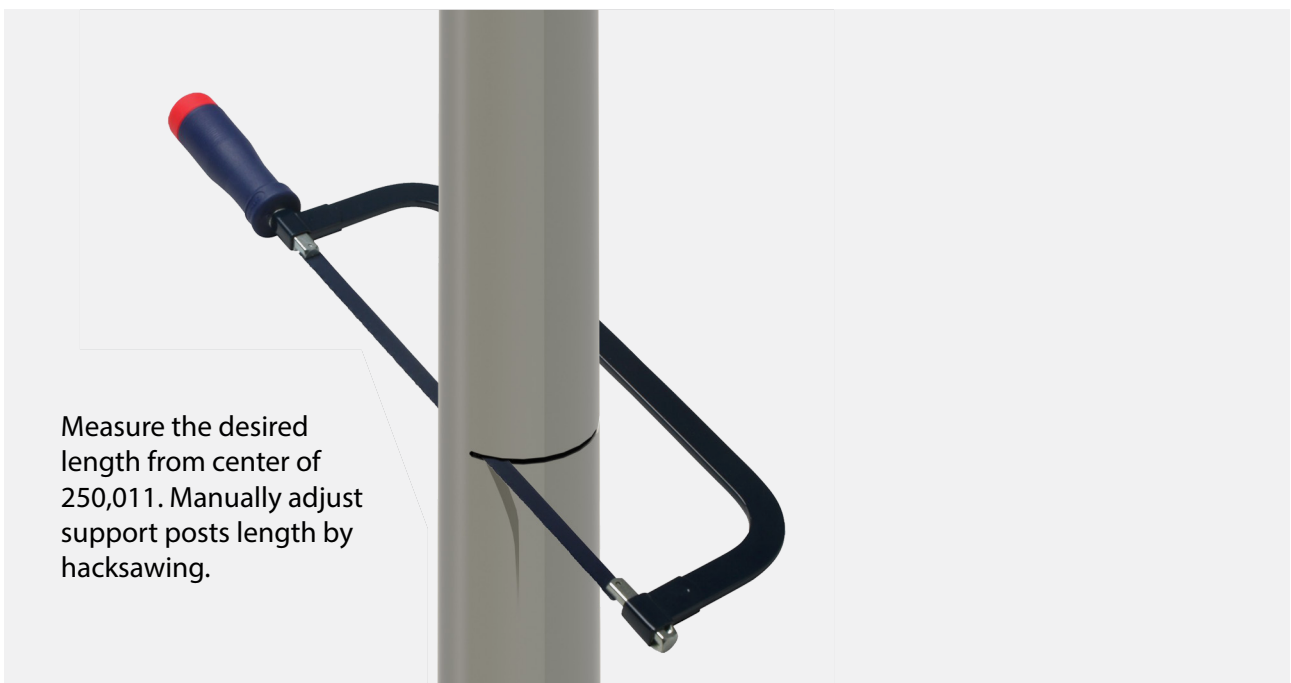

Installation of support posts for tube slide

Mount ground anchor to post

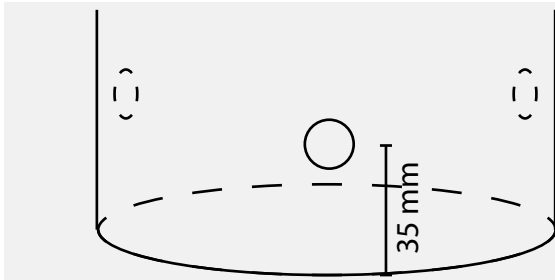

Manually drill 3 new holes for support post ground anchoring.

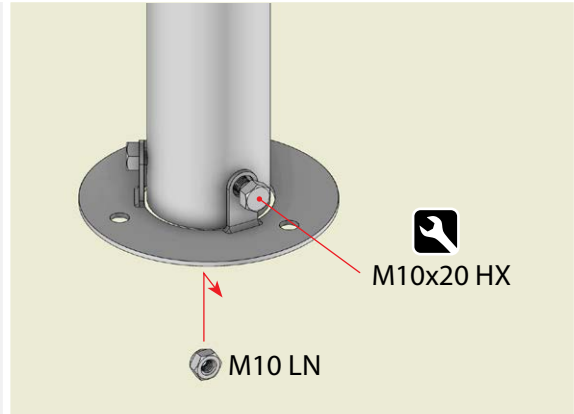

Mount posts to ground according to specifications

