

Tube slides

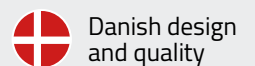

Embankment slides, Kildemosen daycare institution, Denmark

*Versatile and flexible
tube slides of very high quality*





“
*LEDON's tube slides
are very valued
all over the world* ♥



*Let your
imagination
run wild*



Suitable as escape chutes and emergency exits ▶

Applicable as crawling tubes ▼

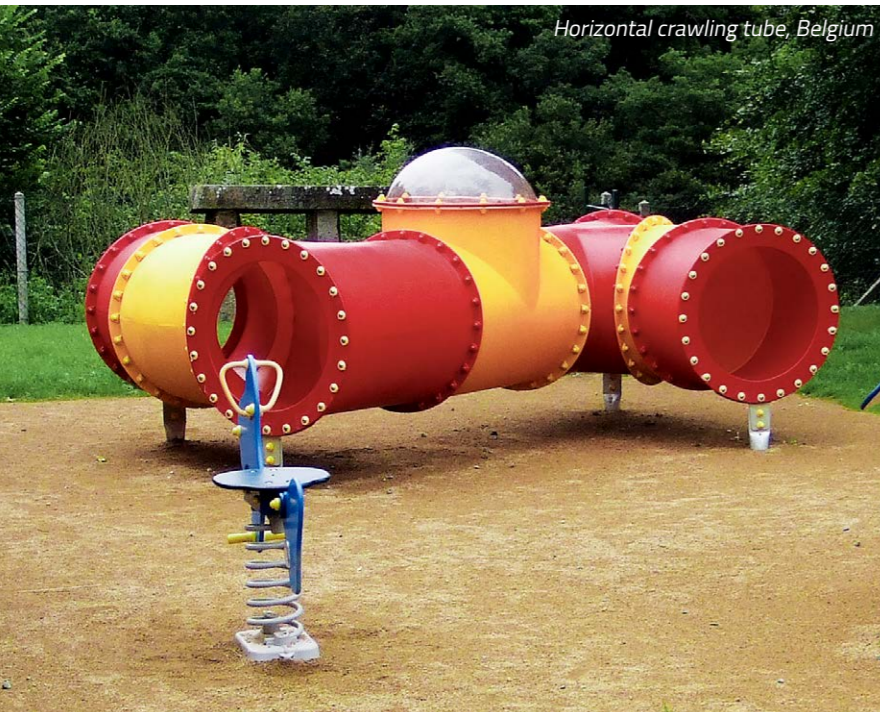

Horizontal crawling tube, Belgium



Escape chute, Germany



Public embankment slide, Denmark

Perfect as embankment slide ▶



Nature playground, Austria

Countless bespoke solutions

- 9 different tube elements in 5 colours offer many possible combinations.
- Sharp turns guarantee thrilling solutions on limited space.
- Bespoke solutions for all starting heights.
- Easy to add on to any play structure.
- Generally easy to fit into existing surroundings, thus allowing to re-use existing fall protection.

Upgrades any existing play structure ▲

Rotational moulding and laser measurements ensure precise tube elements that fit together every time



The dyes are lightfast, non-toxic and sustainable



Thoroughly tested quality

- Low static charge.
- Low-maintenance, non-toxic polyethylene (PE).
- UV protection, 5 years warranty on significant fading.
- Impact-resistant (-40 to +80°C).

Large stock of finished tube elements ensure fast delivery



Using modern robot technology ensures a consistent high quality

Indoor slides, RCN-de-Noordster, Holland
©IJREKA speeltoestellen



We help you design your new tube slide as many things have to be taken into consideration

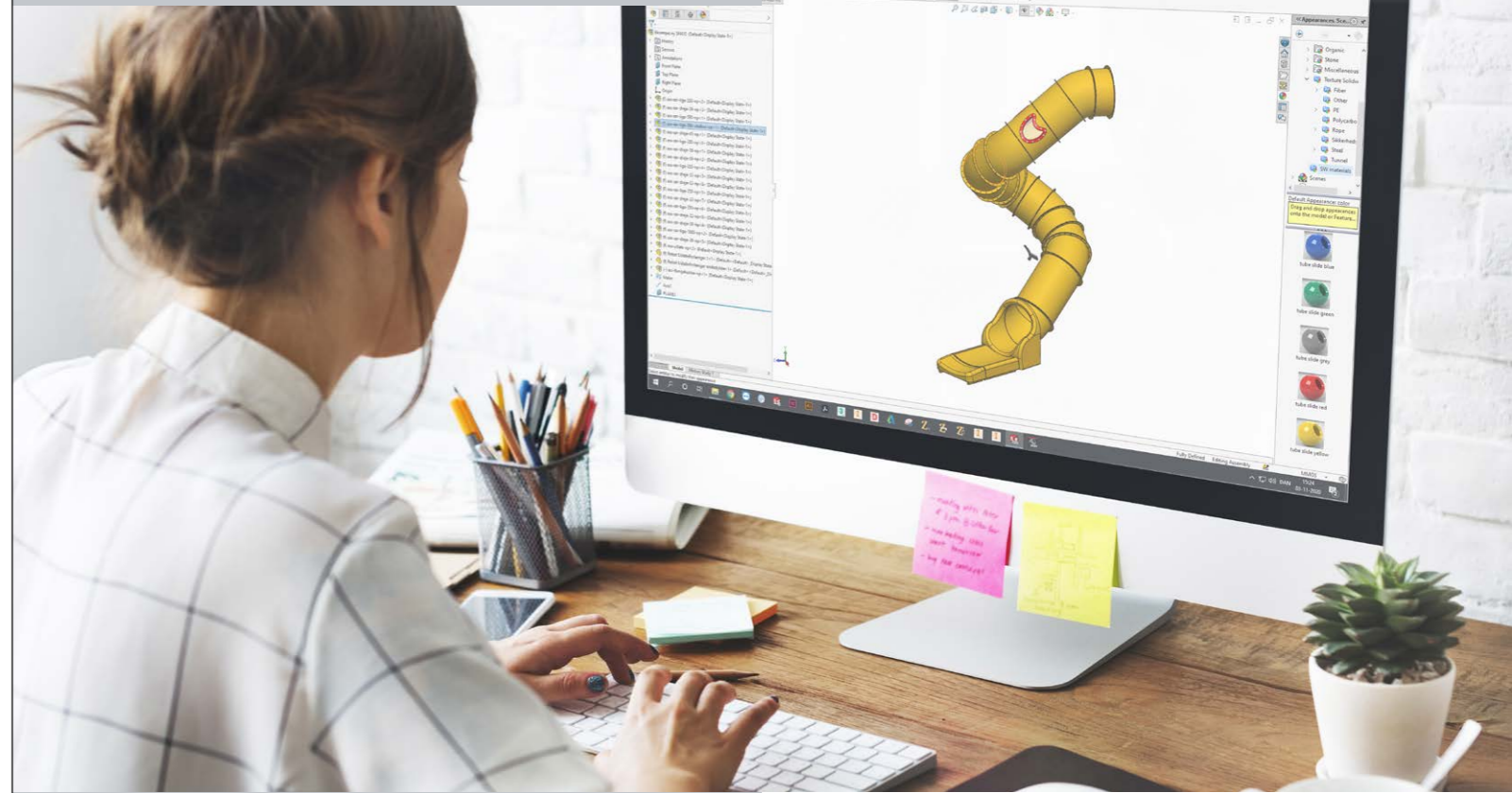

Tube slides from LEDON always come with detailed assembly instructions made especially for the ordered tube slide



Easy to design and mount

- Using LEDON's tube slide planner tool Tunnel Maker makes it possible to design custom-made tube slides for your project.
- Pre-drilled and numbered holes in the flanges.
- Detailed assembly instructions.

Various tube slides

Examples

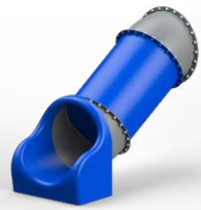

**Tube slide
TB6701**

Age: From 3 years
Fall height (H): 90 cm
Size: (LxWxH): 97 x 214 x 173 cm



**Tube slide
TB6703**

Age: From 3 years
Fall height (H): 175 cm
Size: (LxWxH): 187 x 219 x 258 cm



**Tube slide
TB6704**

Age: From 3 years
Fall height (H): 213 cm
Size: (LxWxH): 201 x 290 x 296 cm



Public playground, Australia

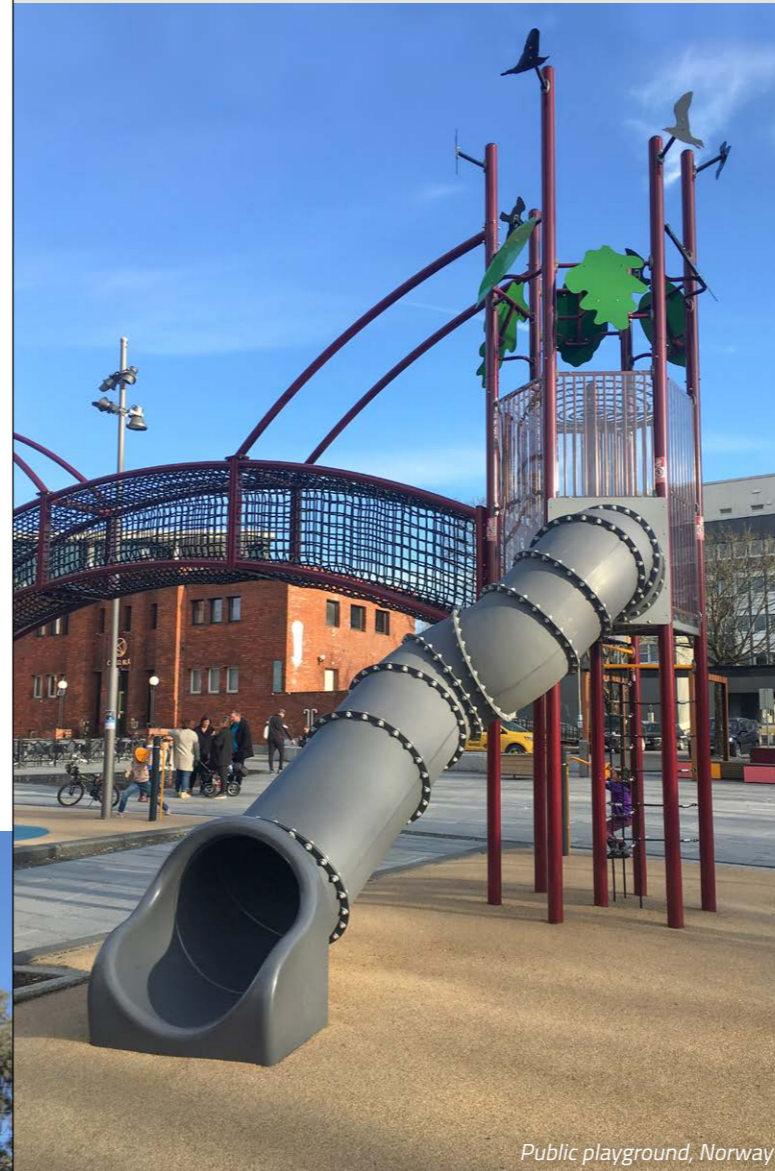

Public playground, Norway



Slide, RCN-de-Noordster, Holland
©IJREKA speeltoestellen



**Tube slide
TB6702**

Age: From 3 years
Fall height (H): 320 cm
Size: (LxWxH): 383 x 209 x 403 cm



**Tube slide
TB6705**

Age: From 3 years
Fall height (H): 305 cm
Size: (LxWxH): 187 x 386 x 388 cm

More examples



**Tube slide
TB6707**

Age: From 3 years
Fall height (H): 170 cm
Size: (LxWxH): 358 x 189 x 253 cm



**Tube slide
TB6708**

Age: From 3 years
Fall height (H): 310 cm
Size: (LxWxH): 284 x 435 x 393 cm



**Tube slide
TB6711**

Age: From 3 years
Fall height (H): 371 cm
Size: (LxWxH): 180 x 255 x 454 cm



**Tube slide
TB6706**

Age: From 3 years
Fall height (H): 400 cm
Size: (LxWxH): 202 x 857 x 483 cm



**Tube slide
TB6713**

Age: From 3 years
Fall height (H): 400 cm
Size: (LxWxH): 537 x 231 x 483 cm



Standard tube slides

Straight

**Start height 130 cm
TB6720**

Age: From 3 years
Fall height (H): 130 cm
Size (LxWxH): 97 x 245 x 213 cm



**Start height 235 cm
TB6724**

Age: From 3 years
Fall height (H): 235 cm
Size (LxWxH): 97 x 384 x 318 cm



**Start height 145 cm
TB6721**

Age: From 3 years
Fall height (H): 145 cm
Size (LxWxH): 97 x 264 x 228 cm



**Start height 260 cm
TB6725**

Age: From 3 years
Fall height (H): 260 cm
Size (LxWxH): 97 x 412 x 343 cm



**Start height 175 cm
TB6722**

Age: From 3 years
Fall height (H): 175 cm
Size (LxWxH): 97 x 301 x 258 cm



**Start height 275 cm
TB6726**

Age: From 3 years
Fall height (H): 275 cm
Size (LxWxH): 97 x 576 x 358 cm



**Start height 210 cm
TB6723**

Age: From 3 years
Fall height (H): 210 cm
Size (LxWxH): 97 x 347 x 293 cm



**Start height 300 cm
TB6727**

Age: From 3 years
Fall height (H): 300 cm
Size (LxWxH): 97 x 613 x 383 cm

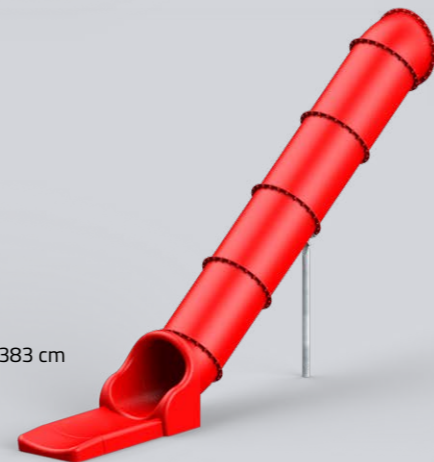

Choose any colour combination

LEDON's tube slides can be delivered in any colour combination you may want. See pages 16-17 for available colours.

360° spiral



**Start height 210 cm
TB6740**

Age: From 3 years
Fall height (H): 210 cm
Size (LxWxH): 185 x 219 x 293 cm

450° spiral

**Start height 240 cm
TB6730**

Age: From 3 years
Fall height (H): 240 cm
Size (LxWxH): 192 x 225 x 323 cm



**Start height 230 cm
TB6741**

Age: From 3 years
Fall height (H): 230 cm
Size (LxWxH): 186 x 249 x 313 cm



**Start height 270 cm
TB6731**

Age: From 3 years
Fall height (H): 270 cm
Size (LxWxH): 239 x 226 x 353 cm



**Start height 250 cm
TB6742**

Age: From 3 years
Fall height (H): 250 cm
Size (LxWxH): 188 x 222 x 333 cm

**Start height 300 cm
TB6732**

Age: From 3 years
Fall height (H): 300 cm
Size (LxWxH): 276 x 227 x 383 cm



**Start height 275 cm
TB6743**

Age: From 3 years
Fall height (H): 275 cm
Size (LxWxH): 191 x 261 x 358 cm



Tube components

Start panels



- Standard start panel**
 ● 2000,0772 ● 2000,0771 ● 2000,0773
 ● 2000,0775 ● 2000,0774



- Short arched start panel**
 ● 3000,056 ● 3000,055



- Long arched start panel**
 ● 3000,058 ● 3000,057

Straight sections



- Straight section, 35 cm**
 ● 6602,1 ● 6602,2 ● 6602,3 ● 6602,4 ● 6602,5

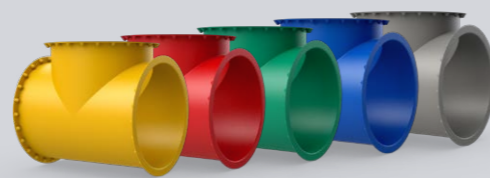

- T-piece section, 106 cm**
 ● 6608,1 ● 6608,2 ● 6608,3 ● 6608,4 ● 6608,5

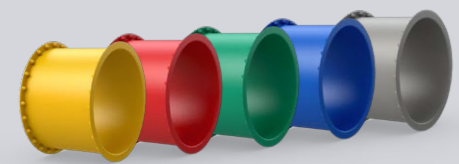

- Straight section, 59 cm**
 ● 6604,1 ● 6604,2 ● 6604,3 ● 6604,4 ● 6604,5

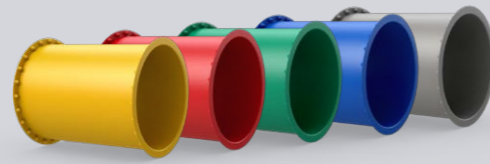

- Straight section, 106 cm**
 ● 6606,1 ● 6606,2 ● 6606,3 ● 6606,4 ● 6606,5



- Straight section with 2 windows, 59 cm**
 ● 6605,1 ● 6605,2 ● 6605,3 ● 6605,4 ● 6605,5
 Available window frame colors: ● ● ● ● ● ●

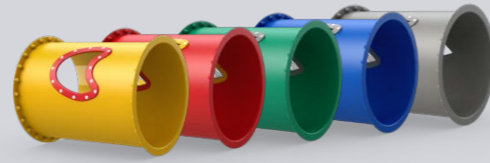

- Straight section with 2 windows, 106 cm**
 ● 6607,1 ● 6607,2 ● 6607,3 ● 6607,4 ● 6607,5
 Available window frame colors: ● ● ● ● ● ●



Bend sections



- Bend section, 32°**
 ● 6610,1 ● 6610,2 ● 6610,3 ● 6610,4 ● 6610,5



- Bend section, 38°**
 ● 6612,1 ● 6612,2 ● 6612,3 ● 6612,4 ● 6612,5



- Bend section, 45°**
 ● 6614,1 ● 6614,2 ● 6614,3 ● 6614,4 ● 6614,5

Exits



- Exit section**
In-ground mounting:
 ● 6616,1 ● 6616,2 ● 6616,3 ● 6616,4 ● 6616,5
Surface mounting:
 ● 6618,1 ● 6618,2 ● 6618,3 ● 6618,4 ● 6618,5

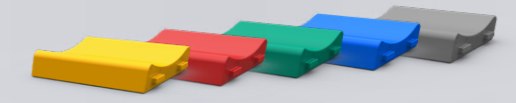

- Extension for exit section, intermediate piece**
In-ground mounting:
 ● 6636,1 ● 6636,2 ● 6636,3 ● 6636,4 ● 6636,5
Surface mounting:
 ● 6646,1 ● 6646,2 ● 6646,3 ● 6646,4 ● 6646,5

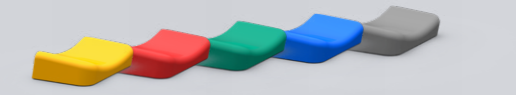

- Extension for exit section, end piece**
In-ground mounting:
 ● 6637,1 ● 6637,2 ● 6637,3 ● 6637,4 ● 6637,5
Surface mounting:
 ● 6647,1 ● 6647,2 ● 6647,3 ● 6647,4 ● 6647,5



**New flexible
exit extension**

Whether an exit extension is required depends on several factors such as height, length, speed and inclination. We have therefore developed a new modular exit extension to ensure a safe exit from all types of tube slides.

See further specifications on page 20.

NEW

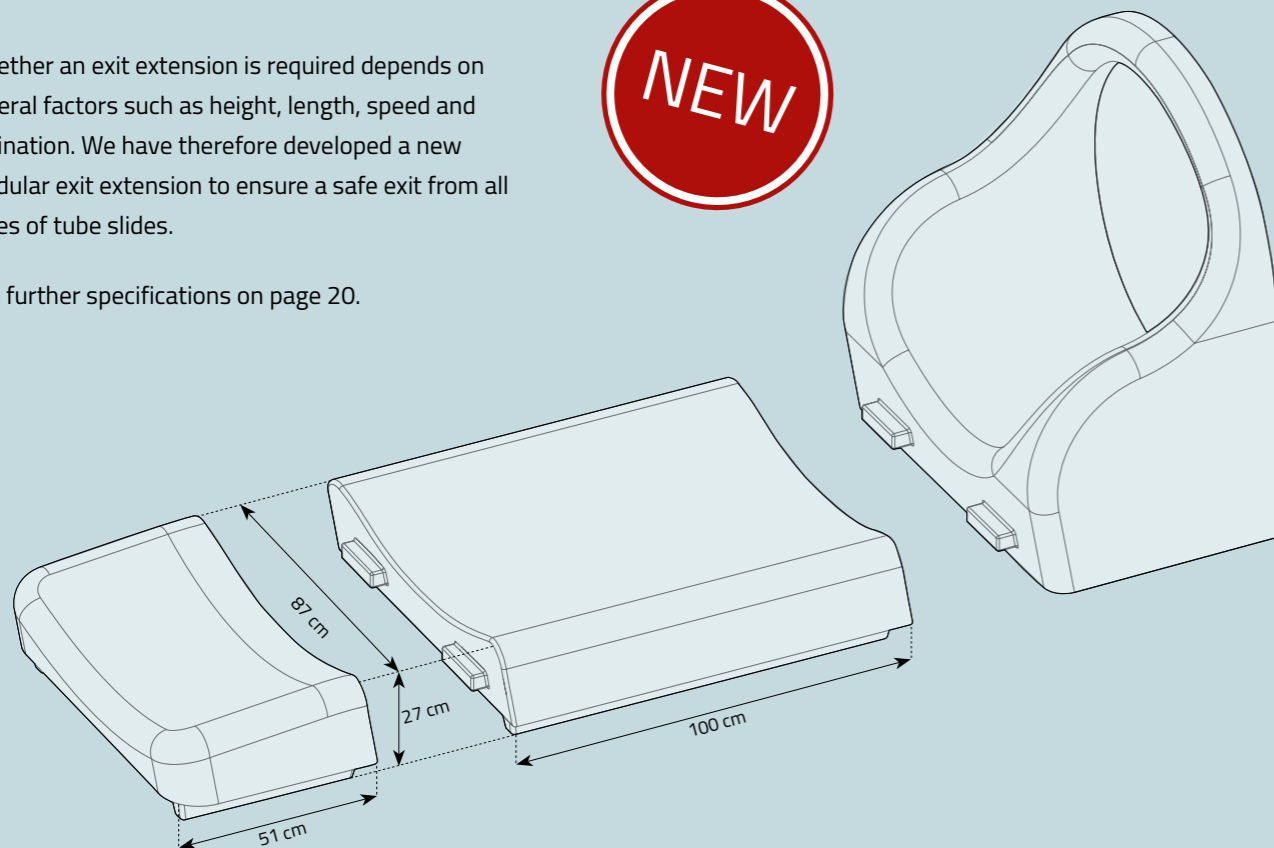

Tube components

Accessories



Dome
● 4000,103



Anti-climb panel
● In-ground mounting: 6600,25G
● Surface mounting: 6600,25C

LEDON's tube slides are easily mounted onto hard surfaces.

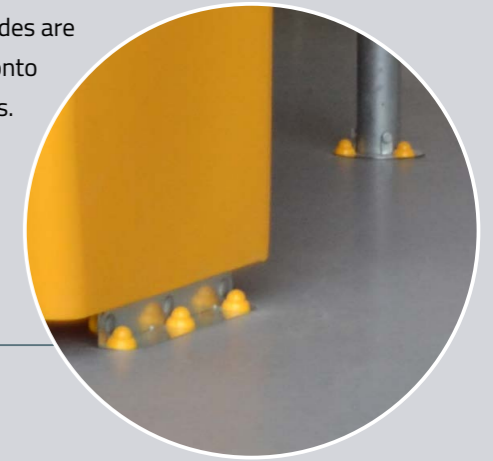

Mountings

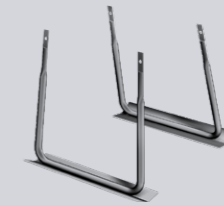

Ground anchor
Item no. cf. exit section



Concrete fitting
Item no. cf. exit section

Poles and supports



Support post



Support post, two-legged



Intermediate support

Available in many different heights and angles



Questions?

Should you have any questions, or should you need help, you are welcome to contact us on

+45 7482 6565 or info@ledonplay.com



All LEDON's tube slide components are designed without sharp edges.

Technical specifications

Start panels and anti-climb panels

Material

- 15 mm non-toxic polyethylene approved in accordance with IAW EN 1171, part 1-3.

Material properties

- Low maintenance.
- UV-protected colours and raw material.
- Free from heavy substances like chrome, lead etc.
- 20 years warranty on LEDON's PE boards.

Support posts

Material

- Hot-dipped galvanised steel.
- Diameter: 76 mm. thickness: 2 mm.

Material properties

- Surface treatment to avoid corrosion.
- Low maintenance.
- 20 years warranty on support posts.

Exit extensions

Material

- Up to 9 mm polyethylene (PE).

Colours

- Red, yellow, green, blue and grey.

Material properties

- Same properties as tube components.

Ground anchor

Material

- Hot-dipped galvanised steel.

Material properties

- Low maintenance.
- Available for in-ground and surface mounting.

Windows and domes

Material

- Frame: 15 mm polyethylene (PE).
- Pane: 3 mm impact-resistant polycarbonate.

Frame colours

- Red, yellow, green, blue, grey and black.

Types

- Windows are available for 59 cm and 106 cm straight tube sections only.

Material properties

- The dome is made of polycarbonate with an incredibly high impact resistance within -40°C to +120°C – the dome is practically impossible to break.
- Does not change colour caused by the weather and is free from heavy substances.
- The window frame is made of low-maintenance polyethylene (PE plastics).

Tube components

Material

- Up to 9 mm polyethylene (PE).

Colours

- Red, yellow, green, blue and grey.

Types

- Straight tubes: 35, 59 and 106 cm.
- Bend sections: 32°, 38° og 45°.
- Exit sections and T-pieces.

Material properties

- Very hardy.
- Hardly heats up in the sun.
- No glare due to the matte finish.
- Partly translucent.
- UV-protected colours and raw material.
- 5 years warranty on significant fading.
- Impact-resistant (-40°C to +80°C).
- Easy to clean, graffiti-safe.
- Only little reverberation in windy weather and during wild play.

Technical drawing

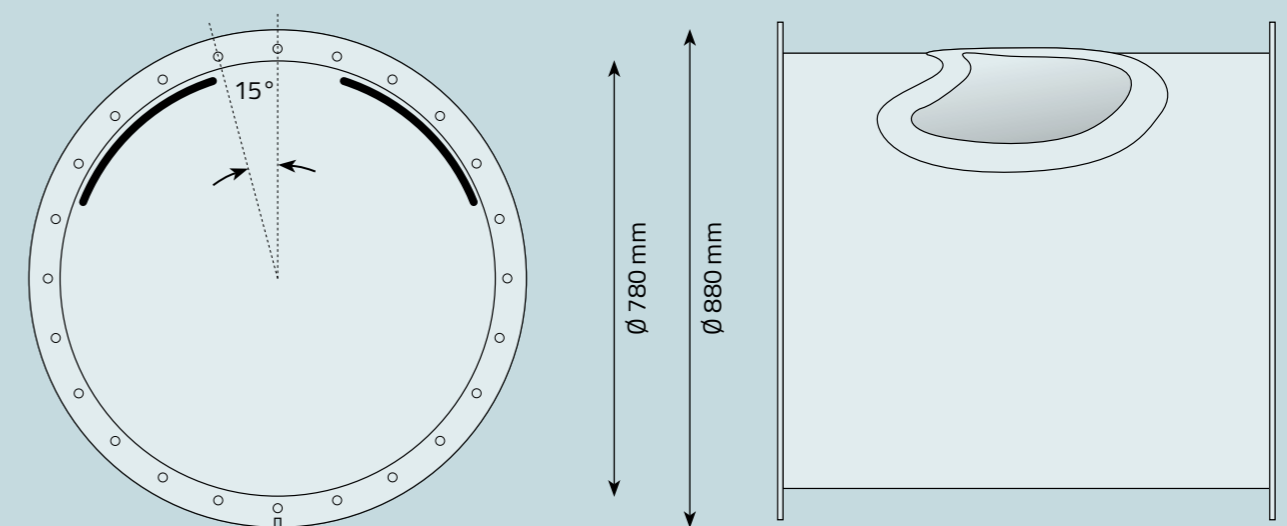

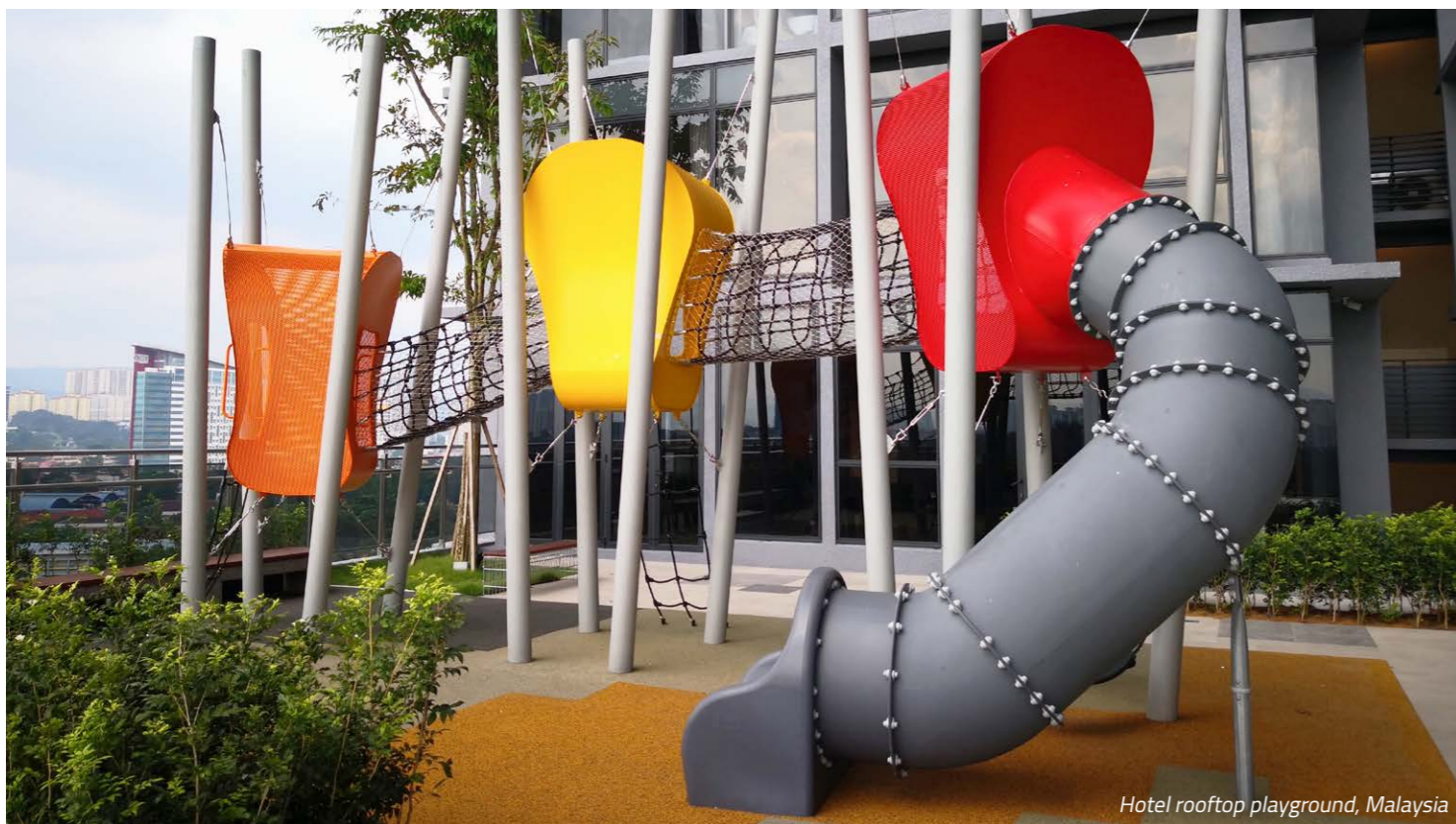

Hotel rooftop playground, Malaysia



Kindergarten, Norway



Public playground, Switzerland

Warranties & certificates



20 years warranty

- HDPE panel parts
- Steel posts and top beams
- Steel floor beams and frames
- Other galvanised structural parts
- Stainless steel components

5 years warranty

- Painted metal parts
- Springs
- Ropes and nets
- Transparent polycarbonate domes and windows
- Rotation-moulded PE tube slide tubes

10 years warranty

- Other galvanised fittings
- Injection-moulded components
PE and PA6 components

2 years warranty

- Movable metal and plastic parts



All products approved according to EN1176

Safety is a priority at LEDON, and that is why our tube slides of course are controlled and approved in accordance with European Standard EN1176.

All certification is executed by TÜV. Only products living up to the strict requirements for safety, reliability and quality pass the test.



Sales, marketing and product development:

Nordkajen 21, DK-6000 Kolding

Production and administration:

Vestergade 25, DK-6510 Gram

Phone: +45 7482 6565

E-mail: info@ledonplay.com

Homepage: www.ledonplay.com

*All information subject to misprint
and product changes.*

*All graphical material are protected
by copyright and must not be used
without LEDON A/S' permission.*