











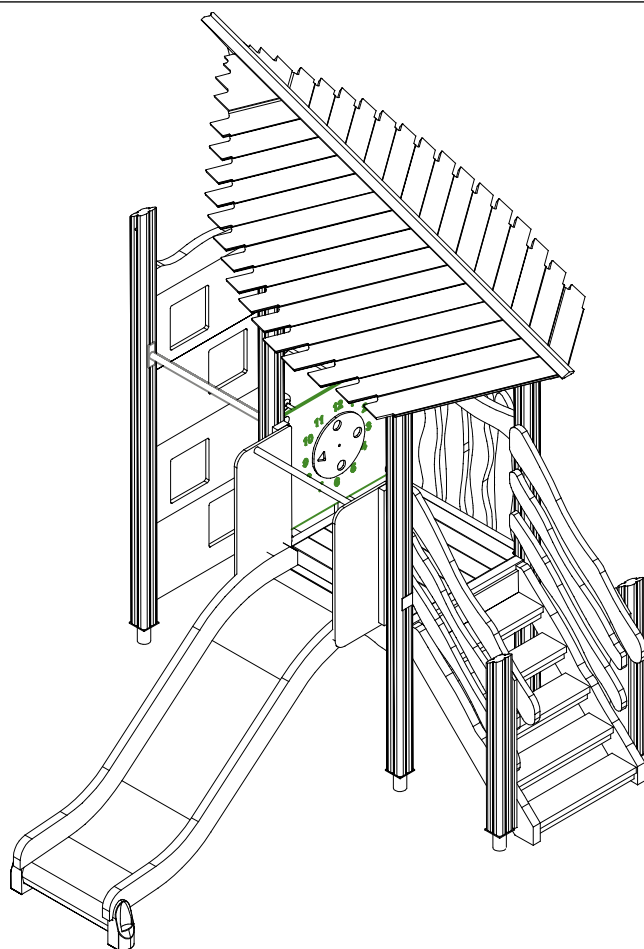



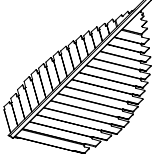
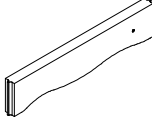
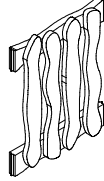
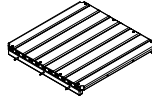



FLORA

ASENNUSOHJE
MONTERINGSANSVISNING
INSTALLATION INSTRUCTION
AUFBAUANLEITUNG
NOTICE D'INSTALLATION

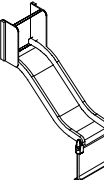
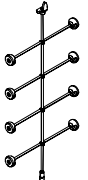
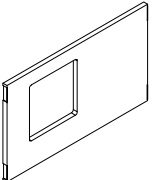
DATE: 29.9.2025

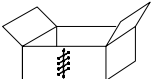
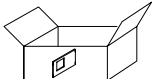
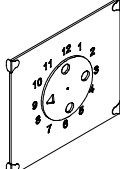
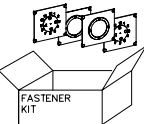
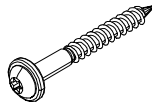
QFL0264-2

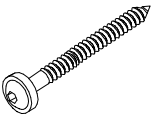
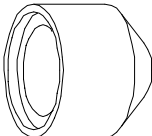
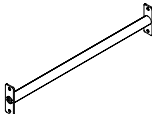
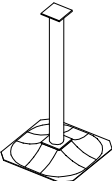
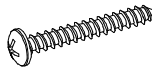

702286	PCS	705203-614	PCS	705211-614	PCS	705230-614	PCS	705258-614	PCS	706178-614	PCS
	1		1		5		1		1		4
65x65				45x145x724						93x93x2246	
706180-614	PCS	706185-614	PCS	706192-614	PCS	706234-614	PCS	706480-303	PCS	706540-707	PCS
	2		1		2		1		1		4
93x93x2538				93x93x946				1580x705		20x702x415	
706543	PCS	706557	PCS	706772-707	PCS	706778	PCS	900240	PCS	901902	PCS
	1		4		1		1		4		2
								Ø8x70		30.7x60.9x100	
903093	PCS	905104	PCS	907694-216	PCS	909521	PCS	980114	PCS		PCS
	20		32		2		8		4		
Ø8x90		M10		L 704				Ø4x20			
	PCS		PCS		PCS		PCS		PCS		PCS
	PCS		PCS		PCS		PCS		PCS		PCS
	PCS		PCS		PCS		PCS		PCS		PCS

- EN/AS Impact Area 24.2 m²
- - - Falling Space 26.3 m²
- Max Falling Height 2040 mm

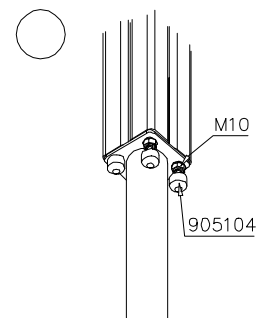
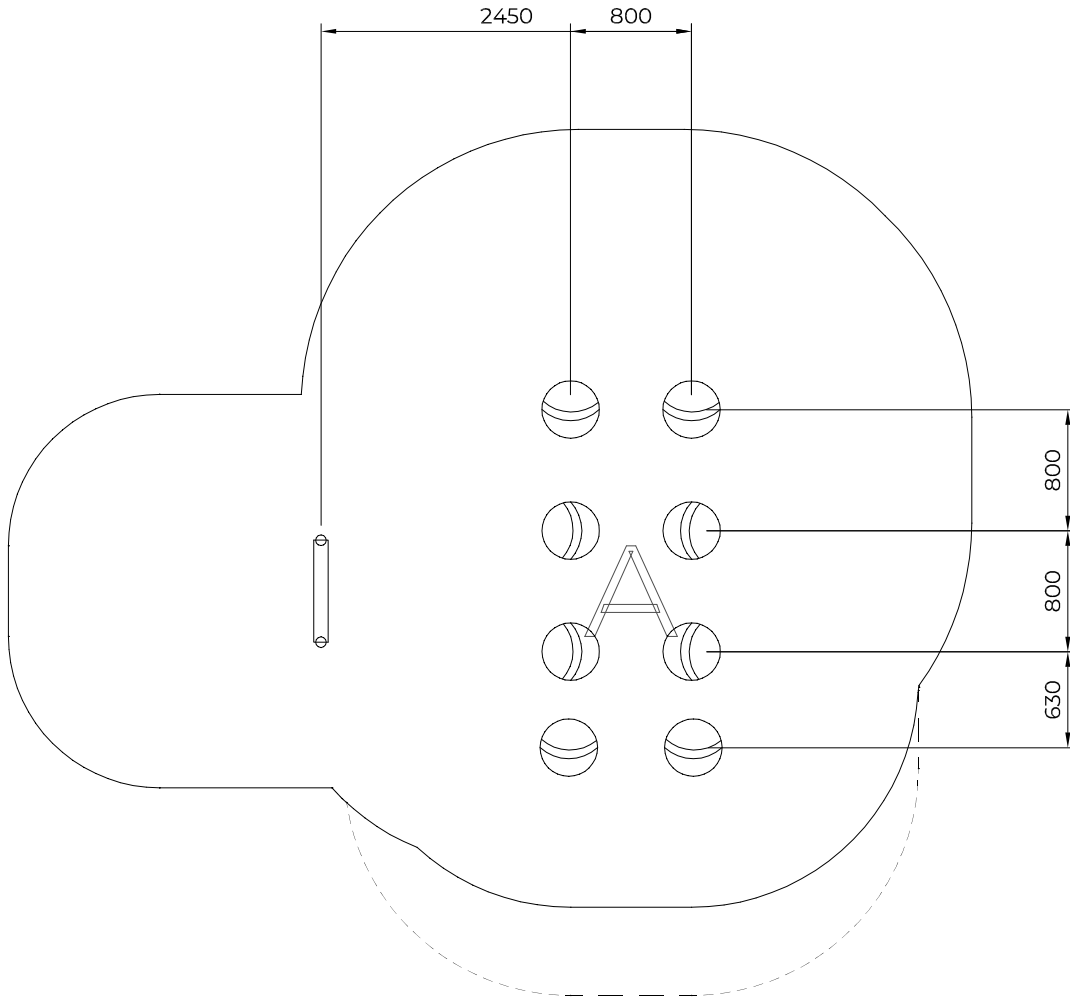

- EN/AS Impact Area 24.2 m²
- - - Falling Space 26.3 m²
- Max Falling Height 2040 mm

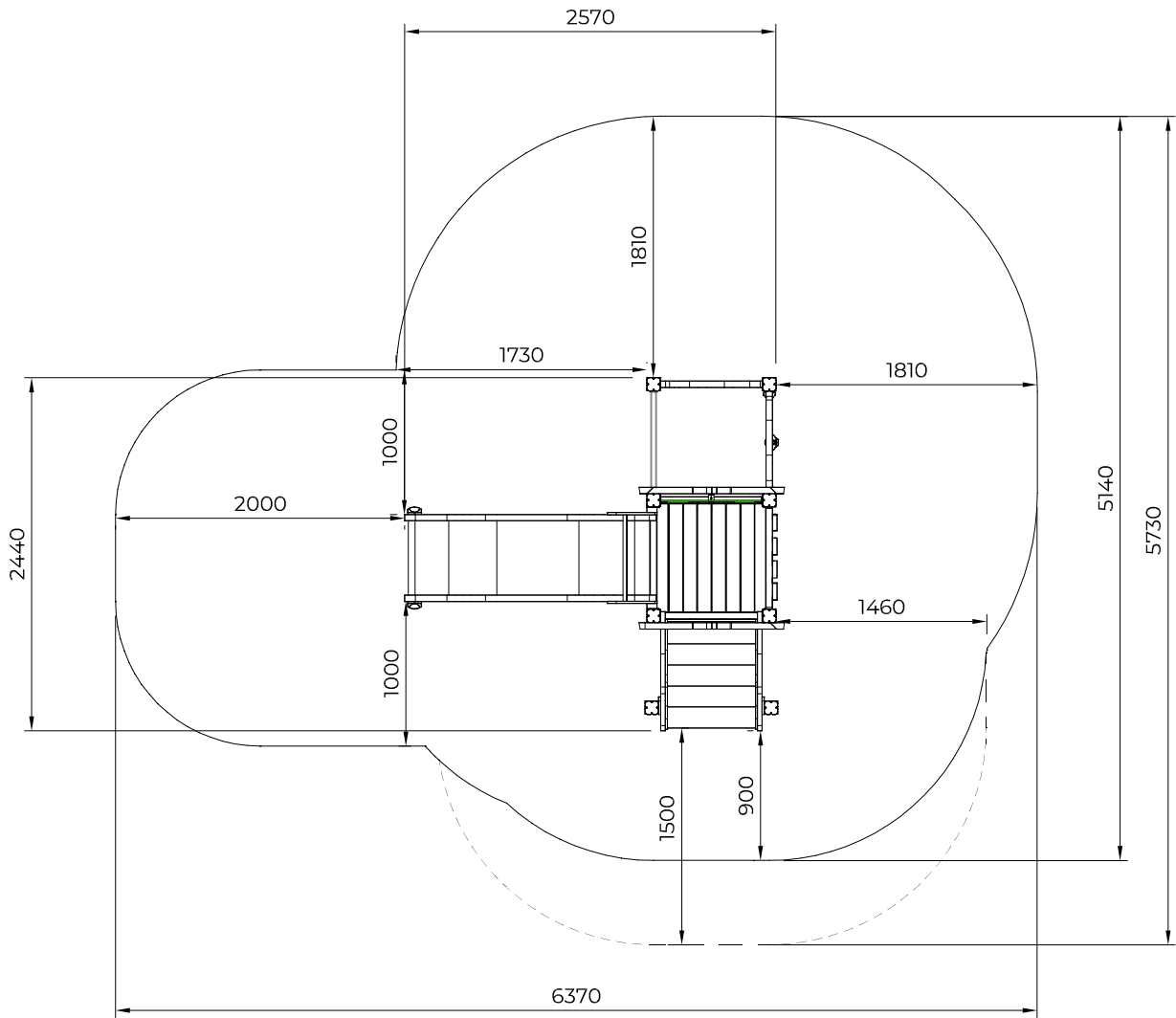

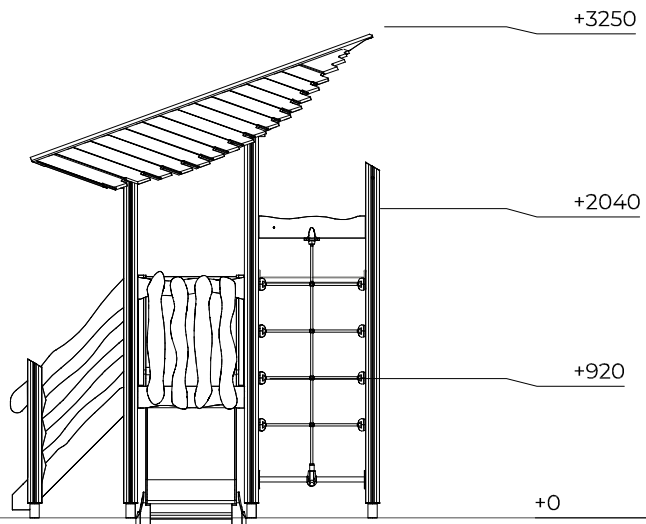
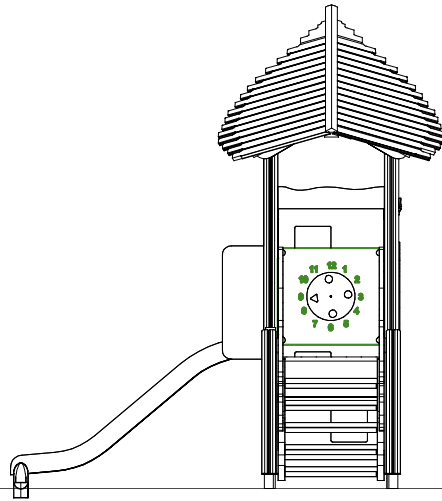

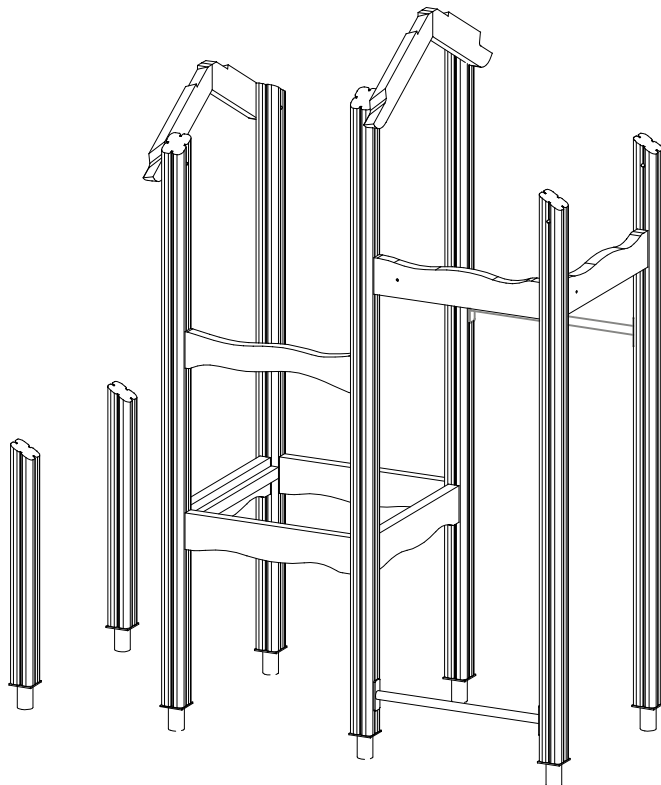
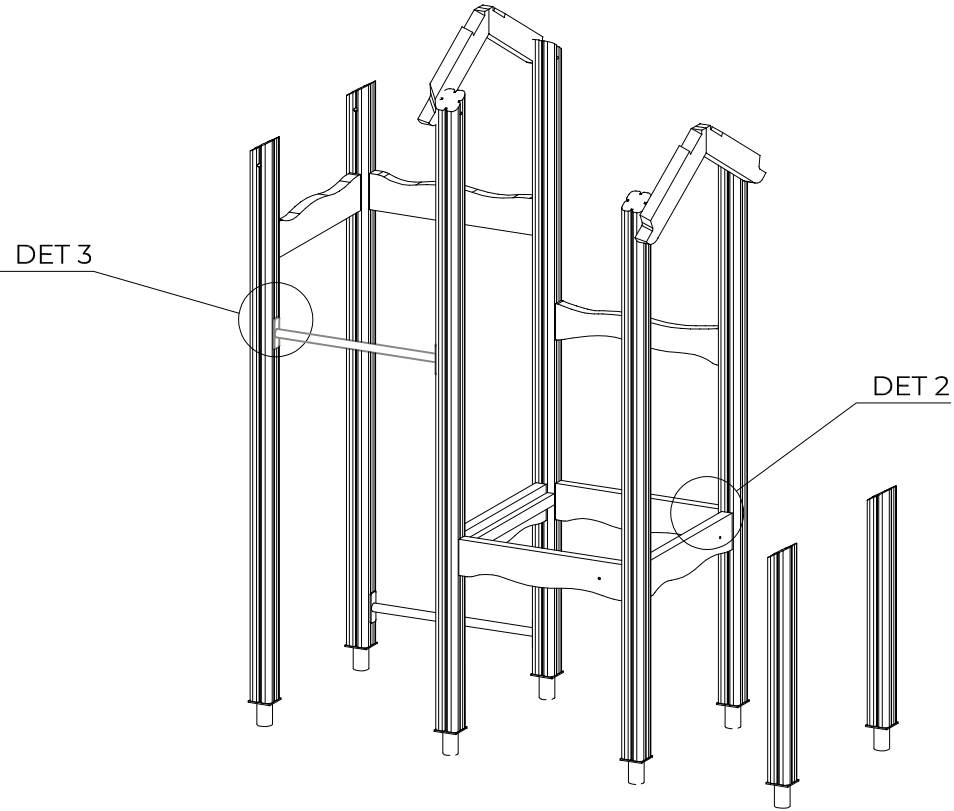

DET 1

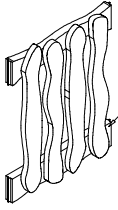

NOTE:
Walls contain
floor beam 705211.
HUOM:
Seinät sisältävät
lattia puomin 705211.

DET 2

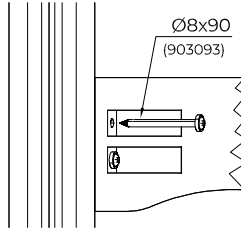

DET 3

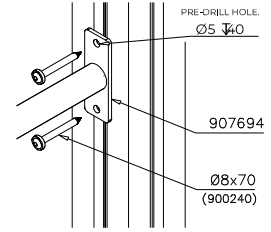

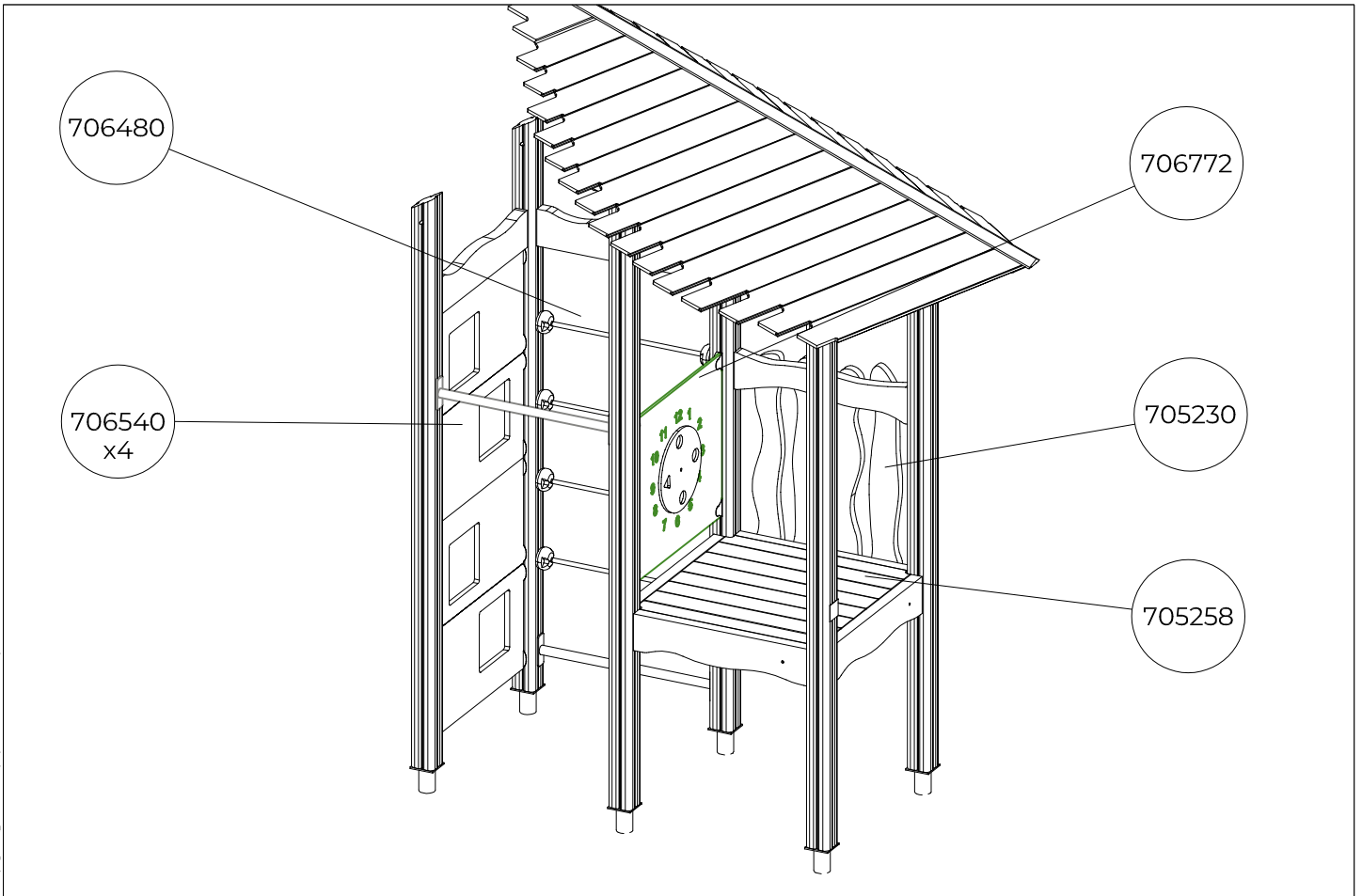
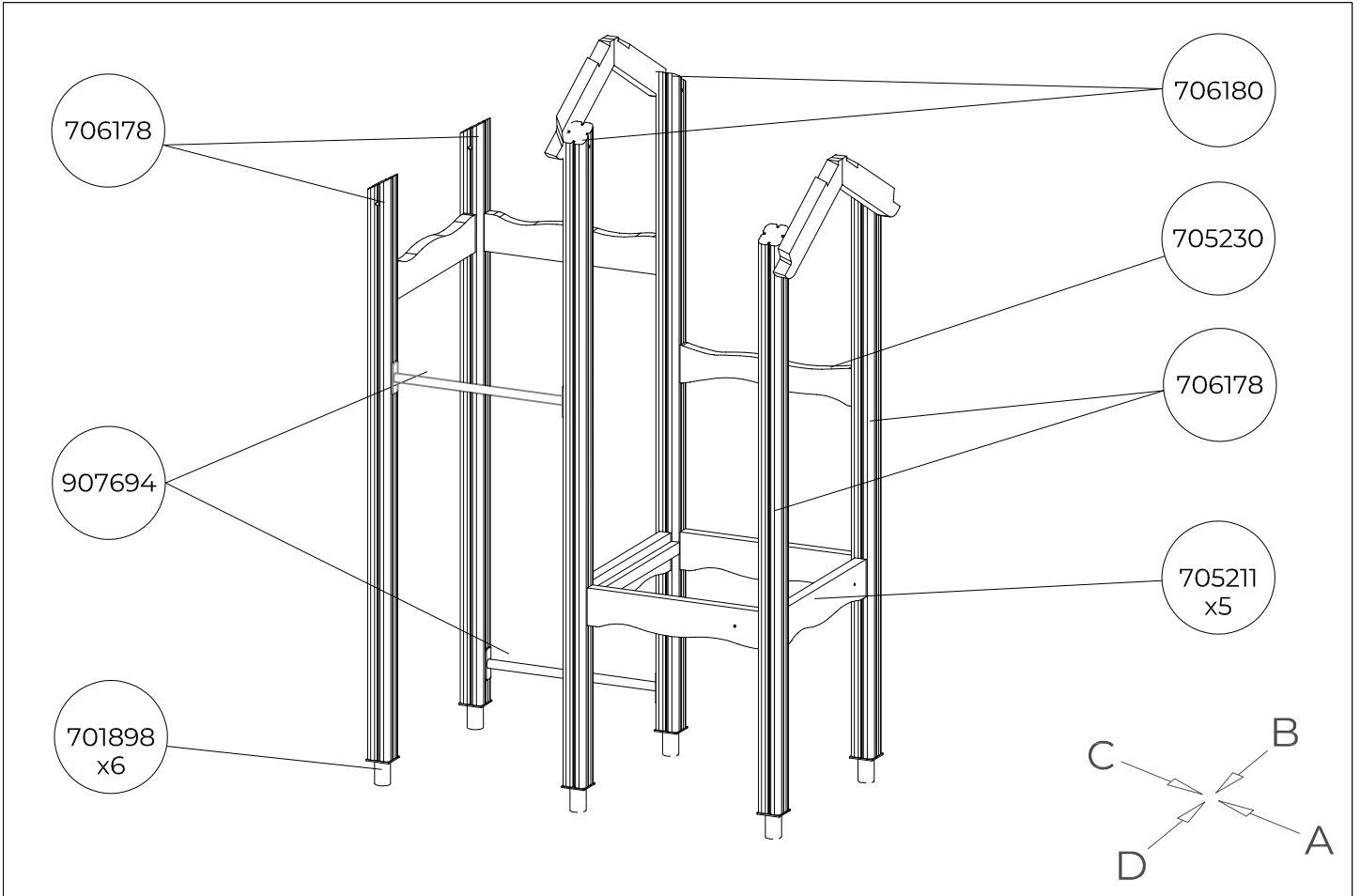

(A)

1:50

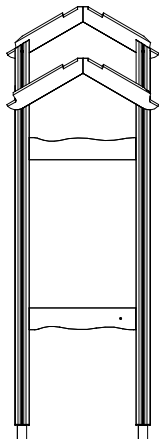

(B)

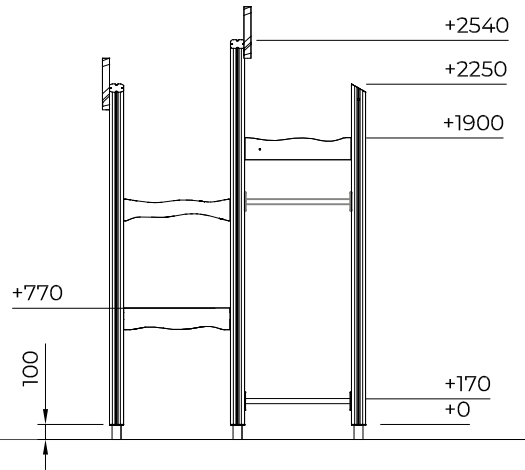

(C)

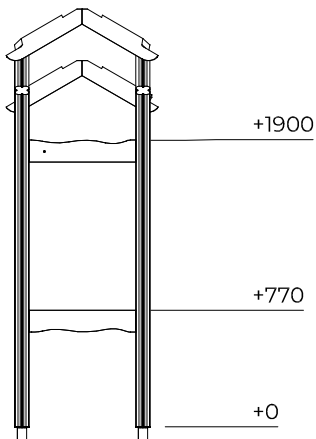

(D)

