

# Installation Instructions

## Ground Fixed

Freechimes  
Alto/ Soprano  
Page 1 of 4



**1. Carefully lay 2 x legs on a level surface** and check distance between **legs is equal**. Line up pre drilled holes in the backboards with the holes in legs and ensure the instrument is aligned square with the legs. **Fix in place using M8x40mm screws** supplied (see installation guide)

**2. Attach Ground Fixings** to base of legs (**See Ground Fix Post Installation Sheet**)

**3. Excavate 2 holes** on site of installation minimum **500mm deep** ( adjust depth according to age range for intended players)

**4. Carefully raise the instrument** from the ground **with legs attached** and locate (lower) legs **into holes** making sure they are vertical and level prior to concreting in place. (See Ground Fix Sheet)

**5. Once happy with location and levels, fill holes using rapid hardening concrete.** Be sure to compact concrete around legs and leave to dry according to manufactures guidelines

**6. Beaters can be fixed to Steel posts with fixings provided**

Install Instrument with 1.5m free space (from widest point) around it.

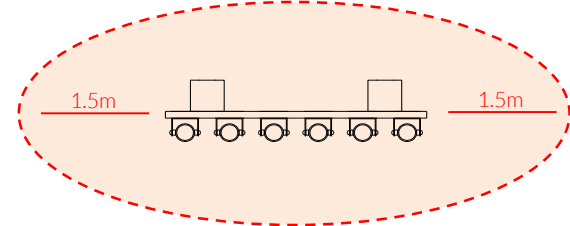

Metric Conversion:  
500mm/ 1 ft 7<sup>11</sup>/<sub>16</sub>"  
900mm/ 2 ft 11<sup>7</sup>/<sub>16</sub>"  
1100mm/ 3 ft 7<sup>5</sup>/<sub>16</sub>"  
1.5m/ 59"

Weight of heaviest part **8.35kg** (Freechimes)

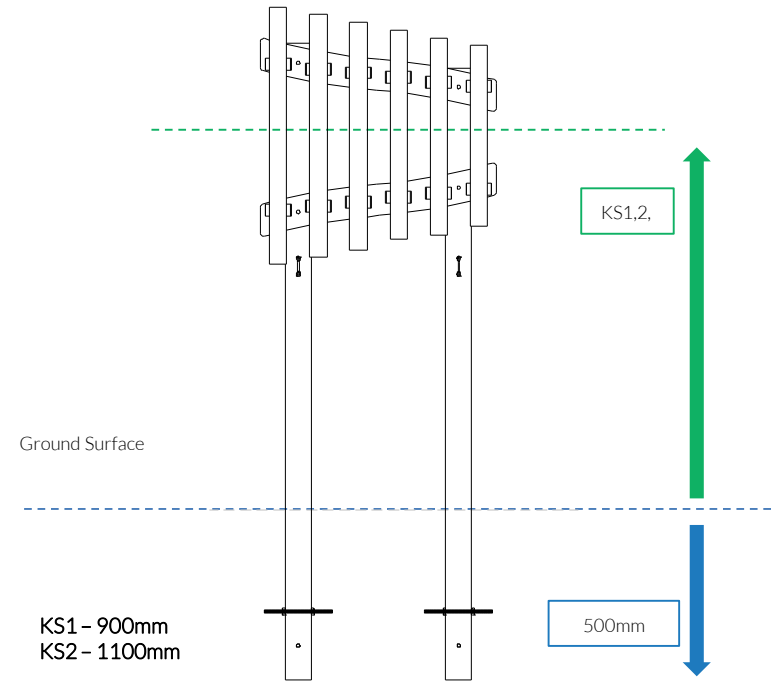

### Components:



Pair Small  
Beaters X1

Ground Fix  
Components:





x4  
M10x200 Threaded Bar



x8  
M10 Nut

# Assembly Guide PPFREC

**Tools:**

 x1  
 x1  

TX 30 Driver Bit    TX 40 Driver Bit

## Ground Fixed



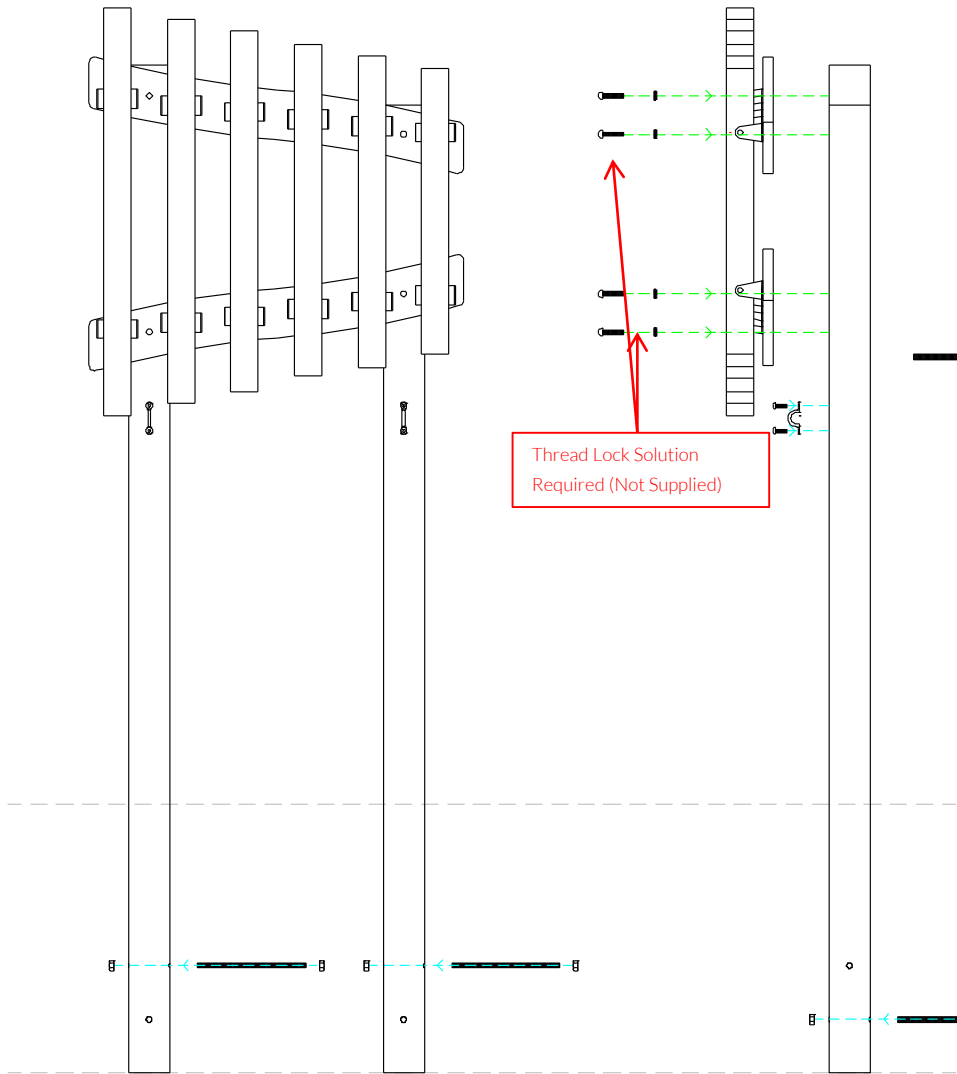



Freechimes  
Alto/ Soprano  
Page 2 of 4



Thread Lock Solution  
Required (Not Supplied)

Thread Lock Solution  
Required (Not Supplied)

**COMPONENTS LIST:**

-  M10 Nut X8
-  M10x200 Threaded Bar X4
-  Saddle Strap X2
-  M6x20 Pin torx X4
-  M8 Lock washer X4
-  M8x40 Pin torx X4

**Components:**

Pair Small Beaters X1

Ground Fix Components:

 x4  
 x8

Spares available from  
[percussionplay.com](http://percussionplay.com) or from your  
local distributor

16 Kg

# Ground Fix Post Installation

Foundations should not present a hazard. These foundations are recommended as a guide, for more information on foundation details for various surface see Part 7 of BS EN 1176.

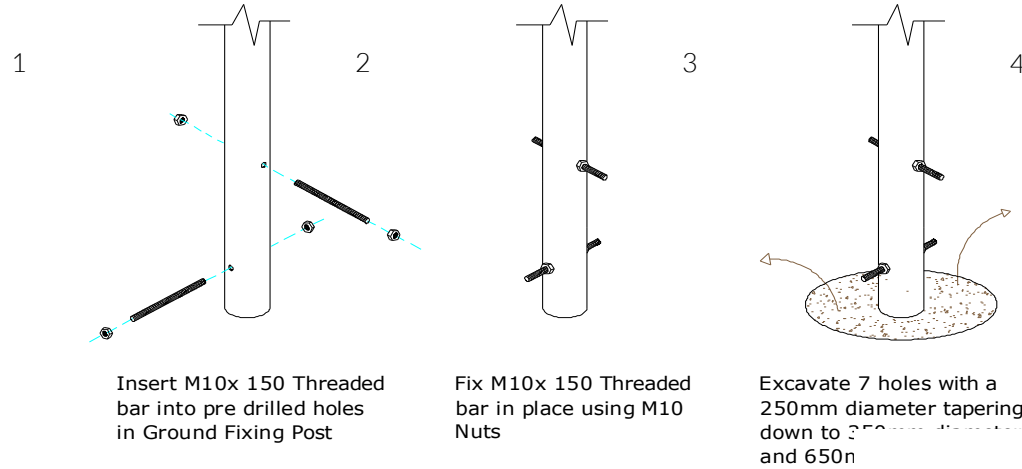

Metric Conversion:	
50mm	2"
100mm	4"
250mm	10"
350mm	14"
500mm	1 ft 7 11/16"
550mm	1 ft 9 21/32"
	"

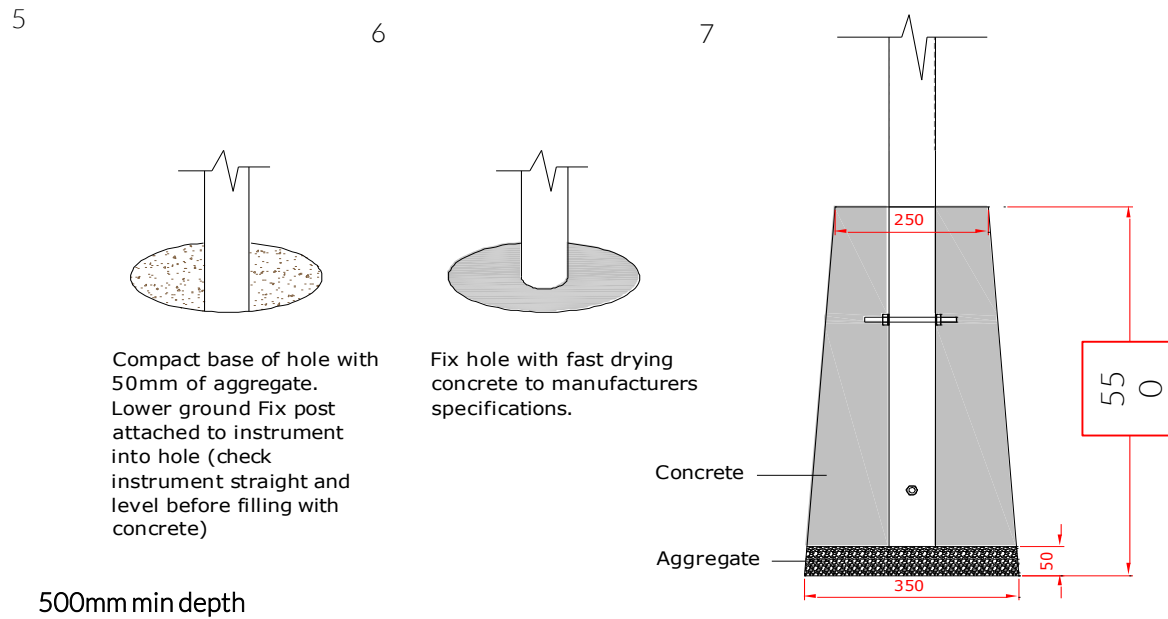

500mm min depth

## Ground Fixed

Freechimes  
Alto/ Soprano  
Page 3 of 4



## Components:



x4

M10x200 Threaded Bar



x8

M10 BZP Nut

Thread Lock Solution  
Required (Not Supplied)



MADE IN BRITAIN

BS EN 1176

Foundations should not present a hazard. These foundations are recommended as a guide, for more information on foundation details for various surface see Part 7 of BS EN 1176.

## Ground Fixed

Freechimes  
Alto/ Soprano  
Page 4 of 4



1

Carefully lay 2 x legs on a level surface. Line up pre drilled holes in the backboards with the legs and ensure the instrument is aligned square with the legs. Fix in place using 8x70mm screws supplied

Metric Conversion:  
50mm/ 2"  
250mm/ 10"  
350mm/ 14"  
500mm/ 1 ft 7 11/16"  
472mm/ 1 ft 6 37/64"  
709mm/ 2 ft 3 29/32"

709mm Diatonic Post Centres  
472mm Pentatonic Post Centres

2

Excavate 2 holes with a 250mm diameter tapering down to 350mm diameter and minimum 650mm depth

3

Compact base of hole with 50mm of aggregate. Lower ground Fix posts attached to instrument into hole (check instrument straight and level, and at correct height before filling with concrete)

4

Fill holes with fast drying concrete to manufacturers specifications. If posts protrude above instrument they can be cut down

Minimum installation depth required 650mm, to set height of instrument bury deeper until optimum playing height is achieved.

# Installation Instructions

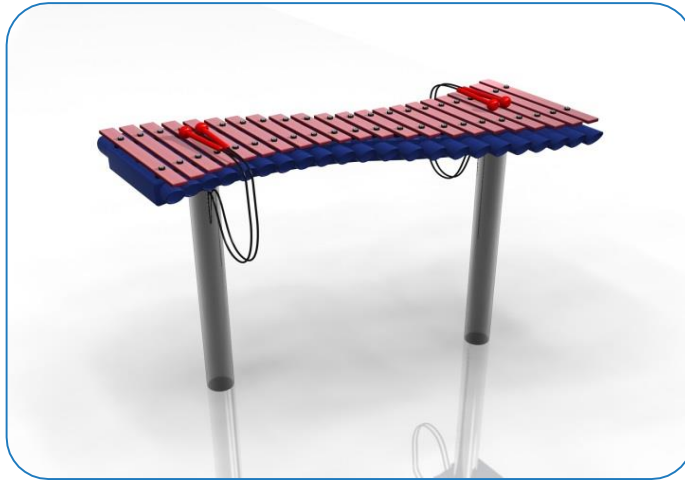

1. Attach the steel legs to the base of the instrument with the M8 Nyloc Nuts and 2 part security caps. (1.1) (See Assembly Guide)

2. Attach Ground Fixing posts to legs (1.2) (See Ground Fix Post Installation Sheet)

3. Excavate 2 holes for the Steel legs 250mm diameter by 400-550mm deep depending on Key stage, in desired location upon decision from customer.

4. Locate (lower) legs into holes making sure they are vertical and level prior to concreting in place.

5. Once happy with location of the Instrument, fill holes using rapid hardening concrete. Be sure to compact concrete around legs and leave to dry according to manufactures guidelines.

6. Attach the 1 pair of beater to the saddle strap on the leg. (1.3)

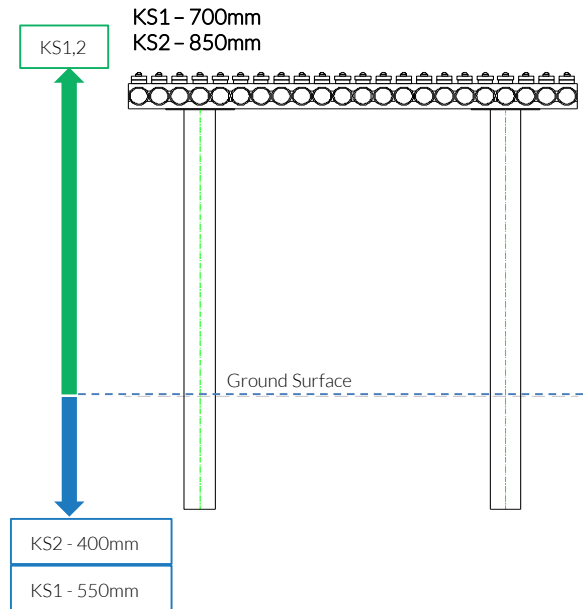
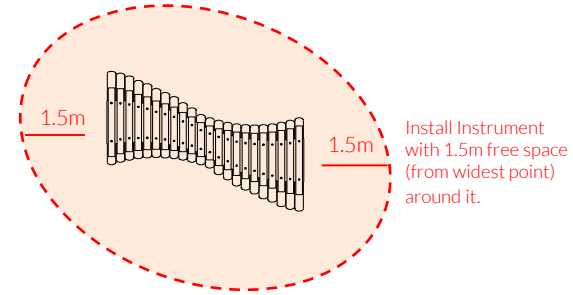

Weight of heaviest part 14kg (Duo)

## Ground Fixed

Duo  
Page 1 of 3



### Instrument Components:

-  x8  
M8 Nyloc Nut
-  x4  
M6x20 Security Screw
-  x8  
2 Part Cover Cap
-  x2  
M6 Saddle Strap

Metric Conversion:  
250mm/ 10"  
400mm/ 15 3/4"  
550mm/ 21 21/32"  
700mm/ 27 9/16"  
850mm/ 33 15/32"  
1.5m/ 4 15/16"

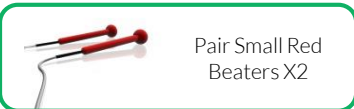

Ground Fix Components:



Spares available from [percussionplay.com](http://percussionplay.com) or from your local distributor

28 Kg

**Tools:**

- x1
- x1

Ground Fixed Duo  
Page 2 of 3



Instrument Components:

- x8
- x4
- x8
- x2
- x2

Thread Lock Solution Required (Not Supplied)

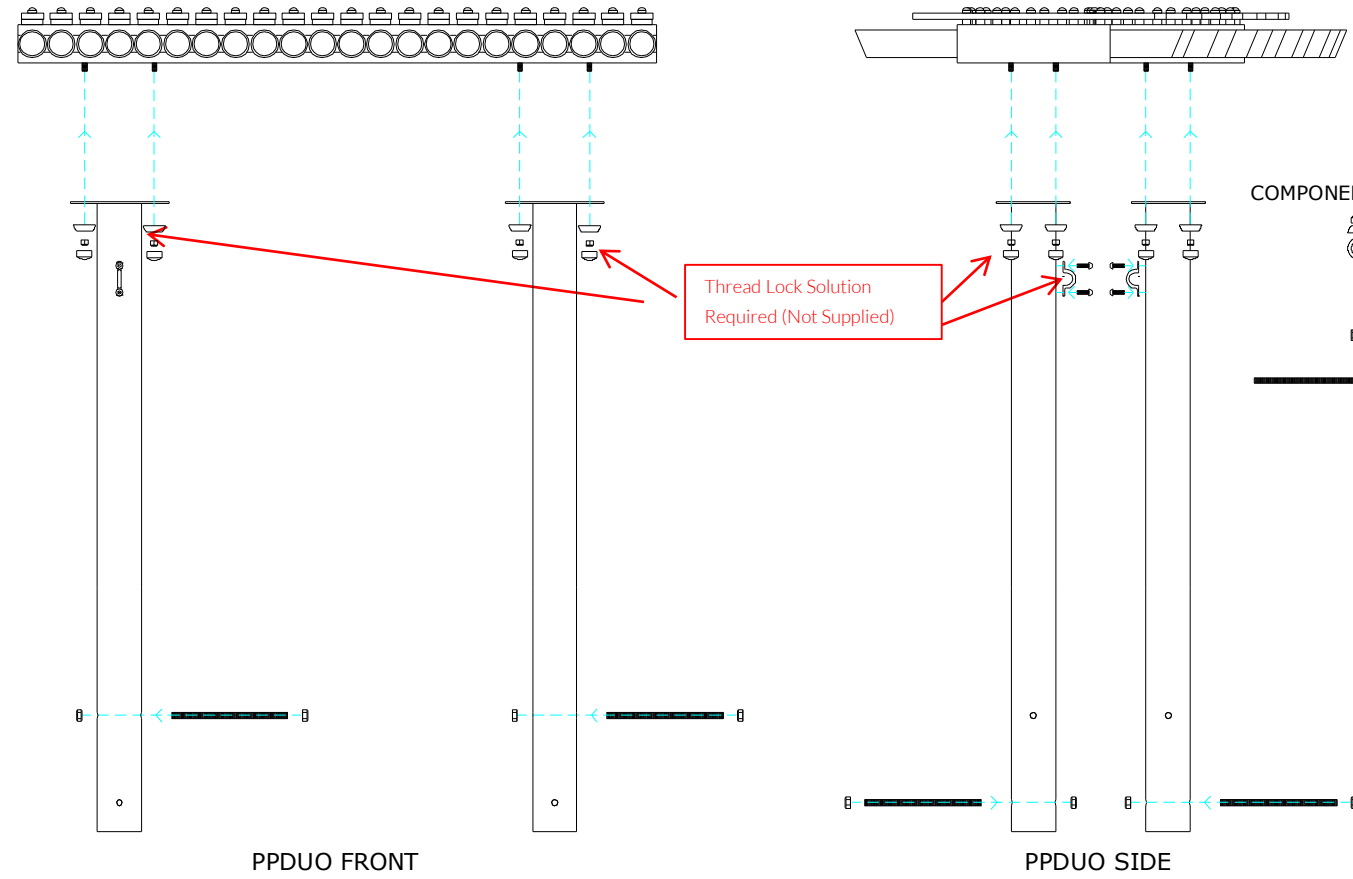

- COMPONENTS LIST:**
- 2 Part Cover Cap X8
  - M8 Nyloc nut X8
  - M10 Nut X8
  - M10x200 Threaded Bar X4
  - Saddle Strap X2
  - M6x20 Pin torx X4



Pair Small Red Beaters X2

Ground Fix Components:

- x4
- x8

Spares available from [percussionplay.com](http://percussionplay.com) or from your local distributor

28 Kg

# Ground Fix Post Installation

Foundations should not present a hazard. These foundations are recommended as a guide, for more information on foundation details for various surface see Part 7 of BS EN 1176.

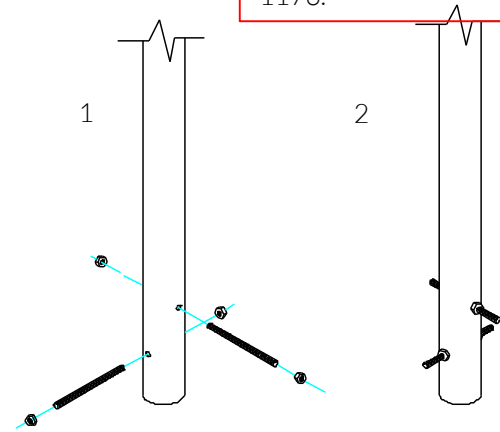

1  
Insert M10x 150 Threaded bar into pre drilled holes in Ground Fixing Post

2  
Fix M10x 200 Threaded bar in place using M10 Nuts

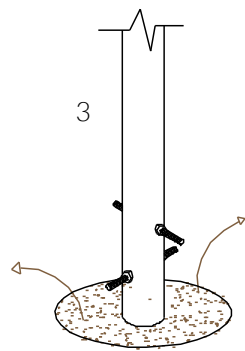

3  
Excavate 6 holes with a 250mm diameter tapering down to 350mm diameter and 450mm depth

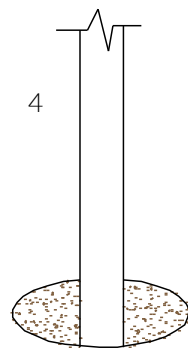

4  
Compact base of hole with 50mm of aggregate. Lower ground Fix post attached to instrument into hole (check instrument straight and level before filling with concrete)

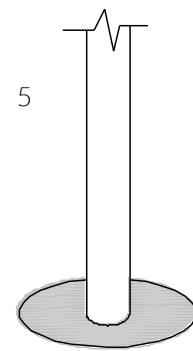

5  
Fix hole with fast drying concrete to manufacturers specifications.

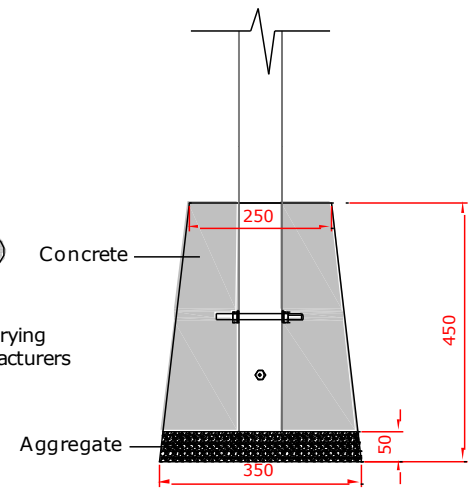

Duplicate points 1-5. Duo requires 2 Ground Fix Posts

400mm min depth

## Ground Fixed

Duo  
Page 3 of 3



### Components:



x4  
M10x200 Bolt



x8  
M10 Nut

Metric  
Conversion:  
50mm/ 2"  
250mm/ 10"  
350mm/ 14"  
400mm/ 16"  
450mm/ 18"



MADE IN BRITAIN

BS EN 1176

# Installation Instructions

## Ground Fixed

Congas  
Page 1 of 3

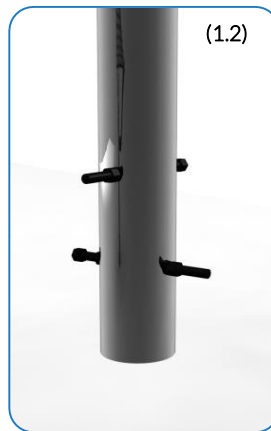
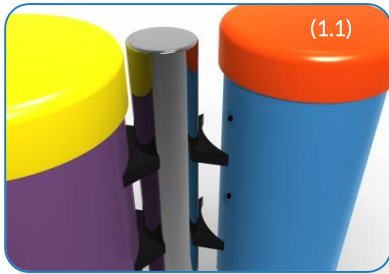

1. Attach the steel leg to each of the congas with the M10x50 security screws, square washers and PU mounts. (1.1) (See Assembly Guide)

2. Attach Ground Fixings to legs (1.2) (See Ground Fix Post Installation Sheet)

3. Excavate 1 hole for the Steel leg 250mm diameter by 300mm deep, in desired location upon decision from customer.



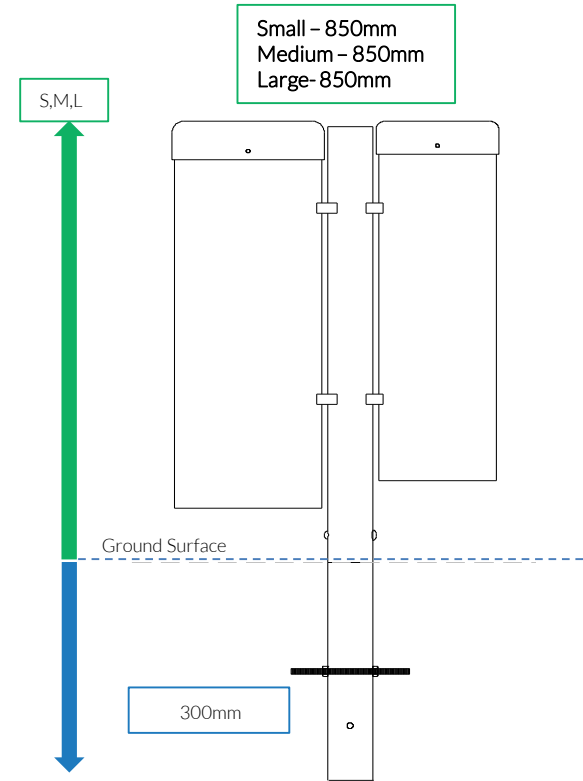
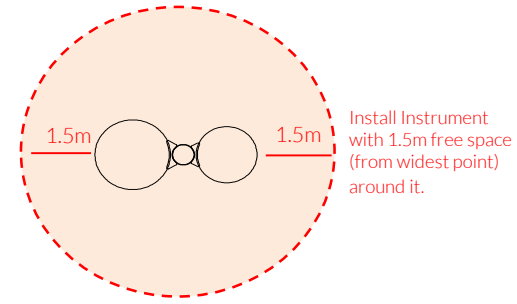

4. Locate (lower) legs into hole making sure they are vertical and level prior to concreting in place.

5. Once happy with location of the Instrument, fill hole using rapid hardening concrete. Be sure to compact concrete around legs and leave to dry according to manufactures guidelines.



Weight of heaviest part 3.8kg (Large drum Small Congas)  
Weight of heaviest part 4.5kg (Large drum Medium Congas)  
Weight of heaviest part 5.2kg (Large drum Large Congas)

### Instrument Components:

-  x4
- M10x50 Security Screw
-  x4
- M10x50x3 Square washer
-  x2
- PU 200 Mount
-  x2
- PU 250 Mount

Metric Conversion:  
250mm/ 10"  
400mm/ 16"  
850mm/ 33"  
1.5m/ 59"



### Ground Fix Components:

-  x2
- M10x200 Bolt
-  x4
- M10 Nut

Spares available from [percussionplay.com](http://percussionplay.com) or from your local distributor

14.8 Kg  
15 Kg  
20 Kg



# Assembly Guide PPCONG

Tools:

 x1  
TX 45 Driver Bit

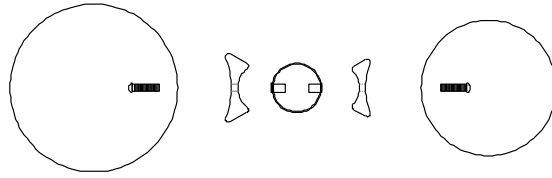

PPCONG PLAN

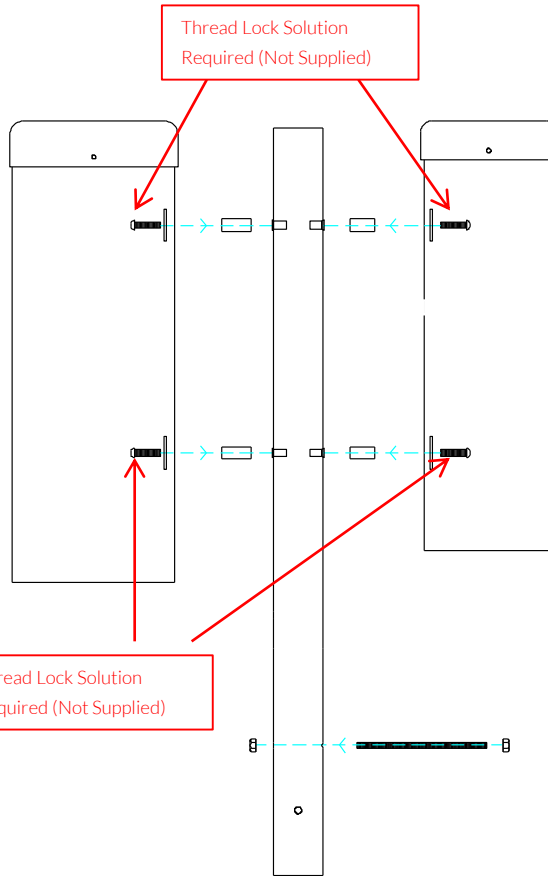





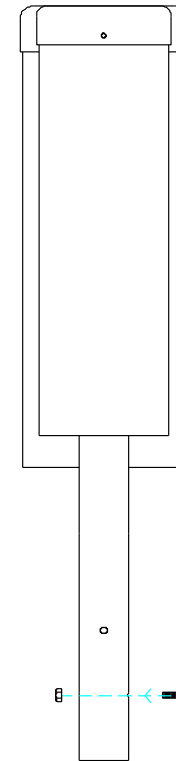

Thread Lock Solution  
Required (Not Supplied)

Thread Lock Solution  
Required (Not Supplied)



PPCONG SIDE

COMPONENTS LIST:

-  M10x50 Pin torx X4
-  M10x50x3 square washer X4
-  M10 Nut X4
-  M10x200 Threaded Bar X2
-  PU MOUNT 200 X2
-  PU MOUNT 250 X2





PPCONG FRONT

Ground Fixed

Congas  
Page 2 of 3



Instrument Components:

-  x4  
M10x50 Security Screw
-  x4  
M10x50x3 Square washer
-  x2  
PU 200 Mount
-  x2  
PU 250 Mount

Thread Lock Solution  
Required (Not Supplied)



Ground Fix  
Components:

-  x2  
M10x200 Bolt
-  x4  
M10 Nut

Spares available from  
[percussionplay.com](http://percussionplay.com) or from your  
local distributor

14.8 Kg  
15 Kg  
20 Kg

# Ground Fix Post Installation

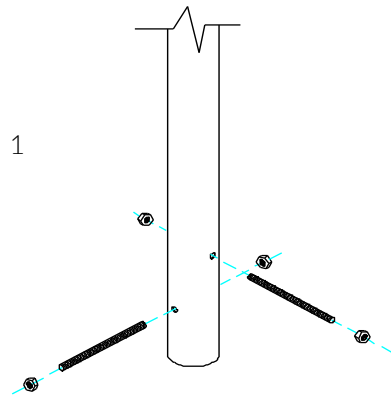

1  
Insert M10x 200 Threaded bar into pre drilled holes in Ground Fixing Post

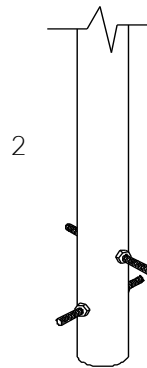

2  
Fix M10x 200 Threaded bar in place using M10 Nuts

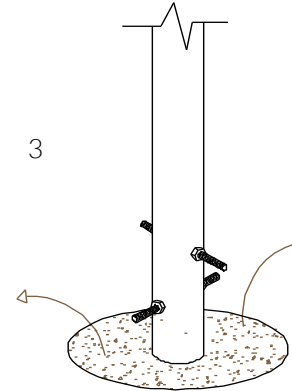

3  
Excavate a hole with a 250mm diameter tapering down to 350mm diameter and 350mm depth

Foundations should not present a hazard. These foundations are recommended as a guide, for more information on foundation details for various surface see Part 7 of BS EN 1176.

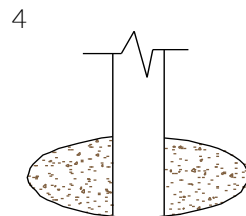

4  
Compact base of hole with 50mm of aggregate. Lower ground Fix post attached of instrument into hole (check instrument straight and level before filling with concrete)

300mm min depth

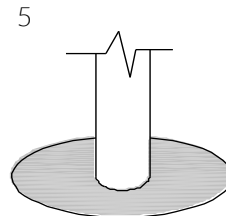

5  
Fill hole with fast drying concrete to manufacturers specifications.

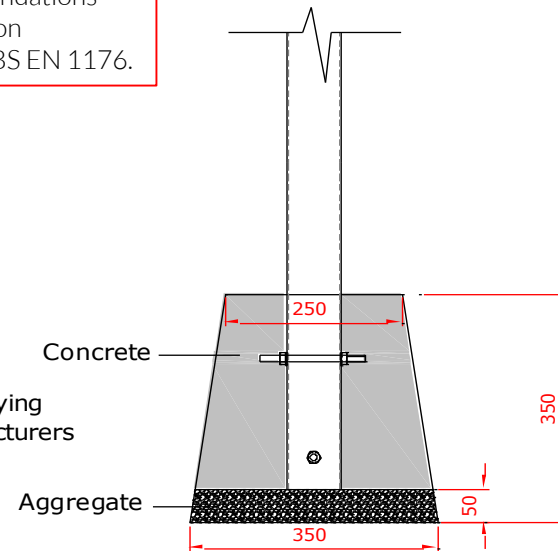

## Ground Fixed

Congas  
Page 3 of 3



## Components:



Metric Conversion:  
50mm/ 2"  
250mm/ 10"  
350mm/ 14"  
400mm/ 16"  
450mm/ 18"



# Installation Instructions

Ground Fixed  
Emperor Chimes  
Page 1 of 2

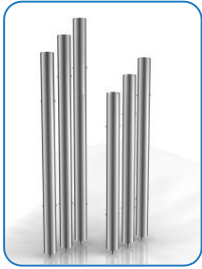

Instrument Components:

Emperor Chimes are pre-assembled

Metric Conversion:  
100mm/ 4"  
250mm/ 10"  
600mm/ 24"  
1.5m/ 59"  
1785mm/ 70"  
2490mm/ 98"

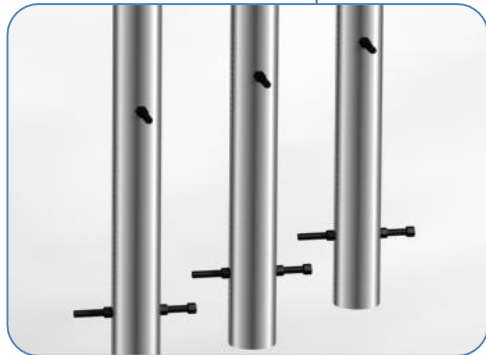
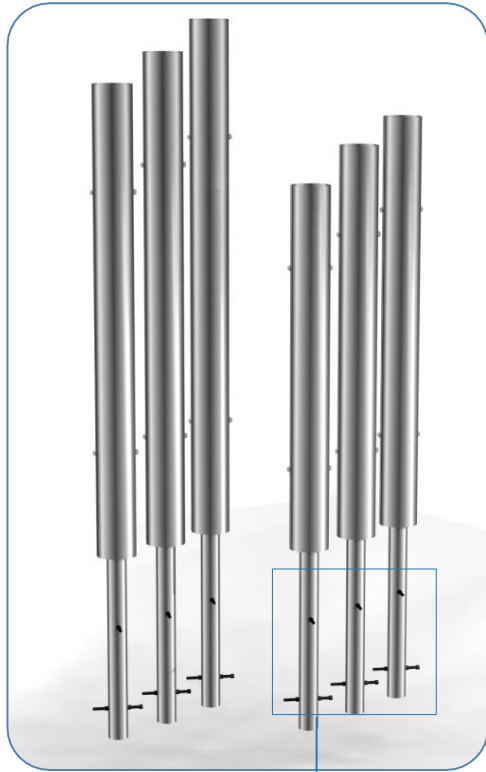

Weight of heaviest part 25kg (XL Chime)

1. Attach Ground Fixing posts to legs (1.2) (See Ground Fix Post Installation Sheet)

2. Excavate 6 holes for Emperor chimes 250mm diameter by 600mm deep in desired location upon decision from customer.

3. Locate (lower) legs into holes making sure they are vertical and level prior to concreting in place. Chimes should be 100mm from ground surface.

4. Once happy with location of the chimes, fill holes using rapid hardening concrete. Be sure to compact concrete around legs and leave to dry according to manufactures guidelines.

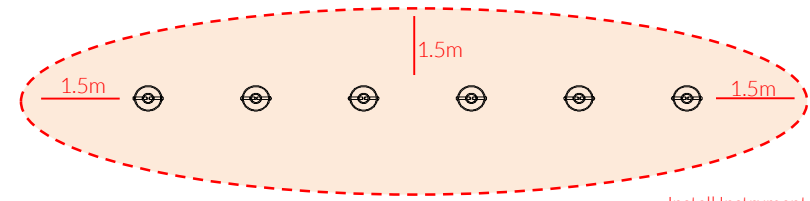

Install Instrument with 1.5m free space (from widest point) around it.

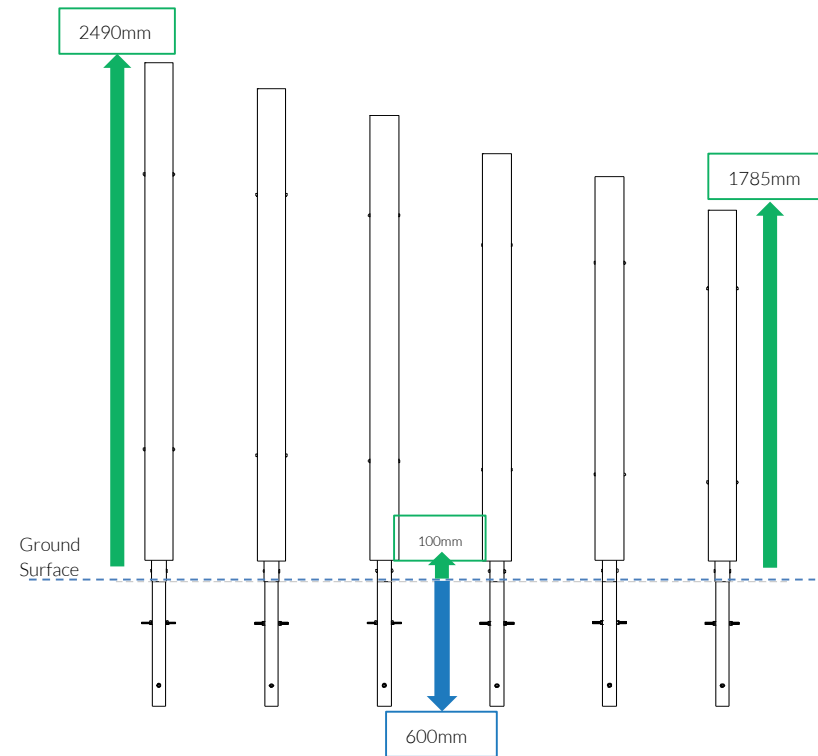

Ground Fix Components:

 x12  
M10x150 Bolt

 x24  
M10 Nut

 x6  
M10x50 Security Screw

 x6  
M10 Barrel Nut

Spares available from [percussionplay.com](http://percussionplay.com) or from your local distributor

117 Kg

# Ground Fix Post Installation

Foundations should not present a hazard. These foundations are recommended as a guide, for more information on foundation details for various surface see Part 7 of BS EN 1176.

**Tools:**

x2  
TX 45 Driver Bit

**Metric Conversion:**  
50mm/2"  
100mm/4"  
250mm/10"  
350mm/14"  
600mm/24"  
650mm/26"

**Ground Fixed**  
Emperor Chimes  
Page 2 of 2

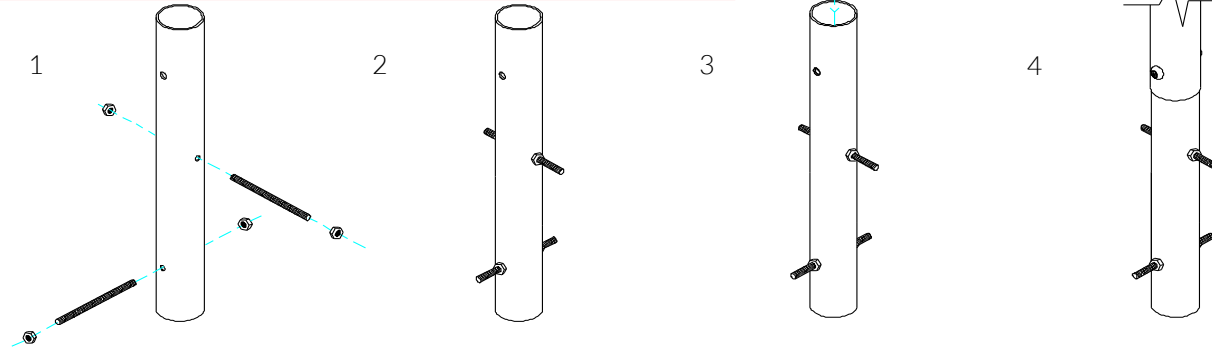
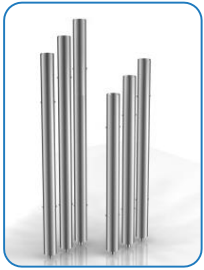

1 Insert M10x 150 Threaded bar into pre drilled holes in Ground Fixing Post

2 Fix M10x 150 Threaded bar in place using M10 Nuts

3 Locate the Ground fix Post into the leg of the instrument.

4 Fix instrument to Ground fix post using M10 bolt and Barrel Nut and use **thread locking solution** to prevent fixings working loose.

**Components:**

-  x12
-  x24
-  x6
-  x6

Thread Lock Solution Required (Not Supplied)

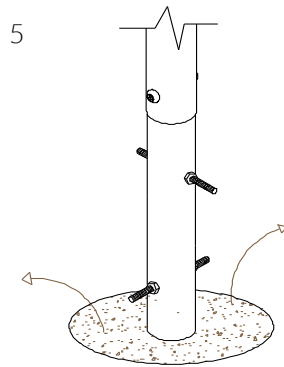

5 Excavate 6 holes with a 250mm diameter tapering down to 350mm diameter and 650mm depth

600mm max depth

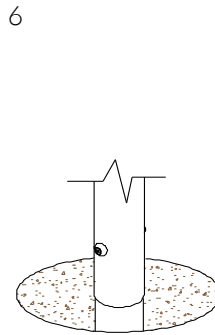

6 Compact base of hole with 50mm of aggregate. Lower ground Fix post attached to instrument into hole (check instrument straight and level before filling with concrete)

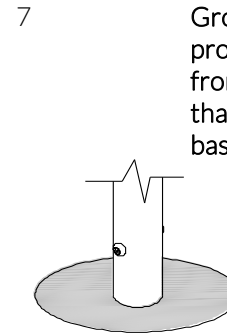

7 Fix hole with fast drying concrete to manufacturers specifications.

Ground fix tube protrudes 300mm from ground surface that inserts into the base of the chime post

