

Product technical sheet

FITNESS 1115

vinci
play



14+



< 140 kg



15,0 m2

Product data

Length	167 cm
Width	64 cm
Total height	166 cm
Age group	14+ years
Maximum weight of user	140 kg
Safety zone	15,0 m2
Free fall height	<60 cm
In accordance with norm EN	16630:2015
Weight of the heaviest part	18 kg
Dimensions of the largest part	45x20x150 cm
Availability of spare parts	YES
Installation time	1 h
Color options	

Data is subject to change without prior notice.

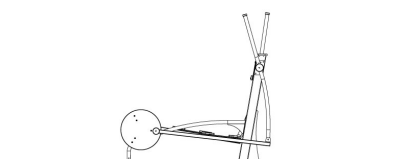
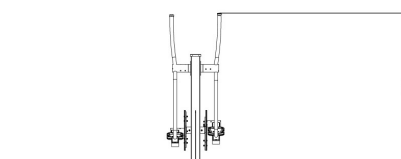
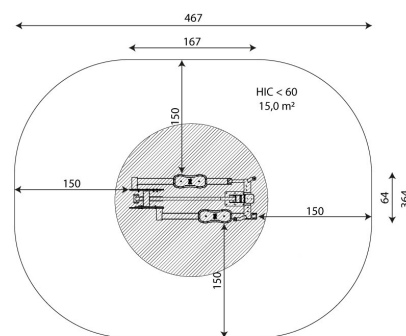
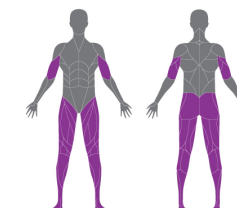
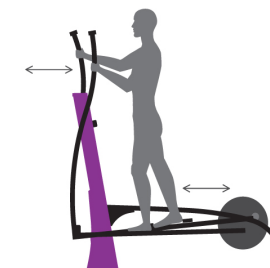

Vinci Sp. z o.o.
Seminaryjna 9 Street
99-400 Łowicz

VAT: 534-265-18-84
PHONE: +48 42 203 24 99 ext. 26
M: +48 793 404 991

17/12/2025

fitness

biuro@vinci-play.com
info@vinci-play.com
www.vinci-play.com

1 / 3

Material specification



Powder galvanized and powder-coated or stainless steel construction of 100 x 100 mm profile, durable end caps on the top of the structure made of plastic,



Steps made of durable, anti-slip and waterproof HPL plate, edges made of HDPE plate, resistant to weather conditions,



Polycarbonate exercise instructions information plate and phone holder made of durable HDPE plate, resistant to weather conditions,



Powder galvanized and powder coated steel or stainless steel bars,



Moving elements based on bearings mechanism closed in casing, which do not require periodic greasing and maintenance, ensuring long service life of the device,

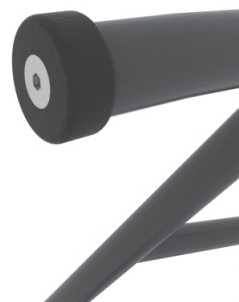

Safe end caps on the top of the bar, made of durable HDPE plate, resistant to weather conditions,

Additional information

- equipment adapted for the disabled; device intended for public outdoor gyms;
- equipment has a certificate issued by an accredited entity or a declaration of conformity;
- no sharp edges or chinks that would pose a danger of jamming the head, fingers or any other body parts;
- anchoring on flat surface, 80/70 cm deep;
- render is for reference only, the actual appearance of the equipment and its color may vary;

Guarantee

30 30 year guarantee - Durability of steel and stainless steel structural elements

15 15 year guarantee - Durability of steel and stainless steel structures of mobile devices; durability of Robinia wood structural elements

10 10 year guarantee - Structural strength of HDPE, 100% recycled HDPE and HPL elements; structural elements made of 100% recycled material (composite)

5 5 year guarantee - Corrosion resistance of stainless steel and hot-dip galvanized and powder-coated steel elements, resistance to bark beetles and rotting of wooden structural elements

Detailed information in the guarantee card

Vinci Sp. z o.o.
Seminaryjna 9 Street
99-400 Łowicz

VAT: 534-265-18-84
PHONE: +48 42 203 24 99 ext. 26
M: +48 793 404 991

fitness

biuro@vinci-play.com
info@vinci-play.com
www.vinci-play.com

Amount of safe surface corresponding with free fall height:

HIC <60 15,0 m²

Data is subject to change without prior notice.

Surfaces according to EN 16630:2015

	Description (mm)	Layer thickness (cm)	Maximum fall height (cm)
Concrete / stone / bituminous surfaces (A, B, C)	-	-	≤100
outer soil layer (A,B,C)	-	-	≤120
Turf (A,B,C)	-	-	≤150
bark (A,C)	Particle size from 20 to 80	30	≤200
		40	≤300
wood shavings/cuttings (A, C)	Particle size from 5 to 30	30	≤200
		40	≤300
sand (A,C)	Particle size from 0,2 to 2 mm	30	≤200
		40	≤300
gravel (A,C)	Particle size from 2 to 8	30	≤200
		40	≤300
attested synthetic (A, B, C)	Tested according to EN 1177		<60

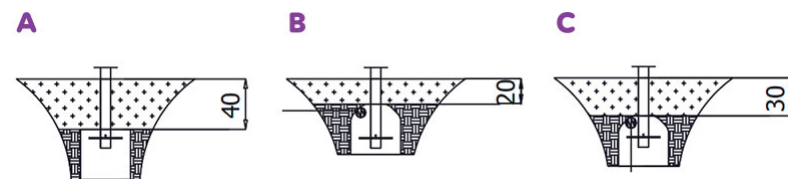

Vinci Sp. z o.o.
Seminaryjna 9 Street
99-400 Łowicz

VAT: 534-265-18-84
PHONE: +48 42 203 24 99 ext. 26
M: +48 793 404 991

fitness

biuro@vinci-play.com
info@vinci-play.com
www.vinci-play.com