

JUMPOO 2221



4 - 15 years



4 kids



41,2 m²

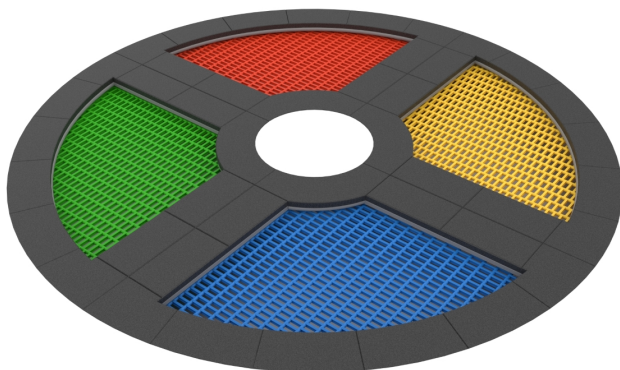

Material specification

- Construction made of hot-dip galvanised steel, mounted below the ground surface,
- The edges of the structure covered with a rubber rim SBR glued to the frame or without rubber rim,
- Jumping mat: made of polypropylene lamellas, threaded on a stainless steel rope,
- Fastening on durable galvanized springs inside the structure,



Physical development



balance



community



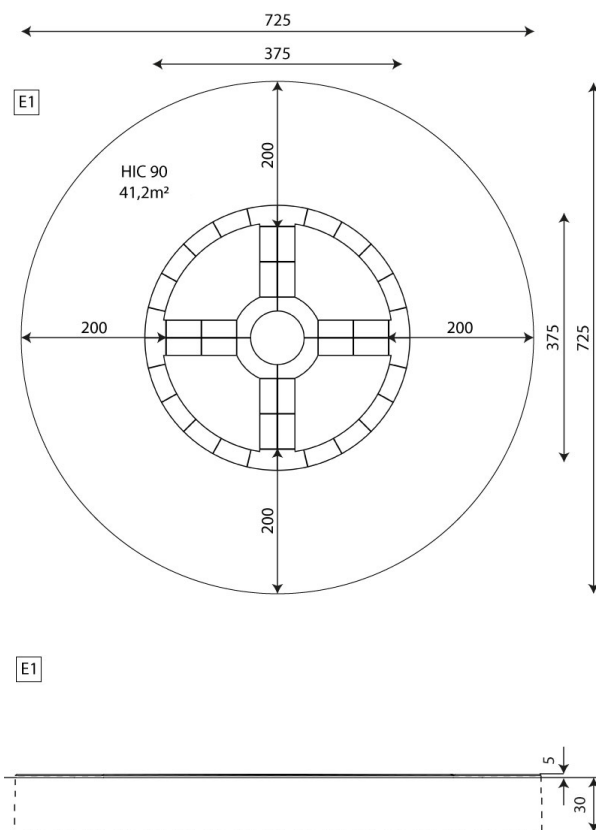

Product technical sheet

JUMPOO 2221

Product data

Length	375 cm
Width	375 cm
Total height	5 cm
Age group	4 - 15 years
Number of users	4 kids
Safety zone	41,2 m ²
Free fall height	90 cm
In accordance with norm EN	1176-1:2017+A1:2023
Weight of the heaviest part	120 kg
Dimensions of the largest part	150x150x31 cm
Availability of spare parts	YES
Installation time	8 h
Color options	

Data is subject to change without prior notice.

Additional information

- equipment intended for public playgrounds;
- equipment has a certificate issued by an accredited entity or a declaration of conformity;
- no sharp edges or chinks that would pose a danger of jamming the head, fingers or any other body parts;
- anchoring on flat surface, 30 cm deep;
- render is for reference only, the actual appearance of the equipment and its color may vary;

Guarantee

30

30 year guarantee - Durability of steel and stainless steel structural elements

15

15 year guarantee - Durability of steel and stainless steel structures of mobile devices; durability of Robinia wood structural elements

10

10 year guarantee - Structural strength of HDPE, 100% recycled HDPE and HPL elements; structural elements made of 100% recycled material (composite)

5

5 year guarantee - Corrosion resistance of stainless steel and hot-dip galvanized and powder-coated steel elements, resistance to bark beetles and rotting of wooden structural elements

Detailed information in the guarantee card



Surfaces according to EN 1176-1:2017+A1:2023

	Description (mm)	Layer thickness (cm)	Maximum fall heights (cm)
Turf/ top layer of soil (A,B,C)	-	-	≤100
bark (A,C)	Particle size from 20 to 80	30	≤200
		40	≤300
woodchips (A,C)	Particle size from 5 to 30	30	≤200
		40	≤300
sand or gravel (A,C)	Particle size from 0,25 to 8	30	≤200
		40	≤300
synthetic attested (A,B,C)	Tested according to EN 1177		90

Product technical sheet

JUMPOO 2221

Amount of safe surface corresponding with free fall height:

HIC 90 41,2 m²

Data is subject to change without prior notice.

