

CLIMBOO WD0454

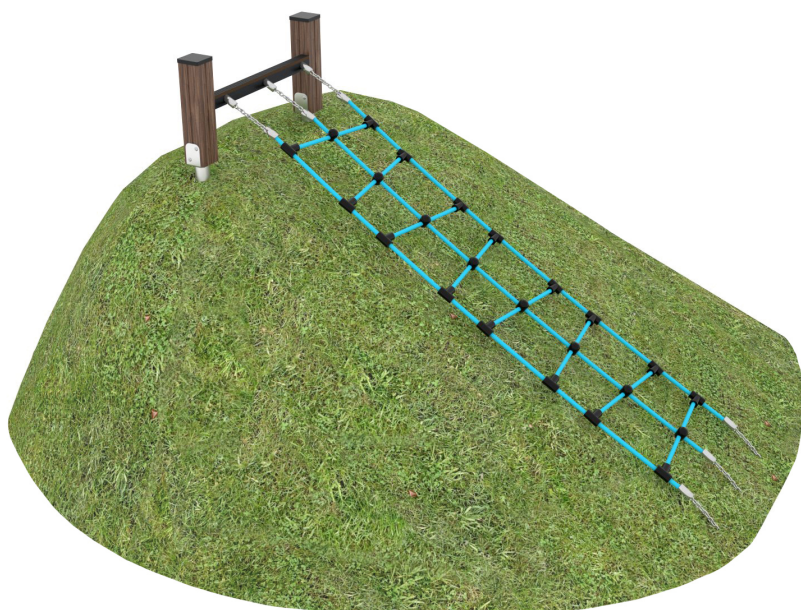

3 - 14 years



4 kids



17,8 m²

Material specification

- Construction made of the highest quality laminated, impregnated and double coated pine wood 90 x 90 mm without knots, secured from the top with polypropylene plugs,
- Metal anchors made of hot dip galvanized steel, protecting the wood from direct contact with the ground to prevent rot and to extend the product's life,
- Stainless steel construction elements,
- Steel ropes in polypropylene braid, connected with durable plastic elements, stainless steel or aluminum,
- Calibrated stainless steel chains, preventing fingers entrapment,
- Screws covered with plastic caps and/or stainless steel screws,
- Safe end caps made of polypropylene,



Physical development



balance



climbing



community



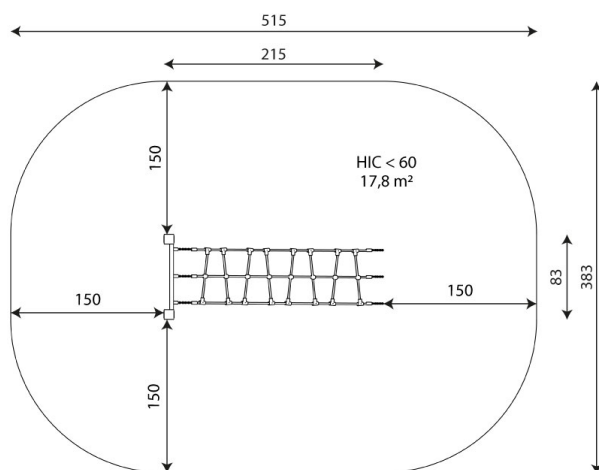

17,8 m²

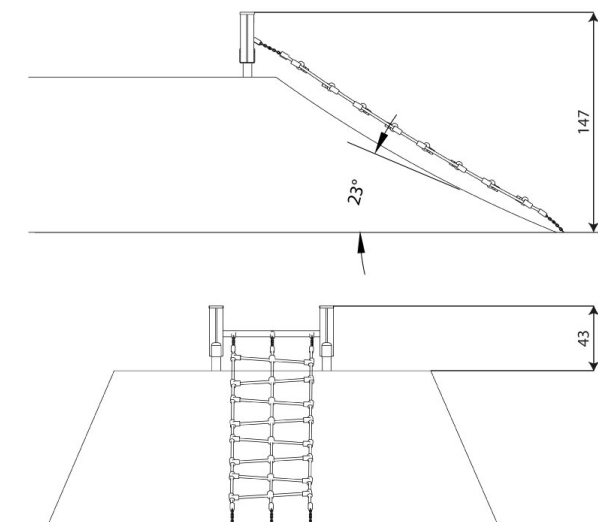

Product technical sheet

CLIMBOO WD0454

Product data

Length	215 cm
Width	83 cm
Total height	147 cm
Age group	3 - 14 years
Number of users	4 kids
Safety zone	17,8 m ²
Free fall height	<60 cm
In accordance with norm EN	1176-1:2017+A1:2023
Availability of spare parts	YES

Data is subject to change without prior notice.

Additional information

- equipment intended for public playgrounds;
- equipment has a certificate issued by an accredited entity or a declaration of conformity;
- no sharp edges or chinks that would pose a danger of jamming the head, fingers or any other body parts;
- anchoring on flat surface, 80/70/60 cm deep;
- the device adapted for installation on flat terrain and slopes; the maximum allowable slope inclination angle is 45 degrees;
- render is for reference only, the actual appearance of the equipment and its color may vary;

Guarantee

30

30 year guarantee - Durability of steel and stainless steel structural elements

15

15 year guarantee - Durability of steel and stainless steel structures of mobile devices; durability of Robinia wood structural elements

10

10 year guarantee - Structural strength of HDPE, 100% recycled HDPE and HPL elements; structural elements made of 100% recycled material (composite)

5

5 year guarantee - Corrosion resistance of stainless steel and hot-dip galvanized and powder-coated steel elements, resistance to bark beetles and rotting of wooden structural elements

Detailed information in the guarantee card



Surfaces according to EN 1176-1:2017+A1:2023

	Description (mm)	Layer thickness (cm)	Maximum fall heights (cm)
Turf/ top layer of soil (A,B,C)	-	-	≤100
bark (A,C)	Particle size from 20 to 80	30	≤200
		40	≤300
woodchips (A,C)	Particle size from 5 to 30	30	≤200
		40	≤300
sand or gravel (A,C)	Particle size from 0,25 to 8	30	≤200
		40	≤300
synthetic attested (A,B,C)	Tested according to EN 1177		<60

Product technical sheet

CLIMBOO WD0454

Amount of safe surface corresponding with free fall height:

HIC <60 17,8 m²

Data is subject to change without prior notice.

